

DORMER  **PRAMET**

HOLEMAKING 2021 – 2022

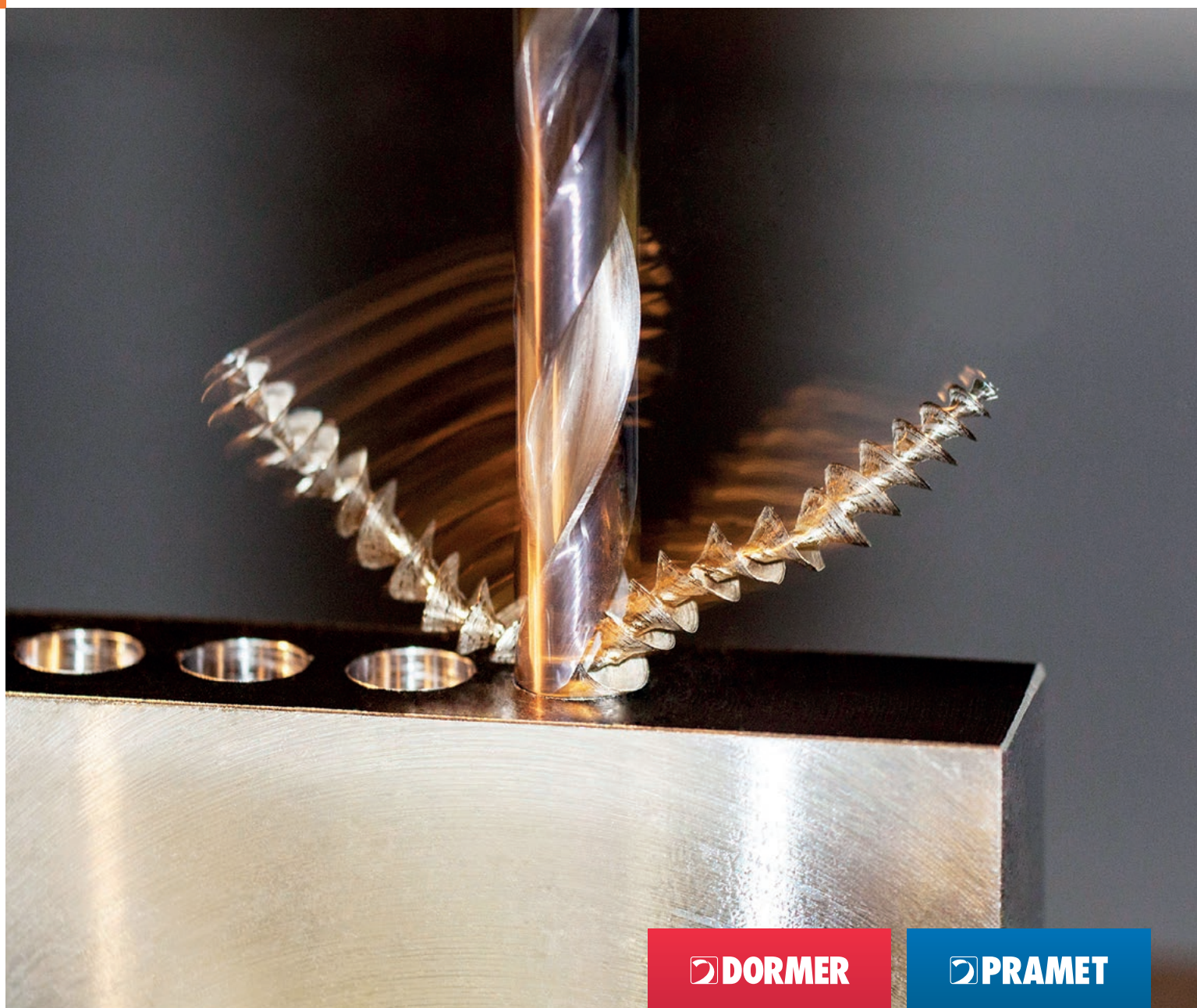

 **DORMER**

 **PRAMET**



HOLEMAKING – GENERAL CONTENT

6	DRILLS	WMG & ISO 13399
12		INSTRUCTIONS
15		SOLID CARBIDE DRILLS
66		HSS DRILLS
176		TECHNICAL INFORMATION
186		CUTTING FLUIDS
190		REAMERS AND COUNTERSINKS
264	INDEXABLE DRILLS	INSTRUCTIONS
271		HYDRA DRILLS
297		TECHNICAL INFORMATION
307		INDEXABLE DRILLS
327		TECHNICAL INFORMATION
350	BORING SYSTEMS	INSTRUCTIONS
359		BORING HEADS
376		BORING ACCESSORIES
381		INSERTS
404		ARBORS
418		BORING KITS
429		TECHNICAL INFORMATION



PRODUCT FAMILY		PRODUCT FAMILY		PRODUCT FAMILY		PRODUCT FAMILY	
A		A243	120	B180	216	H	
A002	96	A244	121	B301	211	H851	287
A002S	98	A266	158	B334	208	H8512	294
A022	82	A295	172	B335	209	H853	289
A080	169	A296	173	B400	200	H855	291
A087	166	A345	146	B411	204	H858	293
A088	165	A350	144	B441	203	H860	295
A089	167	A400	150	B442	205	H861	296
A094	166	A402	151	B481	201	M	
A095	165	A405	152	B901	210	M150	173
A099	168	A412	153	B903	212	M151	174
A100	99	A413	154	B952	213	M152	174
A101	103	A510	111	B953	215	M200-1	187
A108	104	A520	88	B954	225	M200-2	187
A110	122	A530	140	B955	226	M200-3	188
A117	86	A553	113	B956	227	R	
A119	77	A620	84	B957	228	R100	34
A120	80	A720	91	G		R120	32
A122	78	A723	76	G106	238	R122	27
A123	79	A730	141	G107	242	R123	28
A124	90	A777	108	G125	249	R125	29
A125	128	A900	114	G129	234	R200	26
A130	134	A901	116	G132	244	R453	52
A147	106	A920	92	G135	230	R454	48
A160	110	A921	94	G136	236	R457	44
A166	143	A940	124	G137	232	R458	40
A170	118	A941	126	G138	245	R459	56
A188	172	A951	148	G142	240	R463	62
A190	170	A952	149	G149	235	R467	59
A191	171	A976	130	G154	233	R510	38
A199	169	A977	132	G171	247	R520	36
A200	155	A978	133	G236	250	R6011	30
A201	160	B		G314	248	R7131	31
A205	156	B100	206	G335	231	R950	281
A206	157	B101	222	G338	246	R960	283
A210	159	B121	224	G400	229	R970	285
A225	161	B122	214	G506	239		
A237	162	B157	220	G560	237		
A238	163	B161	221	G570	241		
A242	164	B170	218	G600	243		



PRODUCT FAMILY		PRODUCT FAMILY		PRODUCT FAMILY		PRODUCT FAMILY	
Z		BS 54 KIT TC 8-210	427	F		L	
2080-BS	411	BT-BS	408	F75	367	LA-BS	417
69871-BS	406	C		F75-BB	369	M	
802D	313	CART-BS-SPC	378	F75-C	368	MB-H	373
803D	315	CART-BS-STD	379	F90	370	MOR-BS	413
804D	318	D		F90-BB	372	R	
805D	320	D75	361	F90-C	371	RED-BS	416
B		D75-BB	363	H		W	
BS 54 KIT RC 8-043	420	D75-C	362	HSK-BS	410	WEL-BS	414
BS 54 KIT RC 8-100	421	D90	364	CH			
BS 54 KIT RC 8-170	422	D90-BB	366	CHAM-BS	380		
BS 54 KIT RC 8-210	423	D90-C	365	I			
BS 54 KIT TC 8-043	424	E		ISO BARS	374		
BS 54 KIT TC 8-100	425	EP	322	ISO BARS A042	375		
BS 54 KIT TC 8-170	426	EXT-BS	415				

PRODUCT FAMILY		PRODUCT FAMILY	
C		S	
CCGT	388	SCET	323
CCGW CBN	390	T	
CCMT	390	TCGT	401
CCMW	393	TCMT	402
CNGA CBN	394	TCMW	403
CNGG	395	W	
CNMA	395	WCMT-ID	325
CNMG	396	WCMX	326
D		X	
DCMT	398	XPET	324
DCMW	399		
DCMW PCD	399		
E			
EPGX	400		
EPMT	400		



POCKET SAVER

Our machining calculator allows you to measure the savings based on different products and applications. A useful pocket-sized tool, which will help keep cash in your pockets! **Simply Reliable.**

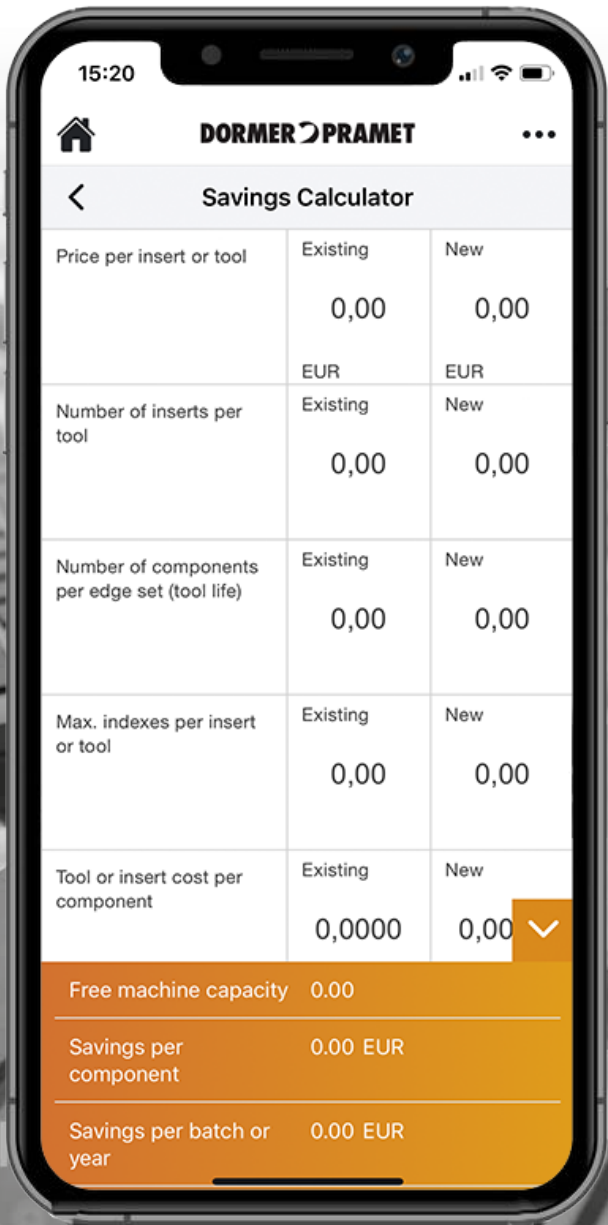



HOLEMAKING – GENERAL CONTENT

6		WMG & ISO 13399
12	DRILLS	INSTRUCTIONS
15		SOLID CARBIDE DRILLS
66		HSS DRILLS
176		TECHNICAL INFORMATION
186		CUTTING FLUIDS
190		REAMERS AND COUNTERSINKS
264	INDEXABLE DRILLS	INSTRUCTIONS
271		HYDRA DRILLS
297		TECHNICAL INFORMATION
307		INDEXABLE DRILLS
327		TECHNICAL INFORMATION
350	BORING SYSTEMS	INSTRUCTIONS
359		BORING HEADS
376		BORING ACCESSORIES
381		INSERTS
404		ARBORS
418		BORING KITS
429		TECHNICAL INFORMATION



WORKPIECE MATERIAL GROUPS (WMG)

ISO To select a cutting grade and geometry for a broad range of workpiece materials

General definition
i.e. Steel, Stainless Steel...

P **M** **K** **N** **S** **H**

Subgroup To navigate and select a tool by suitability for a more specific range of workpiece materials

Definition by structure/composition
i.e. Plain Carbon Steel, Alloy Steel...

P **M** **K** **N** **S** **H**

P1

P2

P3

P4

WMG To select and provide cutting conditions within a bandwidth of $\pm 10\%$

Definition by hardness/ultimate tensile strength
i.e. $160 < 220 \text{ HB}$, $620 < 900 \text{ N/mm}^2 \dots$

P

P1 **P1.1** **P1.2** **P1.3**

P2 **P2.1** **P2.2** **P2.3**

P3 **P3.1** **P3.2** **P3.3**

P4 **P4.1** **P4.2** **P4.3**

ABOUT DORMER PRAMET'S WORKPIECE MATERIAL CLASSIFICATION

Workpiece **Material Groups (WMG)** are used to support easy and reliable selection of the right cutting tool and starting values for machining conditions in particular applications.

Dormer Pramet classifies workpiece materials into six different coloured groups;

- **Blue:** Steel and cast steel (P-group)
- **Yellow:** Stainless steel (M-group)
- **Red:** Cast iron (K-group)
- **Green:** Non-ferrous metals (N-group)
- **Brown:** High-temperature alloys (S-group)
- **Grey:** Hardened materials (H-group)

Each of these are divided into subgroups on the basis of their structure and/or composition. For example, P-group steel and cast steel is split into four subgroups, namely;

- **P1** – Free machining steel
- **P2** – Plain carbon steel
- **P3** – Alloy steel
- **P4** – Tool steel

A final division includes material properties, such as hardness and ultimate tensile strength. This is to provide our customers with a complete tool recommendation, including starting values for cutting speed and feed.

The table on the next page includes a description of each workpiece material group, as well as examples of commonly used designations.



WMG (WORK MATERIAL GROUP)

ISO group	WMG (Work Material Group)	Hardness (HB or HRC)	Ultimate Tensile Strength (MPa)			
P	P1	P1.1	Sulfurized	< 240 HB	≤ 830	
		P1.2	Free machining steel	Sulfurized and phosphorized	< 180 HB	≤ 620
		P1.3	(carbon steels with increased machinability)	Sulfurized/phosphorized and leaded	< 180 HB	≤ 620
	P2	P2.1	Plain carbon steel (steels comprised of mainly iron and carbon)	Containing <0.25 % C	< 180 HB	≤ 620
		P2.2		Containing <0.55 % C	< 240 HB	≤ 830
		P2.3		Containing >0.55 % C	< 300 HB	≤ 1030
	P3	P3.1	Alloy steel (carbon steels with an alloying content ≤ 10%)	Annealed	< 180 HB	≤ 620
		P3.2		Hardened and tempered	180 – 260 HB	> 620 ≤ 900
		P3.3			260 – 360 HB	> 900 ≤ 1240
	P4	P4.1	Tool steel (special alloy steel for tools, dies and molds)	Annealed	< 26 HRC	≤ 900
P4.2		Hardened and tempered		26 – 39 HRC	> 900 ≤ 1240	
P4.3				39 – 45 HRC	> 1240 ≤ 1450	
M	M1	M1.1	Ferritic stainless steel (straight chromium non-hardenable alloys)	< 160 HB	≤ 520	
		M1.2		160 – 220 HB	> 520 ≤ 700	
	M2	M2.1	Martensitic stainless steel (straight chromium hardenable alloys)	Annealed	< 200 HB	≤ 670
		M2.2		Quenched and tempered	200 – 280 HB	> 670 ≤ 950
		M2.3		Precipitation-hardened	280 – 380 HB	> 950 ≤ 1300
	M3	M3.1	Austenitic stainless steel (chromium-nickel and chromium-nickel-manganese alloys)	< 200 HB	≤ 750	
		M3.2		200 – 260 HB	> 750 ≤ 870	
		M3.3		260 – 300 HB	> 870 ≤ 1040	
	M4	M4.1	Austenitic-ferritic (DUPLEX) or super-austenitic stainless steel	< 300 HB	≤ 990	
		M4.2		Precipitation hardening austenitic stainless steel	300 – 380 HB	≤ 1320
K	K1	K1.1	Gray iron or Automotive Gray iron (GG) (iron-carbon castings with a lamellar graphite microstructure)	Ferritic or ferritic-pearlitic	< 180 HB	≤ 190
		K1.2		Ferritic-pearlitic or pearlitic	180 – 240 HB	> 190 ≤ 310
		K1.3		Pearlitic	240 – 280 HB	> 310 ≤ 390
	K2	K2.1	Malleable iron (GTS/GTW) (iron-carbon castings with a graphite-free microstructure)	Ferritic	< 160 HB	≤ 400
		K2.2		Ferritic or pearlitic	160 – 200 HB	> 400 ≤ 550
		K2.3		Pearlitic	200 – 240 HB	> 550 ≤ 660
	K3	K3.1	Ductile iron (GGG) (iron-carbon castings with a nodular graphite microstructure)	Ferritic	< 180 HB	≤ 560
		K3.2		Ferritic or pearlitic	180 – 220 HB	> 560 ≤ 680
		K3.3		Pearlitic	220 – 260 HB	> 680 ≤ 800
	K4	K4.1	Austenitic gray iron (ASTM A436) (iron-carbon alloy castings with an austenitic lamellar graphite microstructure)	< 180 HB	≤ 190	
		K4.2		Austenitic ductile iron (ASTM A439 or ASTM A571) (iron-carbon alloy castings with an austenitic nodular graphite microstructure)	< 240 HB	≤ 740
		K4.3		Austempered ductile iron (ASTM A897) (iron-carbon alloy castings with an ausferrite microstructure)	< 280 HB	> 840 ≤ 980
		K4.4			280 – 320 HB	> 980 ≤ 1130
		K4.5			320 – 360 HB	> 1130 ≤ 1280
	K5	K5.1	Compacted graphite iron CGI (ASTM A842) (iron-carbon castings with a vermicular graphite structure)	Ferritic	< 180 HB	≤ 400
K5.2		Ferritic-pearlitic		180 – 220 HB	> 400 ≤ 450	
K5.3		Pearlitic		220 – 260 HB	> 450 ≤ 500	
N	N1	N1.1	Commercially pure wrought aluminium	< 60 HB	≤ 240	
		N1.2		Half hard tempered	60 – 100 HB	> 240 ≤ 400
		N1.3		Full hard tempered	100 – 150 HB	> 400 ≤ 590
	N2	N2.1	Cast aluminium alloys	< 75 HB	≤ 240	
		N2.2		75 – 90 HB	> 240 ≤ 270	
		N2.3		90 – 140 HB	> 270 ≤ 440	
	N3	N3.1	Free-cutting copper-alloys materials with excellent machining properties	–	–	
		N3.2		Short-chip copper-alloys with good to moderate machining properties	–	–
		N3.3		Electrolytic copper and long-chip copper-alloys with moderate to poor machining properties	–	–
	N4	N4.1	Reinforced polymers or composites	–	–	
		N4.2		Thermoplastic polymers	–	–
		N4.3		Thermosetting polymers	–	–
	N5	N5.1	Graphite	–	–	
	S	S1	S1.1	Titanium or titanium alloys	< 200 HB	≤ 660
			S1.2		200 – 280 HB	> 660 ≤ 950
S1.3			280 – 360 HB		> 950 ≤ 1200	
S2		S2.1	Fe-based high-temperature alloys	< 200 HB	≤ 690	
		S2.2		200 – 280 HB	> 690 ≤ 970	
S3		S3.1	Ni-based high-temperature alloys	< 280 HB	≤ 940	
		S3.2		280 – 360 HB	> 940 ≤ 1200	
S4		S4.1	Co-based high-temperature alloys	< 240 HB	≤ 800	
	S4.2	240 – 320 HB		> 800 ≤ 1070		
H	H1	H1.1	Chilled cast iron	< 440 HB	–	
		H1.2		< 55 HRC	–	
	H2	H2.1	Hardened cast iron	> 55 HRC	–	
		H2.2		< 51 HRC	–	
	H3	H3.1	Hardened steel <55 HRC	51 – 55 HRC	–	
		H3.2		< 55 HRC	–	
H4	H4.1	Hardened steel >55 HRC	55 – 59 HRC	–		
	H4.2		> 59 HRC	–		



CUTTING TOOL PARAMETERS ACCORDING TO ISO 13399

All cutting tools are defined by a number of parameters according to the standard ISO 13399. This list contains all the parameters used in this catalogue and their definitions.

ISO 13399 is an international cutting tool information standard. It provides dimensions and parameters in a neutral format that is independent of any particular system or company nomenclature. When cutting tools are clearly defined according to a global standard, all types of software can process the electronic data more quickly, improving the quality of communication and helping to make the exchange of information run smoothly. Supporting a common language in our cutting tool descriptions this will assist system to system communication. It will save you a significant amount of time, providing an easier gathering of high-quality data across our 40,000 solid and indexable tools. By using an ISO 13399 compliant system, there will be no need to manually interpret data and key-enter it into your system.

EXAMPLES ONLY!

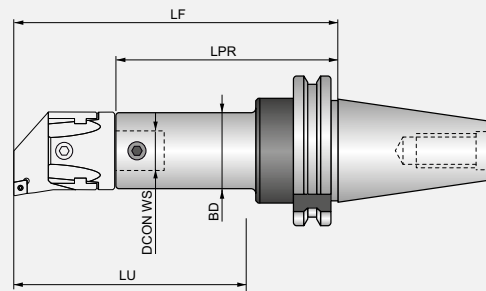
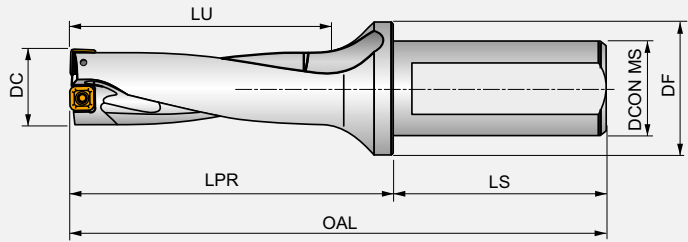
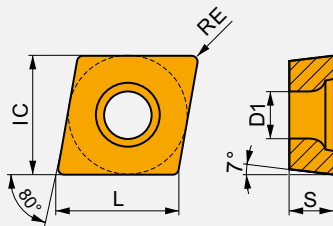
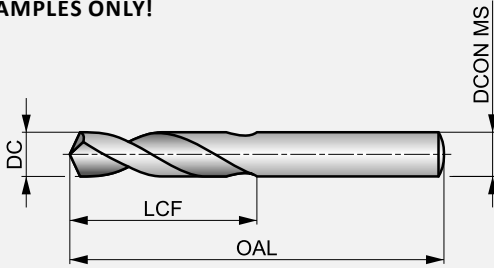

ISO 13399	description
BD	Body diameter
BDX	Body diameter maximum
CZC MS	Connection size code machine side
D1	Fixing hole diameter
DC	Cutting diameter
DCN	Cutting diameter minimum
DCON MS	Connection diameter machine side
DCON WS	Connection diameter workpiece side
DCX	Cutting diameter maximum
DHUB	Hub diameter
FLGT	Flange thickness
IC	Inscribed circle diameter
L	Cutting edge length
LB	Body length
LF	Functional length
LPR	Protruding length
LU	Usable length
OAL	Overall length
RE	Corner radius
S	Insert thickness
WF	Functional width
APMX	Depth of cut maximum
D1	Fixing hole diameter
DC_1	Cutting diameter first cutting step
DC_2	Cutting diameter second cutting step

ISO 13399	description
DF	Flange diameter
DH	Head diameter
GPD	Guide pilot diameter
GPL	Guide pilot length
H	Shank height
HSD	Size of drive part
IC	Inscribed circle diameter
LCF	Length chip flute
LCOL	Collet length
LDC	Distance reference point PK
LH	Head length
LS	Shank length
LSC	Clamping length
NOF	Number of flutes
PLGL	Plug length
RCSK	Radius countersunk
RE	Corner radius
SDI	Step diameter increments
SDL	Step diameter length
SDL_1	Step diameter length first cutting step
SDL_2	Step diameter length second cutting step
TDZ	Thread diameter size
THLGTH	Thread length
WSC	Clamping width



DORMER PRAMET



YOUR PERSONAL LIBRARY

Always revisiting the same sections of our publications? Our library app allows you to save key pages that you can revert back to again and again, whenever you need to. Simply Reliable. **Simply Reliable.**





SOLID CARBIDE DRILLS
HSS DRILLS





HOLEMAKING – GENERAL CONTENT

6		WMG & ISO 13399
12	DRILLS	INSTRUCTIONS
15		SOLID CARBIDE DRILLS
66		HSS DRILLS
176		TECHNICAL INFORMATION
186		CUTTING FLUIDS
190		
264	INDEXABLE DRILLS	INSTRUCTIONS
271		HYDRA DRILLS
295		TECHNICAL INFORMATION
307		INDEXABLE DRILLS
327		TECHNICAL INFORMATION
350	BORING SYSTEMS	INSTRUCTIONS
359		BORING HEADS
376		BORING ACCESSORIES
381		INSERTS
404		ARBORS
418		BORING KITS
429		TECHNICAL INFORMATION



1 R100



Solid Carbide Jobber Drill, Bright Finish

Improved wear resistance for increased productivity and extended tool life. A 120°, 4-facet point helps with self-centering and reduces cutting forces. Can be used with all CNC machine applications.

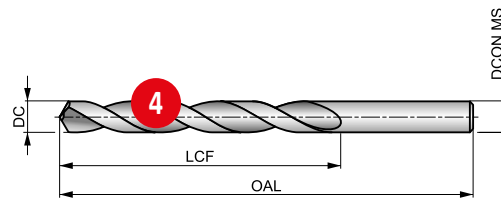

HM	DIN 338	4xD
120°	Bright	
20-35°	R	DC h7

5

Workpiece material group suitability, starting values for cutting speed (m/min) and feed Alpha Code. Tables with feed per revolution can be found starting from page XY.

P1.1	P1.2	P1.3	P2.1	P2.2	P2.3	P3.1	P3.2	P3.3	P4.1	P4.2	P4.3	K1.1	K1.2
99 S	111 S	115 S	85 S	75 S	66 S	66 S	53 S	45 S	40 S	34 S	27 S	75 T	56 T
K1.3	K2.1	K2.2	K2.3	K3.1	K3.2	K3.3	K4.1	K4.2	K4.3	K4.4	K4.5	K5.1	K5.2
42 T	68 T	55 T	44 T	60 T	46 T	37 T	55 T	42 T	31 T	26 T	22 T	63 T	47 T
K5.3	N1.1	N1.2	N1.3	N2.1	N2.2	N2.3	N3.1	N3.2	N4.1	N4.2	H1.1	H2.1	H2.2
37 T	200 V	150 V	100 V	172 V	155 V	112 V	423 V	250 V	60 X	100 V	56 S	33 S	36 S
H3.1	H3.2												
37 S	30 S												

6

Product	DC [mm]	DC [inch]	LCF [mm]	OAL [mm]	DCON MS [mm]
R1001.0	1.00	0.0394	12.0	34.0	1.00
R1001.1	1.10	0.0433	14.0	36.0	1.10
R1001.2	1.20	0.0472	16.0	38.0	1.20
R1001.3	1.30	0.0512	16.0	38.0	1.30
R1001.4	1.40	0.0551	18.0	40.0	1.40
R1001.5	1.50	0.0591	18.0	40.0	1.50
R1001.6	1.60	0.0630	20.0	43.0	1.60
R1001.7	1.70	0.0669	20.0	43.0	1.70
R1001.8	1.80	0.0709	22.0	46.0	1.80
R1001.9	1.90	0.0748	22.0	46.0	1.90
R1002.0	2.00	0.0787	24.0	49.0	2.00

7

8

Product	DC [mm]	DC [inch]	LCF [mm]	OAL [mm]	DCON MS [mm]
R1003.6	3.60	0.1417	39.0	70.0	3.60
R1003.7	3.70	0.1457	39.0	70.0	3.70
R1003.8	3.80	0.1496	43.0	75.0	3.80
R1003.9	3.90	0.1535	43.0	75.0	3.90
R1004.0	4.00	0.1575	43.0	75.0	4.00
R1004.1	4.10	0.1614	43.0	75.0	4.10
R1004.2	4.20	0.1654	43.0	75.0	4.20
R1004.3	4.30	0.1693	47.0	80.0	4.30
R1004.4	4.40	0.1732	47.0	80.0	4.40
R1004.5	4.50	0.1772	47.0	80.0	4.50
R1004.6	4.60	0.1811	47.0	80.0	4.60

Pos.	Description
1	Designation of drill
2	Product description
3	Illustrative picture
4	Schematic drawing of tool

Pos.	Description
5	Product features
6	Material group recommendations incl. speed and feed guidance
7	Product code
8	Product dimensions



SOLID CARBIDE & HSS DRILLS – ICONS OVERVIEW

General Icons

	Primary use		Possible use
--	-------------	--	--------------

Application Angle

	60° Countersink Centre Drill		Radius Countersink Centre Drill		Pre-Drill with 90° Chamfer (for tapping)
	Drill Point 118°		Spot Drill Point 90°/120°		Spot Drill Point 150°
	Drill Point 120°		Spot-weld Drill Point 180°		Spot Drill Point 90°
	Drill Point 122°		Step-drill (for fasteners) 180° Counterbore		Spot Drill Point 120°
	Drill Point 130°		Step-drill (for fasteners) 90° Counterbore		
	Drill Point 135°		Drill Point 140°		

Basic Standard Group (BSG)

	BS 328 – Drills and Reamers Standards		DIN 1899 – Micro Drill Standards		DIN 8037 – Carbide Tipped Drill Standards
	DIN 1869 / 1 – Straight Shank Extra Long Drill Standards		DIN 333A – Centre Drill Standards		DIN 8374 – Subland Drill Standards
	DIN 1869 / 2 – Straight Shank Extra Long Drill Standards		DIN 333R – Straight Shank Countersink Standards		DIN 8376 – Step Drill Standards
	DIN 1869 / 3 – Straight Shank Extra Long Drill Standards		DIN 338 – Straight Shank Drill Standards		DIN 8377 – Subland Drill Standards
	DIN 1870 (1) – Morse Taper Shank Extra Long Drill Standards		DIN 340 – Taper Length Drill Standards		DIN/ANSI Standards
	DIN 1870 (2) – Morse Taper Shank Extra Long Drill Standards		DIN 341 – Morse Taper Shank Long Drill Standards		Dormer Standards
	DIN 1897 – Stub Drill Standards		DIN 345 – Morse Taper Shank Drill Standards		NAS907 – Aerospace Drill Standards

Coating

	Aluminium Chromium Nitride (with smoothing process)		Bronze Tempered (Bronze Oxide) Surface Treatment		Titanium Aluminium Nitride (with smoothing process)
	Bright (uncoated)		Combination Bright and Steam Tempered		Titanium Aluminium Nitride Coating
	Bright and TiN (Tip Coating)		Steam Tempered (Steam Oxide) Surface Treatment		Titanium Nitride Coating



SOLID CARBIDE & HSS DRILLS – ICONS OVERVIEW

Coolant Supply Property (CSP)



Through Tool Coolant

Cutting Direction



Left Hand Rotation / Cutting



Right Hand Rotation / Cutting

Cutting Diameter Tolerance Zone Class (TCDC)

DC h8 h8 – Industry Standard Tool Tolerance Zone (based on diameter range)

DC h7 h7 – Industry Standard Tool Tolerance Zone (based on diameter range)

DC m7 m7 – Industry Standard Tool Tolerance Zone (based on diameter range)

DC h6 h6 – Industry Standard Tool Tolerance Zone (based on diameter range)

Material Code (BMC)

HM Hard Material (Solid Carbide)

HSS HM High Speed Steel (tool body) with Solid Carbide (cutting tool material)

HSS High Speed Steel Tool Material

HSS-E High Speed Cobalt Steel Tool Material

Shank

Cylindrical Shank / Straight Shank

Cylindrical Shank with Tang

Morse Taper Shank

Cylindrical Shank with Flat

DIN 6535 HA Cylindrical Shank

Reduced Cylindrical Shank

Spiral Form

Quick Spiral Flute Design

Standard Spiral Flute Design

Continuously Thinned Web Flute Design

Slow Spiral Flute Design

Quick Spiral Flute Design

VA Special Point Thinning Design

Usable Length Diameter Ratio (ULDR)

1.25xD 1.25xD Usable Tool Depth to Diameter Ratio

2.5xD 2.5xD Usable Tool Depth to Diameter Ratio

5xD 5xD Usable Tool Depth to Diameter Ratio

1.5xD 1.5xD Usable Tool Depth to Diameter Ratio

20xD 20xD Usable Tool Depth to Diameter Ratio

6xD 6xD Usable Tool Depth to Diameter Ratio

10xD 10xD Usable Tool Depth to Diameter Ratio

25xD 25xD Usable Tool Depth to Diameter Ratio

8xD 8xD Usable Tool Depth to Diameter Ratio

15xD 15xD Usable Tool Depth to Diameter Ratio

3xD 3xD Usable Tool Depth to Diameter Ratio

1xD 1xD Usable Tool Depth to Diameter Ratio

4xD 4xD Usable Tool Depth to Diameter Ratio



SOLID CARBIDE DRILLS



FORCE X

HIGH PERFORMANCE CARBIDE DRILLS

VERSATILE PRODUCTION DRILLS FOR A WIDE RANGE OF MATERIALS

FORCE X carbide drills are developed for high performance machining applications in a wide variety of work-materials such as Carbon and Alloy Steels up to 1500 MPa and Cast-Iron. FORCE X drills also perform well in Stainless Steel and Aluminium making them an ideal first choice for subcontract machining companies.

FEATURES AND BENEFITS

- CTW  – Unique Flute Construction with a continuously thinned web and rolled heel design.
- Modified 4-Facet Split Point with large secondary chisel edge angle.
- Premium micrograin carbide substrate with TiAlN coating.
- 3xD and 5xD options available in solid and coolant-feed variants.
- 8xD with coolant-feed.

COMPARED TO CONVENTIONAL DRILLS FORCE X ARE:

- **Outstandingly economical** – Able to be re-ground multiple times, this significantly increases total tool life.
- **Consistently high quality and performance** – with excellent positional accuracy and swarf control, ensuring a superior quality hole tolerance and surface finish.
- **More productive** – with high drilling speeds and prolonged tool-life.



RANGE DETAILS

3xD



R457

Coolant-feed

R458

Solid

- 3.00 – 20.00 mm
- 1/8 – 3/4 inch, N30 – N1, A – Z

5xD



R453

Coolant-feed

R454

Solid

- 3.00 – 20.00 mm
- 1/8 – 3/4 inch, N30 – N1, A – Z

8xD



R459

Coolant-feed

- 3.00 – 16.00 mm
- 1/8 – 5/8 inch



FORCE X

HIGH PERFORMANCE CARBIDE DRILLS



MACHINING EXAMPLE

			Free Machining Steel P1.3	Alloy Steel P3.3	Gray Iron K1.2
Workpiece			1.0718 (11SMnPb30)	1.6582 (34CrNiMo6)	0.6025 (GG-25)
Hardness		HB	180	325	215
Tensile strength		MPa	620	1120	260
Diameter		mm	8 (R4578.0)	8 (R4598.0)	8 (R4538.0)
Hole depth		mm	3xD (24)	8xD (64)	5xD (40)
Cutting speed	v_c	m/min	207	73	77
Feed	f	mm/rev	0.26	0.14	0.26
Coolant			Emulsion 8 % through coolant	Emulsion 8 % through coolant	Emulsion 8 % through coolant



FORCE M

HIGH PERFORMANCE CARBIDE DRILLS

HIGH VOLUME PRODUCTION DRILLS FOR STAINLESS STEEL

FORCE M carbide drills have been engineered to provide the highest performance and process reliability when drilling Stainless steels and Heat resistant super alloys. FORCE M drills are ideal for applications where it is necessary to drill a large number of holes with high and constant accuracy.

FEATURES AND BENEFITS

- CTW  – Unique Flute Construction with a continuously thinned web and rolled heel design.
- S-Shape 4-Facet Split Point with precise thin edge honing and strong outer corner design.
- Premium micrograin carbide substrate with TiAlN coating.
- 3xD and 5xD with coolant-feed.
- 8xD with coolant-feed available upon request.

COMPARED TO CONVENTIONAL DRILLS FORCE M PROVIDE:

- **Reliable performance** – with a smooth cutting action to prevent onset of work-hardening and built up edge.
- **Optimized productivity** – with excellent chip-management and a better force distribution to allow high penetration rates.
- **Exceptional tool life** – with stronger corner and cutting edges to withstand deformation wear.



RANGE DETAILS

3xD



R467

Coolant-feed

- 3.00 – 16.00 mm
- 1/8 – 5/8 inch

5xD



R463

Coolant-feed

- 3.00 – 16.00 mm
- 1/8 – 5/8 inch

8xD



R469

Coolant-feed

- Available upon request**
- 3.00 – 16.00 mm
 - 1/8 – 5/8 inch



FORCE M

HIGH PERFORMANCE CARBIDE DRILLS



MACHINING EXAMPLE

			Ferritic SST M1.2	Austenitic SST M3.2	High Strength SST M4.1
Workpiece			1.4104 (AISI 430F)	1.4401 (AISI 316)	1.4501 (Super DUPLEX)
Hardness		HB	220	200	240
Tensile strength		MPa	700	750	770
Diameter		mm	8 (R4678.0)	8 (S-R4698.0)	8 (R4638.0)
Hole depth		mm	3×D (24)	8×D (64)	5×D (40)
Cutting speed	v_c	m/min	99	74	57
Feed	f	mm/rev	0.16	0.14	0.12
Coolant			Emulsion 8 % through coolant	Emulsion 8 % through coolant	Emulsion 8% through coolant



FORCE N

HIGH PERFORMANCE CARBIDE DRILLS

HIGH PENETRATION RATE DRILLS FOR ALUMINIUM

FORCE N carbide drills are recommended for high speed drilling operations in wrought and cast aluminium alloys. The flute and cutting geometry are specifically designed to break the swarf into small manageable chips to enhance chip-
evacuation. FORCE N drills provide superior performance and tool life for mid-high volume manufacturing companies.

FEATURES AND BENEFITS

- Special web thinning with higher than standard helix angle.
- Unique geometry with convex cutting edges and 4-facet self-centering point.
- Premium micrograin carbide substrate with bright finish.
- 5xD and 8xD with coolant-feed available upon request.

COMPARED TO CONVENTIONAL DRILLS FORCE N DELIVER:

- **Superior performance** – with high drilling speeds and long tool life.
- **Economical solution** – which can be used across all types of aluminium from soft through to abrasive grades.
- **Optimized process** – designed to reduce thrust force improving hole quality and reducing exit burr which occurs when drilling soft materials.

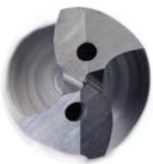

RANGE DETAILS

5xD



R445

Coolant-feed

Available upon request

- 3.00 – 16.00 mm
- 1/8 – 5/8 inch

8xD



R448

Coolant-feed

Available upon request

- 3.00 – 16.00 mm
- 1/8 – 5/8 inch

Up
to
12xD

**Longer lengths available
upon request**



FORCE N

HIGH PERFORMANCE CARBIDE DRILLS



MACHINING EXAMPLE

			Wrought Aluminium N1.2	Cast Aluminium N2.2
Workpiece			AW 2024-O (3.1355)	A242.0
Hardness		HB	50	75
Tensile strength		MPa	200	220
Diameter		mm	8 mm (R4458.0)	8 mm (S-R4488.0)
Hole depth		mm	5xD (40)	8xD (64)
Cutting speed	v_c	m/min	357	374
Feed	f	mm/rev	0.80	0.33
Coolant			Emulsion 8 % through coolant	Emulsion 8 % through coolant



Exit burr with conventional drill

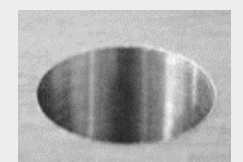

Exit burr with FORCE N drill



DORMER PRAMET

FOLLOW US



SHARE



LIKE



COMMENT



TAG



RE-TWEET







SOLID CARBIDE – NAVIGATOR TOOL MATERIALS

Carbide materials

Carbide Materials (or Hard Materials)		<p>A sintered powder metallurgy substrate, consisting of a metallic carbide composite with binder metal. The most central raw material is tungsten carbide (WC). Tungsten carbide contributes to the hardness of the material. Tantalum carbide (TaC), titanium carbide (TiC) and niobium carbide (NbC) complements WC and adjusts the properties to what is desired. These three materials are called cubic carbides. Cobalt (Co) acts as a binder and keeps the material together.</p> <p>Carbide materials are often characterised by high compression strength, high hardness and therefore high wear resistance, but also by limited flexural strength and toughness. Carbide is used in taps, reamers, milling cutters, drills and thread milling cutters.</p>
--	---	--

Surface Coatings

Bright (uncoated)		<p>Bright finish (uncoated surface) improves chip flow in soft or non-ferrous materials, plastics and composites while maintaining sharp cutting edges.</p>
Titanium Nitride coating (TiN)		<p>Titanium Nitride is a gold coloured ceramic coating applied by physical vapor deposition (PVD). High hardness combined with low friction properties ensures longer tool life and/or better cutting performance from tools which have not been coated.</p>
Titanium Aluminium Nitride coatings (TiAlN)		<p>Titanium Aluminium Nitride is a multi layer ceramic coating applied by PVD coating technology, which exhibits high toughness and oxidation stability. These properties make it ideal for higher speeds and feeds, while at the same time improving tool life. TiAlN is used in drilling, tapping, and milling applications and can be suitable for use when machining without coolant. TiAlN-Top coating is the same as TiAlN but with a post-coating process designed to smooth out imperfections, enhance chip flow and reduce built up edge.</p>



Material code (BMC)	HM	HM	HM	HM	HM	HM	HM	HM	HM	HM	HM	HM	HM
Basic standard group (BSG)	DIN 333A	DORMER	DORMER	DORMER	DORMER	DORMER	DIN 6539	DIN 338	DIN 6539	DIN 338	DIN 6537K	DIN 6537K	DIN 6537L
Usable length (ULDR)	1xD	1xD	1xD	1xD	1xD	3xD	2.5xD	4xD	2.5xD	4xD	3xD	3xD	5xD
Application angle	60°	120°	90°	150°	90°	90°	120°	120°	130°	130°	140°	140°	140°
Coating	Bright	Bright	Bright	TIAIN	TIAIN	TIAIN	Bright	Bright	TIN	TIN	TIAIN	TIAIN	TIAIN
Shank						DIN 6535HA	DIN 6535HA				DIN 6535HA	DIN 6535HA	DIN 6535HA
Spiral form		λ 20-35°	λ 20-35°	λ 20-35°	λ 20-35°	λ 20-35°	λ 20-35°	λ 20-35°	λ 20-35°	λ 20-35°	CTW	CTW	CTW
Hand (Cutting direction)	R	R	R	R	R	R	R	R	R	R	R	R	R
Cooling (CSP)													
Product Family Code	R200	R122	R123	R125	R6011	R7131	R120	R100	R520	R510	R458	R457	R454
	1.00 - 5.00	5.00 - 20.00	5.00 - 20.00	6.00 - 16.00	6.00 - 16.00	3.30 - 10.40	1.00 - 12.00	1.00 - 14.00	3.00 - 16.50	3.00 - 14.25	3.00 - 20.00	3.00 - 20.00	3.00 - 20.00
	26	27	28	29	30	31	32	34	36	38	40	44	48
P	P1	■	■	■	■	■	■	■	■	■	■	■	■
	P2	■	■	■	■	■	■	■	■	■	■	■	■
	P3	■	■	■	■	■	■	■	■	■	■	■	■
	P4	■	■	■	■	■	■	■	■	■	■	■	■
M	M1		■	■	■	■			■	■	■	■	■
	M2		■	■	■	■			■	■	■	■	■
	M3		■	■	■	■				■	■	■	■
	M4						■				■	■	■
K	K1	■	■	■	■	■	■	■	■	■	■	■	■
	K2	■	■	■	■	■	■	■	■	■	■	■	■
	K3	■	■	■	■	■	■	■	■	■	■	■	■
	K4	■	■	■	■	■	■	■	■	■	■	■	■
	K5	■	■	■	■	■	■	■	■	■	■	■	■
N	N1	■	■	■	■	■	■	■	■	■	■	■	■
	N2	■	■	■	■	■	■	■	■	■	■	■	■
	N3	■	■	■	■	■	■	■	■	■	■	■	■
	N4		■	■	■	■	■	■	■	■	■	■	■
	N5												
S	S1		■	■	■	■		■	■	■	■	■	■
	S2		■	■	■	■		■					
	S3		■	■	■	■		■					
	S4		■	■	■	■		■					
H	H1		■	■	■	■		■	■	■	■	■	■
	H2		■	■	■	■		■	■	■	■	■	■
	H3		■	■	■	■		■	■	■	■	■	■
	H4		■	■	■	■		■	■	■	■	■	■

■ Primary use ■ Possible use

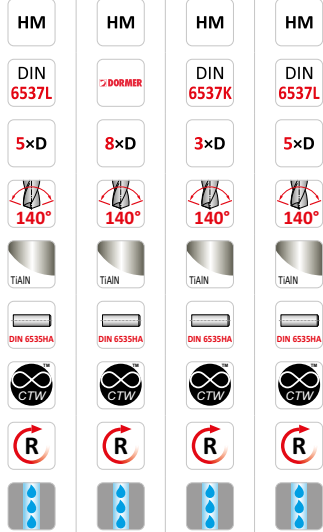

R453 R459 R467 R463

3.00 - 20.00 3.00 - 16.00 3.00 - 16.00 3.00 - 16.00

52 56 59 62

P1	■	■		
P2	■	■		
P3	■	■		
P4	■	■		
M1	☑	☑	■	■
M2	☑	☑	■	■
M3	☑	☑	■	■
M4	☑	☑	■	■
K1	■	■		
K2	■	■		
K3	■	■		
K4	■	■		
K5	■	■		
N1	■	☑		
N2	■	■		
N3	■	☑		
N4				
N5				
S1	■		■	■
S2			☑	☑
S3			☑	☑
S4			☑	☑
H1	■			
H2	☑			
H3	☑			
H4				

■ Primary use ☑ Possible use



R200

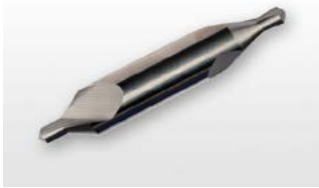

Solid Carbide Center Drill with 118° Point and 60° Countersink, Bright Finish

Recommended for starting a precise hole in the end of a shaft so it can be securely held prior to machining. Suitable to machine a number of materials and has two drilling ends to give increased productivity per tool. Includes a 118° point angle and 60° countersink. Suitable for all CNC machines.

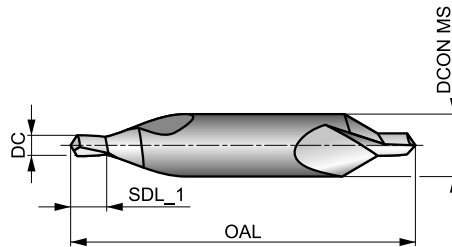

HM	DIN 333A	1xD
60°	Bright	
R		

Workpiece material group suitability, starting values for cutting speed (m/min) and feed Alpha Code. Tables with feed per revolution can be found starting from page 65.

P1.1 ■ 60 H	P1.2 ■ 67 H	P1.3 ■ 69 H	P2.1 ■ 51 H	P2.2 ■ 45 F	P2.3 ■ 40 D	P3.1 ■ 44 E	P3.2 ■ 36 E	P3.3 ■ 30 D	P4.1 ■ 26 E	P4.2 ■ 22 D	P4.3 ■ 18 C	K1.1 ■ 40 H	K1.2 ■ 30 E
K1.3 ■ 22 E	K2.1 ■ 37 D	K2.2 ■ 30 D	K2.3 ■ 24 D	K3.1 ■ 33 D	K3.2 ■ 25 D	K3.3 ■ 20 D	K4.1 ■ 30 D	K4.2 ■ 23 D	K4.3 ■ 17 D	K4.4 ■ 14 D	K4.5 ■ 12 D	K5.1 ■ 34 D	K5.2 ■ 26 D
K5.3 ■ 20 D	N1.1 ■ 120 I	N1.2 ■ 90 I	N1.3 ■ 60 H	N2.1 ■ 154 G	N2.2 ■ 138 G	N2.3 ■ 100 G	N3.1 ■ 169 G	N3.2 ■ 100 H	N3.3 ■ 50 F				

Product	DC	DC	SDL_1	OAL	DCON MS
	[mm]	[inch]			
R2001.0X3.15	1.00	0.0394	1.7 - 1.3	31.0	3.15
R2001.25X3.15	1.25	0.0492	2.0 - 1.6	31.0	3.15
R2001.6X4.0	1.60	0.0630	2.6 - 2.0	35.0	4.00
R2002.0X5.0	2.00	0.0787	3.1 - 2.5	40.0	5.00
R2002.5X6.3	2.50	0.0984	3.8 - 3.1	45.0	6.30
R2003.15X8.0	3.15	0.1240	4.6 - 3.9	50.0	8.00
R2004.0X10.0	4.00	0.1575	5.9 - 5.0	55.0	10.00
R2005.0X12.5	5.00	0.1969	7.2 - 6.3	63.0	12.50



R122



Solid Carbide Spotting Drill, 120° Point

The precision engineered point angle provides an accurate guide to help with centering of follow-up drilling of the hole. A 120° point angle helps with self-centering and reduces cutting forces when drilling a variety of materials.

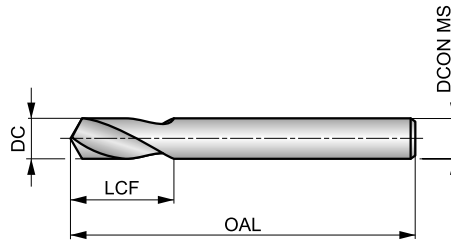

HM	DORMER	1×D
120°	Bright	
λ 20-35°	R	DC h6

Workpiece material group suitability, starting values for cutting speed (m/min) and feed Alpha Code. Tables with feed per revolution can be found starting from page 65.

P1.1 ■ 99 S	P1.2 ■ 111 S	P1.3 ■ 115 S	P2.1 ■ 85 S	P2.2 ■ 75 S	P2.3 ■ 66 S	P3.1 ■ 66 S	P3.2 ■ 53 S	P3.3 ■ 45 S	P4.1 ■ 40 S	P4.2 ■ 34 S	P4.3 ■ 27 S	M1.1 ■ 73 S	M1.2 ■ 61 S
M2.1 ■ 65 S	M2.2 ■ 53 S	M3.1 ■ 52 S	M3.2 ■ 45 S	K1.1 ■ 75 T	K1.2 ■ 56 T	K1.3 ■ 42 T	K2.1 ■ 68 T	K2.2 ■ 55 T	K2.3 ■ 44 T	K3.1 ■ 60 T	K3.2 ■ 46 T	K3.3 ■ 37 T	K4.1 ■ 55 T
K4.2 ■ 42 T	K4.3 ■ 31 T	K4.4 ■ 26 T	K4.5 ■ 22 T	K5.1 ■ 63 T	K5.2 ■ 47 T	K5.3 ■ 37 T	N1.1 ■ 200 V	N1.2 ■ 150 V	N1.3 ■ 100 V	N2.1 ■ 172 V	N2.2 ■ 155 V	N2.3 ■ 112 V	N3.1 ■ 423 V
N3.2 ■ 250 V	N3.3 ■ 125 V	N4.1 ■ 60 X	N4.2 ■ 100 V	S1.1 ■ 45 T	S1.2 ■ 35 T	S1.3 ■ 25 S	S2.1 ■ 40 S	S2.2 ■ 28 S	S3.1 ■ 30 S	S3.2 ■ 20 S	S4.1 ■ 23 S	S4.2 ■ 16 S	H1.1 ■ 56 S
H2.1 ■ 33 S	H2.2 ■ 36 S	H3.1 ■ 37 S	H3.2 ■ 30 S										

Product	DC	DC	LCF	OAL	DCON MS
	[mm]	[inch]	[mm]	[mm]	[mm]
R1225.0	5.00	0.1969	16.0	62.0	5.00
R1226.0	6.00	0.2362	17.0	66.0	6.00
R1228.0	8.00	0.3150	22.0	79.0	8.00
R12210.0	10.00	0.3937	26.0	89.0	10.00
R12212.0	12.00	0.4724	30.0	102.0	12.00
R12216.0	16.00	0.6299	34.0	115.0	16.00
R12220.0	20.00	0.7874	40.0	131.0	20.00



R123



Solid Carbide Spotting Drill, 90° Point

The precision engineered point angle provides an accurate guide to help with centering of follow-up drilling of the hole. A 90° point helps with self-centering and reduces cutting forces when drilling into a variety of materials.

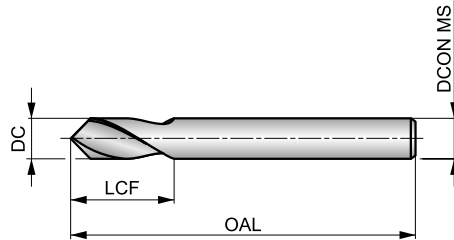

HM	DORMER	1xD
90°	Bright	
λ 20-35°	R	DC h6

Workpiece material group suitability, starting values for cutting speed (m/min) and feed Alpha Code. Tables with feed per revolution can be found starting from page 65.

P1.1 ■ 99 S	P1.2 ■ 111 S	P1.3 ■ 115 S	P2.1 ■ 85 S	P2.2 ■ 75 S	P2.3 ■ 66 S	P3.1 ■ 66 S	P3.2 ■ 53 S	P3.3 ■ 45 S	P4.1 ■ 40 S	P4.2 ■ 34 S	P4.3 ■ 27 S	M1.1 ■ 73 S	M1.2 ■ 61 S
M2.1 ■ 65 S	M2.2 ■ 53 S	M3.1 ■ 52 S	M3.2 ■ 45 S	K1.1 ■ 75 T	K1.2 ■ 56 T	K1.3 ■ 42 T	K2.1 ■ 68 T	K2.2 ■ 55 T	K2.3 ■ 44 T	K3.1 ■ 60 T	K3.2 ■ 46 T	K3.3 ■ 37 T	K4.1 ■ 55 T
K4.2 ■ 42 T	K4.3 ■ 31 T	K4.4 ■ 26 T	K4.5 ■ 22 T	K5.1 ■ 63 T	K5.2 ■ 47 T	K5.3 ■ 37 T	N1.1 ■ 200 V	N1.2 ■ 150 V	N1.3 ■ 100 V	N2.1 ■ 172 V	N2.2 ■ 155 V	N2.3 ■ 112 V	N3.1 ■ 423 V
N3.2 ■ 250 V	N3.3 ■ 125 V	N4.1 ■ 60 X	N4.2 ■ 100 V	S1.1 ■ 45 T	S1.2 ■ 35 T	S1.3 ■ 25 S	S2.1 ■ 40 S	S2.2 ■ 28 S	S3.1 ■ 30 S	S3.2 ■ 20 S	S4.1 ■ 23 S	S4.2 ■ 16 S	H1.1 ■ 56 S
H2.1 ■ 33 S	H2.2 ■ 36 S	H3.1 ■ 37 S	H3.2 ■ 30 S										

Product	DC	DC	LCF	OAL	DCON MS
	[mm]	[inch]	[mm]	[mm]	[mm]
R1235.0	5.00	0.1969	16.0	62.0	5.00
R1236.0	6.00	0.2362	17.0	66.0	6.00
R1238.0	8.00	0.3150	22.0	79.0	8.00
R12310.0	10.00	0.3937	26.0	89.0	10.00
R12312.0	12.00	0.4724	30.0	102.0	12.00
R12316.0	16.00	0.6299	34.0	115.0	16.00
R12320.0	20.00	0.7874	40.0	131.0	20.00



R125



Solid Carbide Spotting Drill, 150° Point, TiAlN Coated

The precision engineered point angle provides an accurate guide to help with centering of follow-up drilling of the hole. A 150° point helps with self-centering and reduces cutting forces when drilling into the material. TiAlN coating improves performance and extends the tool life. Suitable for drilling many materials.

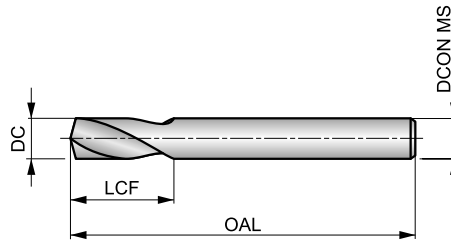
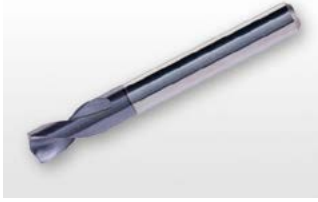

HM	DORMER	1×D
150°	TiAlN	
λ _{20-35°}	R	DC h6

Workpiece material group suitability, starting values for cutting speed (m/min) and feed Alpha Code. Tables with feed per revolution can be found starting from page 65.

P1.1 ■ 119 S	P1.2 ■ 134 S	P1.3 ■ 138 S	P2.1 ■ 102 S	P2.2 ■ 90 S	P2.3 ■ 80 S	P3.1 ■ 81 S	P3.2 ■ 65 S	P3.3 ■ 55 S	P4.1 ■ 48 S	P4.2 ■ 41 S	P4.3 ■ 34 S	M1.1 ■ 82 S	M1.2 ■ 70 S
M2.1 ■ 73 S	M2.2 ■ 60 S	M3.1 ■ 58 S	M3.2 ■ 50 S	K1.1 ■ 80 T	K1.2 ■ 59 T	K1.3 ■ 44 T	K2.1 ■ 86 T	K2.2 ■ 70 T	K2.3 ■ 56 T	K3.1 ■ 76 T	K3.2 ■ 58 T	K3.3 ■ 47 T	K4.1 ■ 71 T
K4.2 ■ 53 T	K4.3 ■ 39 T	K4.4 ■ 33 T	K4.5 ■ 28 T	K5.1 ■ 80 T	K5.2 ■ 60 T	K5.3 ■ 46 T	N1.1 ■ 200 V	N1.2 ■ 150 V	N1.3 ■ 100 V	N2.1 ■ 172 V	N2.2 ■ 155 V	N2.3 ■ 112 V	N3.1 ■ 423 V
N3.2 ■ 250 V	N3.3 ■ 125 V	N4.1 ■ 60 X	N4.2 ■ 100 V	S1.1 ■ 55 T	S1.2 ■ 45 T	S1.3 ■ 35 S	S2.1 ■ 53 S	S2.2 ■ 42 S	S3.1 ■ 40 S	S3.2 ■ 30 S	S4.1 ■ 31 S	S4.2 ■ 24 S	H1.1 ■ 56 S
H2.1 ■ 33 S	H2.2 ■ 36 S	H3.1 ■ 37 S	H3.2 ■ 30 S										

DCON MS tolerance h6.

Product	DC [mm]	LCF [mm]	OAL [mm]	DCON MS [mm]
R1255.0	5.00	16.0	62.0	5.00
R1256.0	6.00	17.0	66.0	6.00
R1258.0	8.00	22.0	79.0	8.00
R12510.0	10.00	26.0	89.0	10.00
R12512.0	12.00	30.0	102.0	12.00
R12516.0	16.00	34.0	115.0	16.00



R6011



Solid Carbide Spotting Drill, 90° Point, TiAlN Coated

The precision engineered point angle provides an accurate guide to help with centering of follow-up drilling of the hole. A 90° point helps with self-centering and reduces cutting forces when drilling into the material. TiAlN coating improves performance and extends the tool life. Suitable for drilling many materials.

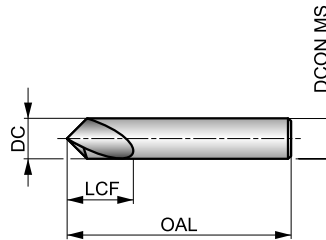

HM	DORMER	1xD
90°	TiAlN	DIN 6535HA
λ 20-35°	R	DC h6

Workpiece material group suitability, starting values for cutting speed (m/min) and feed Alpha Code. Tables with feed per revolution can be found starting from page 65.

P1.1 ■ 119 S	P1.2 ■ 134 S	P1.3 ■ 138 S	P2.1 ■ 102 S	P2.2 ■ 90 S	P2.3 ■ 80 S	P3.1 ■ 81 S	P3.2 ■ 65 S	P3.3 ■ 55 S	P4.1 ■ 48 S	P4.2 ■ 41 S	P4.3 ■ 34 S	M1.1 ■ 82 S	M1.2 ■ 70 S
M2.1 ■ 73 S	M2.2 ■ 60 S	M3.1 ■ 58 S	M3.2 ■ 50 S	K1.1 ■ 80 T	K1.2 ■ 59 T	K1.3 ■ 44 T	K2.1 ■ 86 T	K2.2 ■ 70 T	K2.3 ■ 56 T	K3.1 ■ 76 T	K3.2 ■ 58 T	K3.3 ■ 47 T	K4.1 ■ 71 T
K4.2 ■ 53 T	K4.3 ■ 39 T	K4.4 ■ 33 T	K4.5 ■ 28 T	K5.1 ■ 80 T	K5.2 ■ 60 T	K5.3 ■ 46 T	N1.1 ■ 200 V	N1.2 ■ 150 V	N1.3 ■ 100 V	N2.1 ■ 172 V	N2.2 ■ 155 V	N2.3 ■ 112 V	N3.1 ■ 423 V
N3.2 ■ 250 V	N3.3 ■ 125 V	N4.1 ■ 60 X	N4.2 ■ 100 V	S1.1 ■ 55 T	S1.2 ■ 45 T	S1.3 ■ 35 S	S2.1 ■ 53 S	S2.2 ■ 42 S	S3.1 ■ 40 S	S3.2 ■ 30 S	S4.1 ■ 31 S	S4.2 ■ 24 S	H1.1 ■ 56 S
H2.1 ■ 33 S	H2.2 ■ 36 S	H3.1 ■ 37 S	H3.2 ■ 30 S										

DCON MS tolerance h6.

Product	DC	DC	LCF	OAL	DCON MS
	[mm]	[inch]	[mm]	[mm]	[mm]
R60116.0	6.00	0.2362	16.0	50.0	6.00
R601110.0	10.00	0.3937	25.0	70.0	10.00
R601116.0	16.00	0.6299	26.0	90.0	16.00



R7131



Solid Carbide Step Drill, TiAlN Coated with Coolant Feed

Versatile, with specific Pilot diameters and lengths for achieving hole size and depth for metric threads. Drill and chamfer in one operation reduces cycle time and tooling inventory. A 140° point angle and 90° countersink. TiAlN coating improves performance and extends the tool life. Suitable for drilling many materials.

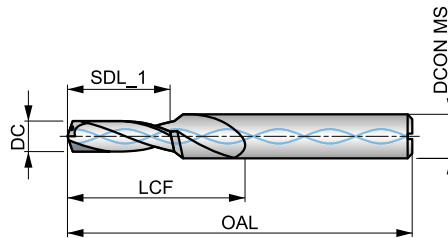

HM	DORMER	3xD
90°	TiAlN	DIN 6535HA
λ 20-35°	R	Coolant
DC m7		

Workpiece material group suitability, starting values for cutting speed (m/min) and feed Alpha Code. Tables with feed per revolution can be found starting from page 65.

P1.1 ■ 139 W	P1.2 ■ 156 W	P1.3 ■ 161 W	P2.1 ■ 119 W	P2.2 ■ 105 W	P2.3 ■ 93 V	P3.1 ■ 96 V	P3.2 ■ 77 V	P3.3 ■ 65 V	P4.1 ■ 57 V	P4.2 ■ 48 V	M1.1 ■ 62 V	M1.2 ■ 52 V	M2.1 ■ 55 V
M2.2 ■ 45 V	M3.1 ■ 47 V	M3.2 ■ 40 V	M3.3 ■ 36 U	M4.1 ■ 35 U	K1.1 ■ 90 W	K1.2 ■ 67 W	K1.3 ■ 50 W	K2.1 ■ 92 V	K2.2 ■ 75 V	K2.3 ■ 60 V	K3.1 ■ 82 V	K3.2 ■ 62 V	K3.3 ■ 50 V
K4.1 ■ 76 V	K4.2 ■ 57 V	K4.3 ■ 42 V	K4.4 ■ 36 V	K4.5 ■ 30 V	K5.1 ■ 86 V	K5.2 ■ 64 V	K5.3 ■ 50 V	N1.1 ■ 250 W	N1.2 ■ 188 W	N1.3 ■ 125 W	N2.1 ■ 308 V	N2.2 ■ 277 V	N2.3 ■ 200 V
N3.1 ■ 373 W	N3.2 ■ 220 W	N3.3 ■ 110 W											

DCON MS tolerance h6.

Product	DC [mm]	DC [inch]	SDL_1 [mm]	LCF [mm]	OAL [mm]	DCON MS [mm]	TDZ
R71313.3	3.30	0.1299	11.40	20.0	66.0	6.00	M4
R71314.2	4.20	0.1654	13.60	24.0	66.0	6.00	M5
R71315.0	5.00	0.1969	16.50	28.0	79.0	8.00	M6
R71316.8	6.80	0.2677	21.00	34.0	89.0	10.00	M8
R71318.5	8.50	0.3346	25.50	47.0	102.0	12.00	M10
R713110.2	10.20	0.4016	30.00	55.0	107.0	14.00	M12
R713110.4	10.40	0.4094	30.00	55.0	107.0	14.00	M12



R120



Solid Carbide Stub Drill, Bright Finish

Improved wear resistance for increased productivity and extended tool life. A 120°, 4-facet point helps with self-centering and reduces cutting forces. Suitable for drilling hard and abrasive materials and can be used with all CNC machine applications.

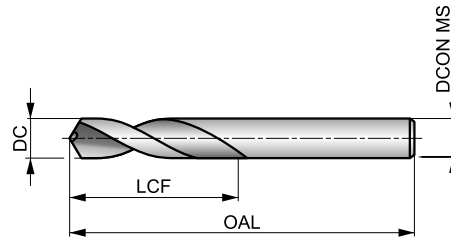

HM	DIN 6539	2.5xD
120°	Bright	
λ 20-35°	R	DC h7

Workpiece material group suitability, starting values for cutting speed (m/min) and feed Alpha Code. Tables with feed per revolution can be found starting from page 65.

P1.1 □99 S	P1.2 □111 S	P1.3 □115 S	P2.1 □85 S	P2.2 □75 S	P2.3 □66 S	P3.1 □66 S	P3.2 □53 S	P3.3 □45 S	P4.1 □40 S	P4.2 □34 S	P4.3 □27 S	K1.1 □75 U	K1.2 □56 U
K1.3 □42 U	K2.1 □68 U	K2.2 □55 U	K2.3 □44 U	K3.1 □60 U	K3.2 □46 U	K3.3 □37 U	K4.1 □55 U	K4.2 □42 U	K4.3 □31 U	K4.4 □26 U	K4.5 □22 U	K5.1 □63 U	K5.2 □47 U
K5.3 □37 U	N1.1 ■200 W	N1.2 ■150 W	N1.3 □100 W	N2.1 □172 W	N2.2 □155 W	N2.3 □112 W	N3.1 □466 W	N3.2 □275 W	N3.3 ■138 W	N4.1 ■60 U	N4.2 ■100 U	S1.1 ■45 T	S1.2 □35 T
S1.3 □25 T	S2.1 □40 T	S2.2 □28 T	S3.1 □30 T	S3.2 □20 T	S4.1 □23 T	S4.2 □16 T	H1.1 □56 S	H2.1 □33 S	H2.2 □36 S	H3.1 □37 S	H3.2 □30 S		

Product	DC	DC	LCF	OAL	DCON MS
	[mm]	[inch]			
R1201.0	1.00	0.0394	6.0	26.0	1.00
R1201.1	1.10	0.0433	7.0	28.0	1.10
R1201.2	1.20	0.0472	8.0	30.0	1.20
R1201.3	1.30	0.0512	8.0	30.0	1.30
R1201.4	1.40	0.0551	9.0	32.0	1.40
R1201.5	1.50	0.0591	9.0	32.0	1.50
R1201.6	1.60	0.0630	10.0	34.0	1.60
R1201.7	1.70	0.0669	10.0	34.0	1.70
R1201.8	1.80	0.0709	11.0	36.0	1.80
R1201.9	1.90	0.0748	11.0	36.0	1.90
R1202.0	2.00	0.0787	12.0	38.0	2.00
R1202.1	2.10	0.0827	12.0	38.0	2.10
R1202.2	2.20	0.0866	13.0	40.0	2.20
R1202.3	2.30	0.0906	13.0	40.0	2.30
R1202.4	2.40	0.0945	14.0	43.0	2.40
R1202.5	2.50	0.0984	14.0	43.0	2.50
R1202.6	2.60	0.1024	14.0	43.0	2.60
R1202.7	2.70	0.1063	16.0	46.0	2.70
R1202.8	2.80	0.1102	16.0	46.0	2.80
R1202.9	2.90	0.1142	16.0	46.0	2.90
R1203.0	3.00	0.1181	16.0	46.0	3.00
R1203.1	3.10	0.1220	18.0	49.0	3.10
R1203.2	3.20	0.1260	18.0	49.0	3.20
R1203.3	3.30	0.1299	18.0	49.0	3.30
R1203.4	3.40	0.1339	20.0	52.0	3.40
R1203.5	3.50	0.1378	20.0	52.0	3.50

Product	DC	DC	LCF	OAL	DCON MS
	[mm]	[inch]			
R1203.6	3.60	0.1417	20.0	52.0	3.60
R1203.7	3.70	0.1457	20.0	52.0	3.70
R1203.8	3.80	0.1496	22.0	55.0	3.80
R1203.9	3.90	0.1535	22.0	55.0	3.90
R1204.0	4.00	0.1575	22.0	55.0	4.00
R1204.1	4.10	0.1614	22.0	55.0	4.10
R1204.2	4.20	0.1654	22.0	55.0	4.20
R1204.3	4.30	0.1693	24.0	58.0	4.30
R1204.4	4.40	0.1732	24.0	58.0	4.40
R1204.5	4.50	0.1772	24.0	58.0	4.50
R1204.6	4.60	0.1811	24.0	58.0	4.60
R1204.7	4.70	0.1850	24.0	58.0	4.70
R1204.8	4.80	0.1890	26.0	62.0	4.80
R1204.9	4.90	0.1929	26.0	62.0	4.90
R1205.0	5.00	0.1969	26.0	62.0	5.00
R1205.1	5.10	0.2008	26.0	62.0	5.10
R1205.2	5.20	0.2047	26.0	62.0	5.20
R1205.3	5.30	0.2087	26.0	62.0	5.30
R1205.4	5.40	0.2126	28.0	66.0	5.40
R1205.5	5.50	0.2165	28.0	66.0	5.50
R1205.6	5.60	0.2205	28.0	66.0	5.60
R1205.7	5.70	0.2244	28.0	66.0	5.70
R1205.8	5.80	0.2283	28.0	66.0	5.80
R1205.9	5.90	0.2323	28.0	66.0	5.90
R1206.0	6.00	0.2362	28.0	66.0	6.00
R1206.1	6.10	0.2402	31.0	70.0	6.10



Product	DC	DC	LCF	OAL	DCON MS
	[mm]	[inch]	[mm]	[mm]	[mm]
R1206.2	6.20	0.2441	31.0	70.0	6.20
R1206.3	6.30	0.2480	31.0	70.0	6.30
R1206.4	6.40	0.2520	31.0	70.0	6.40
R1206.5	6.50	0.2559	31.0	70.0	6.50
R1206.6	6.60	0.2598	31.0	70.0	6.60
R1206.7	6.70	0.2638	31.0	70.0	6.70
R1206.8	6.80	0.2677	34.0	74.0	6.80
R1206.9	6.90	0.2717	34.0	74.0	6.90
R1207.0	7.00	0.2756	34.0	74.0	7.00
R1207.1	7.10	0.2795	34.0	74.0	7.10
R1207.2	7.20	0.2835	34.0	74.0	7.20
R1207.3	7.30	0.2874	34.0	74.0	7.30
R1207.4	7.40	0.2913	34.0	74.0	7.40
R1207.5	7.50	0.2953	34.0	74.0	7.50
R1207.6	7.60	0.2992	37.0	79.0	7.60
R1207.7	7.70	0.3031	37.0	79.0	7.70
R1207.8	7.80	0.3071	37.0	79.0	7.80
R1207.9	7.90	0.3110	37.0	79.0	7.90
R1208.0	8.00	0.3150	37.0	79.0	8.00
R1208.1	8.10	0.3189	37.0	79.0	8.10
R1208.2	8.20	0.3228	37.0	79.0	8.20
R1208.3	8.30	0.3268	37.0	79.0	8.30

Product	DC	DC	LCF	OAL	DCON MS
	[mm]	[inch]	[mm]	[mm]	[mm]
R1208.4	8.40	0.3307	37.0	79.0	8.40
R1208.5	8.50	0.3346	37.0	79.0	8.50
R1208.6	8.60	0.3386	40.0	84.0	8.60
R1208.7	8.70	0.3425	40.0	84.0	8.70
R1208.8	8.80	0.3465	40.0	84.0	8.80
R1208.9	8.90	0.3504	40.0	84.0	8.90
R1209.0	9.00	0.3543	40.0	84.0	9.00
R1209.1	9.10	0.3583	40.0	84.0	9.10
R1209.2	9.20	0.3622	40.0	84.0	9.20
R1209.3	9.30	0.3661	40.0	84.0	9.30
R1209.4	9.40	0.3701	40.0	84.0	9.40
R1209.5	9.50	0.3740	40.0	84.0	9.50
R1209.6	9.60	0.3780	43.0	89.0	9.60
R1209.7	9.70	0.3819	43.0	89.0	9.70
R1209.8	9.80	0.3858	43.0	89.0	9.80
R1209.9	9.90	0.3898	43.0	89.0	9.90
R12010.0	10.00	0.3937	43.0	89.0	10.00
R12010.2	10.20	0.4016	43.0	89.0	10.20
R12010.5	10.50	0.4134	43.0	89.0	10.50
R12011.0	11.00	0.4331	47.0	95.0	11.00
R12011.5	11.50	0.4528	47.0	95.0	11.50
R12012.0	12.00	0.4724	51.0	102.0	12.00



R100



Solid Carbide Jobber Drill, Bright Finish

Improved wear resistance for increased productivity and extended tool life. A 120°, 4-facet point helps with self-centering and reduces cutting forces. Can be used with all CNC machine applications.

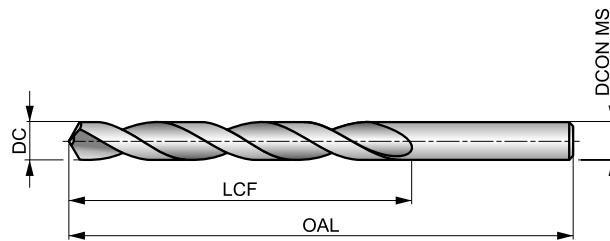

HM	DIN 338	4xD
120°	Bright	
λ 20-35°	R	DC h7

Workpiece material group suitability, starting values for cutting speed (m/min) and feed Alpha Code. Tables with feed per revolution can be found starting from page 65.

P1.1 □99 S	P1.2 □111 S	P1.3 □115 S	P2.1 □85 S	P2.2 □75 S	P2.3 □66 S	P3.1 □66 S	P3.2 □53 S	P3.3 □45 S	P4.1 □40 S	P4.2 □34 S	P4.3 □27 S	K1.1 □75 T	K1.2 □56 T
K1.3 □42 T	K2.1 □68 T	K2.2 □55 T	K2.3 □44 T	K3.1 □60 T	K3.2 □46 T	K3.3 □37 T	K4.1 □55 T	K4.2 □42 T	K4.3 □31 T	K4.4 □26 T	K4.5 □22 T	K5.1 □63 T	K5.2 □47 T
K5.3 □37 T	N1.1 □200 V	N1.2 □150 V	N1.3 □100 V	N2.1 □172 V	N2.2 □155 V	N2.3 □112 V	N3.1 ■423 V	N3.2 ■250 V	N4.1 ■60 X	N4.2 ■100 V	H1.1 □56 S	H2.1 □33 S	H2.2 □36 S
H3.1 □37 S	H3.2 □30 S												

Product	DC	DC	LCF	OAL	DCON MS
	[mm]	[inch]			
R1001.0	1.00	0.0394	12.0	34.0	1.00
R1001.1	1.10	0.0433	14.0	36.0	1.10
R1001.2	1.20	0.0472	16.0	38.0	1.20
R1001.3	1.30	0.0512	16.0	38.0	1.30
R1001.4	1.40	0.0551	18.0	40.0	1.40
R1001.5	1.50	0.0591	18.0	40.0	1.50
R1001.6	1.60	0.0630	20.0	43.0	1.60
R1001.7	1.70	0.0669	20.0	43.0	1.70
R1001.8	1.80	0.0709	22.0	46.0	1.80
R1001.9	1.90	0.0748	22.0	46.0	1.90
R1002.0	2.00	0.0787	24.0	49.0	2.00
R1002.1	2.10	0.0827	24.0	49.0	2.10
R1002.2	2.20	0.0866	27.0	53.0	2.20
R1002.3	2.30	0.0906	27.0	53.0	2.30
R1002.4	2.40	0.0945	30.0	57.0	2.40
R1002.5	2.50	0.0984	30.0	57.0	2.50
R1002.6	2.60	0.1024	30.0	57.0	2.60
R1002.7	2.70	0.1063	33.0	61.0	2.70
R1002.8	2.80	0.1102	33.0	61.0	2.80
R1002.9	2.90	0.1142	33.0	61.0	2.90
R1003.0	3.00	0.1181	33.0	61.0	3.00
R1003.1	3.10	0.1220	36.0	65.0	3.10
R1003.2	3.20	0.1260	36.0	65.0	3.20
R1003.3	3.30	0.1299	36.0	65.0	3.30
R1003.4	3.40	0.1339	39.0	70.0	3.40
R1003.5	3.50	0.1378	39.0	70.0	3.50

Product	DC	DC	LCF	OAL	DCON MS
	[mm]	[inch]			
R1003.6	3.60	0.1417	39.0	70.0	3.60
R1003.7	3.70	0.1457	39.0	70.0	3.70
R1003.8	3.80	0.1496	43.0	75.0	3.80
R1003.9	3.90	0.1535	43.0	75.0	3.90
R1004.0	4.00	0.1575	43.0	75.0	4.00
R1004.1	4.10	0.1614	43.0	75.0	4.10
R1004.2	4.20	0.1654	43.0	75.0	4.20
R1004.3	4.30	0.1693	47.0	80.0	4.30
R1004.4	4.40	0.1732	47.0	80.0	4.40
R1004.5	4.50	0.1772	47.0	80.0	4.50
R1004.6	4.60	0.1811	47.0	80.0	4.60
R1004.7	4.70	0.1850	47.0	80.0	4.70
R1004.8	4.80	0.1890	52.0	86.0	4.80
R1004.9	4.90	0.1929	52.0	86.0	4.90
R1005.0	5.00	0.1969	52.0	86.0	5.00
R1005.1	5.10	0.2008	52.0	86.0	5.10
R1005.2	5.20	0.2047	52.0	86.0	5.20
R1005.3	5.30	0.2087	52.0	86.0	5.30
R1005.4	5.40	0.2126	57.0	93.0	5.40
R1005.5	5.50	0.2165	57.0	93.0	5.50
R1005.6	5.60	0.2205	57.0	93.0	5.60
R1005.7	5.70	0.2244	57.0	93.0	5.70
R1005.8	5.80	0.2283	57.0	93.0	5.80
R1005.9	5.90	0.2323	57.0	93.0	5.90
R1006.0	6.00	0.2362	57.0	93.0	6.00
R1006.1	6.10	0.2402	63.0	101.0	6.10



Product	DC	DC	LCF	OAL	DCON MS
	[mm]	[inch]	[mm]	[mm]	[mm]
R1006.2	6.20	0.2441	63.0	101.0	6.20
R1006.3	6.30	0.2480	63.0	101.0	6.30
R1006.4	6.40	0.2520	63.0	101.0	6.40
R1006.5	6.50	0.2559	63.0	101.0	6.50
R1006.6	6.60	0.2598	63.0	101.0	6.60
R1006.7	6.70	0.2638	63.0	101.0	6.70
R1006.8	6.80	0.2677	69.0	109.0	6.80
R1006.9	6.90	0.2717	69.0	109.0	6.90
R1007.0	7.00	0.2756	69.0	109.0	7.00
R1007.1	7.10	0.2795	69.0	109.0	7.10
R1007.2	7.20	0.2835	69.0	109.0	7.20
R1007.3	7.30	0.2874	69.0	109.0	7.30
R1007.4	7.40	0.2913	69.0	109.0	7.40
R1007.5	7.50	0.2953	69.0	109.0	7.50
R1007.6	7.60	0.2992	75.0	117.0	7.60
R1007.7	7.70	0.3031	75.0	117.0	7.70
R1007.8	7.80	0.3071	75.0	117.0	7.80
R1007.9	7.90	0.3110	75.0	117.0	7.90
R1008.0	8.00	0.3150	75.0	117.0	8.00
R1008.1	8.10	0.3189	75.0	117.0	8.10
R1008.2	8.20	0.3228	75.0	117.0	8.20
R1008.3	8.30	0.3268	75.0	117.0	8.30
R1008.4	8.40	0.3307	75.0	117.0	8.40

Product	DC	DC	LCF	OAL	DCON MS
	[mm]	[inch]	[mm]	[mm]	[mm]
R1008.5	8.50	0.3346	75.0	117.0	8.50
R1008.6	8.60	0.3386	81.0	125.0	8.60
R1008.7	8.70	0.3425	81.0	125.0	8.70
R1008.8	8.80	0.3465	81.0	125.0	8.80
R1008.9	8.90	0.3504	81.0	125.0	8.90
R1009.0	9.00	0.3543	81.0	125.0	9.00
R1009.1	9.10	0.3583	81.0	125.0	9.10
R1009.2	9.20	0.3622	81.0	125.0	9.20
R1009.3	9.30	0.3661	81.0	125.0	9.30
R1009.4	9.40	0.3701	81.0	125.0	9.40
R1009.5	9.50	0.3740	81.0	125.0	9.50
R1009.6	9.60	0.3780	87.0	133.0	9.60
R1009.7	9.70	0.3819	87.0	133.0	9.70
R1009.8	9.80	0.3858	87.0	133.0	9.80
R1009.9	9.90	0.3898	87.0	133.0	9.90
R10010.0	10.00	0.3937	87.0	133.0	10.00
R10010.2	10.20	0.4016	87.0	133.0	10.20
R10010.5	10.50	0.4134	87.0	133.0	10.50
R10011.0	11.00	0.4331	94.0	142.0	11.00
R10011.5	11.50	0.4528	94.0	142.0	11.50
R10012.0	12.00	0.4724	101.0	151.0	12.00
R10013.0	13.00	0.5118	101.0	151.0	13.00
R10014.0	14.00	0.5512	108.0	160.0	14.00



R520



CDX Solid Carbide Stub Drill, TiN Coated

High performance Stub Drill, able to produce high quality and accurate holes at high speeds and feeds (H8 hole tolerance). The 130° point angle helps with self-centering and reduces cutting forces. TiN coating improves performance and extends the tool life. Suitable for all CNC machines and many materials.



CDX

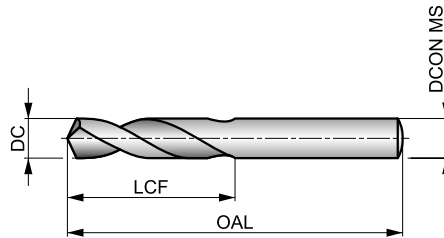

HM	DIN 6539	2.5×D
130°	TiN	
λ 20-35°	R	DC h7

Workpiece material group suitability, starting values for cutting speed (m/min) and feed Alpha Code. Tables with feed per revolution can be found starting from page 65.

P1.1 ■ 119 X	P1.2 ■ 134 X	P1.3 ■ 138 X	P2.1 ■ 102 X	P2.2 ■ 90 X	P2.3 ■ 80 X	P3.1 ■ 81 X	P3.2 ■ 65 X	P3.3 ■ 55 X	P4.1 ■ 48 X	P4.2 ■ 41 X	P4.3 ■ 34 W	M1.1 ■ 69 W	M1.2 ■ 58 W
M2.1 ■ 61 W	M2.2 ■ 50 W	K1.1 ■ 90 Y	K1.2 ■ 67 Y	K1.3 ■ 50 Y	K2.1 ■ 80 X	K2.2 ■ 65 X	K2.3 ■ 52 X	K3.1 ■ 71 X	K3.2 ■ 54 X	K3.3 ■ 44 X	K4.1 ■ 66 X	K4.2 ■ 49 X	K4.3 ■ 36 X
K4.4 ■ 31 X	K4.5 ■ 26 X	K5.1 ■ 74 X	K5.2 ■ 56 X	K5.3 ■ 43 X	N1.1 ■ 225 Z	N1.2 ■ 169 Z	N1.3 ■ 113 Z	N2.1 ■ 231 Y	N2.2 ■ 208 Y	N2.3 ■ 150 Y	N4.1 ■ 75 Z	N4.2 ■ 115 V	S1.1 ■ 60 W
S1.2 ■ 45 V	S1.3 ■ 35 U	H1.1 ■ 65 U	H2.1 ■ 38 U	H2.2 ■ 36 T	H3.1 ■ 43 U	H3.2 ■ 35 U							

DCON MS tolerance h7.

Product	DC [inch]	DC [mm]	DC [inch]	LCF [mm]	OAL [mm]	DCON MS [mm]
R5203.0	–	3.00	0.1181	16.0	46.0	3.00
R5203.1	–	3.10	0.1220	18.0	49.0	3.10
R5201/8	1/8	3.18	0.1252	18.0	49.0	3.18
R5203.2	–	3.20	0.1260	18.0	49.0	3.20
R5203.3	–	3.30	0.1299	18.0	49.0	3.30
R5203.4	–	3.40	0.1339	20.0	52.0	3.40
R5203.5	–	3.50	0.1378	20.0	52.0	3.50
R5203.6	–	3.60	0.1417	20.0	52.0	3.60
R5203.7	–	3.70	0.1457	20.0	52.0	3.70
R5203.8	–	3.80	0.1496	22.0	55.0	3.80
R5203.9	–	3.90	0.1535	22.0	55.0	3.90
R5204.0	–	4.00	0.1575	22.0	55.0	4.00
R5204.1	–	4.10	0.1614	22.0	55.0	4.10
R5204.2	–	4.20	0.1654	22.0	55.0	4.20
R5204.3	–	4.30	0.1693	24.0	58.0	4.30
R5204.4	–	4.40	0.1732	24.0	58.0	4.40
R5204.5	–	4.50	0.1772	24.0	58.0	4.50
R5204.6	–	4.60	0.1811	24.0	58.0	4.60
R5204.7	–	4.70	0.1850	24.0	58.0	4.70
R5204.8	–	4.80	0.1890	26.0	62.0	4.80
R5204.9	–	4.90	0.1929	26.0	62.0	4.90
R5205.0	–	5.00	0.1969	26.0	62.0	5.00
R5205.1	–	5.10	0.2008	26.0	62.0	5.10
R5205.2	–	5.20	0.2047	26.0	62.0	5.20
R5205.3	–	5.30	0.2087	26.0	62.0	5.30

Product	DC [inch]	DC [mm]	DC [inch]	LCF [mm]	OAL [mm]	DCON MS [mm]
R5205.4	–	5.40	0.2126	28.0	66.0	5.40
R5205.5	–	5.50	0.2165	28.0	66.0	5.50
R5205.6	–	5.60	0.2205	28.0	66.0	5.60
R5205.7	–	5.70	0.2244	28.0	66.0	5.70
R5205.8	–	5.80	0.2283	28.0	66.0	5.80
R5205.9	–	5.90	0.2323	28.0	66.0	5.90
R5206.0	–	6.00	0.2362	28.0	66.0	6.00
R5206.1	–	6.10	0.2402	31.0	70.0	6.10
R5206.2	–	6.20	0.2441	31.0	70.0	6.20
R5206.3	–	6.30	0.2480	31.0	70.0	6.30
R5201/4	1/4	6.35	0.2500	31.0	70.0	6.35
R5206.4	–	6.40	0.2520	31.0	70.0	6.40
R5206.5	–	6.50	0.2559	31.0	70.0	6.50
R5206.6	–	6.60	0.2598	31.0	70.0	6.60
R5206.7	–	6.70	0.2638	31.0	70.0	6.70
R5206.8	–	6.80	0.2677	34.0	74.0	6.80
R5206.9	–	6.90	0.2717	34.0	74.0	6.90
R5207.0	–	7.00	0.2756	34.0	74.0	7.00
R5207.1	–	7.10	0.2795	34.0	74.0	7.10
R5207.2	–	7.20	0.2835	34.0	74.0	7.20
R5207.3	–	7.30	0.2874	34.0	74.0	7.30
R5207.4	–	7.40	0.2913	34.0	74.0	7.40
R5207.5	–	7.50	0.2953	34.0	74.0	7.50
R5207.6	–	7.60	0.2992	37.0	79.0	7.60
R5207.7	–	7.70	0.3031	37.0	79.0	7.70



Product	DC	DC	DC	LCF	OAL	DCON MS
	[inch]	[mm]	[inch]	[mm]	[mm]	[mm]
R5207.8	–	7.80	0.3071	37.0	79.0	7.80
R5207.9	–	7.90	0.3110	37.0	79.0	7.90
R5205/16	5/16	7.94	0.3126	37.0	79.0	7.94
R5208.0	–	8.00	0.3150	37.0	79.0	8.00
R5208.1	–	8.10	0.3189	37.0	79.0	8.10
R5208.2	–	8.20	0.3228	37.0	79.0	8.20
R5208.3	–	8.30	0.3268	37.0	79.0	8.30
R5208.4	–	8.40	0.3307	37.0	79.0	8.40
R5208.5	–	8.50	0.3346	37.0	79.0	8.50
R5208.6	–	8.60	0.3386	40.0	84.0	8.60
R5208.7	–	8.70	0.3425	40.0	84.0	8.70
R5208.8	–	8.80	0.3465	40.0	84.0	8.80
R5208.9	–	8.90	0.3504	40.0	84.0	8.90
R5209.0	–	9.00	0.3543	40.0	84.0	9.00
R5209.1	–	9.10	0.3583	40.0	84.0	9.10
R5209.2	–	9.20	0.3622	40.0	84.0	9.20
R5209.3	–	9.30	0.3661	40.0	84.0	9.30
R5209.4	–	9.40	0.3701	40.0	84.0	9.40
R5209.5	–	9.50	0.3740	40.0	84.0	9.50
R5203/8	3/8	9.52	0.3748	43.0	89.0	9.52
R5209.6	–	9.60	0.3780	43.0	89.0	9.60
R5209.7	–	9.70	0.3819	43.0	89.0	9.70
R5209.8	–	9.80	0.3858	43.0	89.0	9.80
R5209.9	–	9.90	0.3898	43.0	89.0	9.90

Product	DC	DC	DC	LCF	OAL	DCON MS
	[inch]	[mm]	[inch]	[mm]	[mm]	[mm]
R52010.0	–	10.00	0.3937	43.0	89.0	10.00
R52010.1	–	10.10	0.3976	43.0	89.0	10.10
R52010.2	–	10.20	0.4016	43.0	89.0	10.20
R52010.3	–	10.30	0.4055	43.0	89.0	10.30
R52010.4	–	10.40	0.4094	43.0	89.0	10.40
R52010.5	–	10.50	0.4134	43.0	89.0	10.50
R52011.0	–	11.00	0.4331	47.0	95.0	11.00
R5207/16	7/16	11.11	0.4374	47.0	95.0	11.11
R52011.2	–	11.20	0.4409	47.0	95.0	11.20
R52011.5	–	11.50	0.4528	47.0	95.0	11.50
R52012.0	–	12.00	0.4724	51.0	102.0	12.00
R52012.5	–	12.50	0.4921	51.0	102.0	12.50
R5201/2	1/2	12.70	0.5000	51.0	102.0	12.70
R52013.0	–	13.00	0.5118	51.0	102.0	13.00
R52013.5	–	13.50	0.5315	54.0	107.0	13.50
R52014.0	–	14.00	0.5512	54.0	107.0	14.00
R52014.2	–	14.20	0.5591	56.0	111.0	14.20
R52014.25	–	14.25	0.5610	56.0	111.0	14.25
R52014.5	–	14.50	0.5709	56.0	111.0	14.50
R52015.0	–	15.00	0.5906	56.0	111.0	15.00
R52015.1	–	15.10	0.5945	58.0	115.0	15.10
R5205/8	5/8	15.88	0.6252	58.0	115.0	15.88
R52016.0	–	16.00	0.6299	58.0	115.0	16.00
R52016.5	–	16.50	0.6496	60.0	119.0	16.50



R510



CDX Solid Carbide Jobber Drill, TiN Coated

High performance drill, able to produce high quality and accurate holes at high speeds and feeds (H8 hole tolerance). The 130° point helps with self-centering and reduces cutting forces. TiN coating improves performance and extends the life of the tool. Suitable for all CNC machines and many materials.



CDX

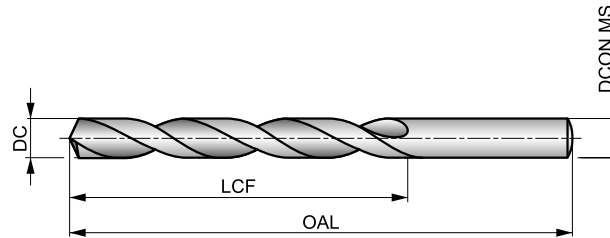

HM	DIN 338	4xD
130°	TiN	
λ 20-35°	R	DC h7

Workpiece material group suitability, starting values for cutting speed (m/min) and feed Alpha Code. Tables with feed per revolution can be found starting from page 65.

P1.1 ■ 119 W	P1.2 ■ 134 W	P1.3 ■ 138 W	P2.1 ■ 102 W	P2.2 ■ 90 W	P2.3 ■ 80 V	P3.1 ■ 81 W	P3.2 ■ 65 W	P3.3 ■ 55 V	P4.1 ■ 48 W	P4.2 ■ 41 V	P4.3 ■ 34 V	M1.1 ■ 69 V	M1.2 ■ 58 V
M2.1 ■ 61 V	M2.2 ■ 50 V	K1.1 ■ 90 X	K1.2 ■ 67 X	K1.3 ■ 50 X	K2.1 ■ 80 W	K2.2 ■ 65 W	K2.3 ■ 52 W	K3.1 ■ 71 W	K3.2 ■ 54 W	K3.3 ■ 44 W	K4.1 ■ 66 W	K4.2 ■ 49 W	K4.3 ■ 36 W
K4.4 ■ 31 W	K4.5 ■ 26 W	K5.1 ■ 74 W	K5.2 ■ 56 W	K5.3 ■ 43 W	N1.1 ■ 225 Y	N1.2 ■ 169 Y	N1.3 ■ 113 Y	N2.1 ■ 231 X	N2.2 ■ 208 X	N2.3 ■ 150 X	N4.1 ■ 75 X	N4.2 ■ 115 V	S1.1 ■ 45 V
H1.1 ■ 65 T	H2.1 ■ 38 T	H2.2 ■ 36 S	H3.1 ■ 43 T	H3.2 ■ 35 T									

DCON MS tolerance h7.

Product	DC [inch]	DC [mm]	DC [inch]	LCF [mm]	OAL [mm]	DCON MS [mm]
R5103.0	–	3.00	0.1181	33.0	61.0	3.00
R5101/8	1/8	3.18	0.1252	36.0	65.0	3.18
R5103.2	–	3.20	0.1260	36.0	65.0	3.20
R5103.3	–	3.30	0.1299	36.0	65.0	3.30
R5103.4	–	3.40	0.1339	39.0	70.0	3.40
R5103.5	–	3.50	0.1378	39.0	70.0	3.50
R5103.7	–	3.70	0.1457	39.0	70.0	3.70
R5103.9	–	3.90	0.1535	43.0	75.0	3.90
R5104.0	–	4.00	0.1575	43.0	75.0	4.00
R5104.1	–	4.10	0.1614	43.0	75.0	4.10
R5104.2	–	4.20	0.1654	43.0	75.0	4.20
R5104.3	–	4.30	0.1693	47.0	80.0	4.30
R5104.5	–	4.50	0.1772	47.0	80.0	4.50
R5104.6	–	4.60	0.1811	47.0	80.0	4.60
R5104.7	–	4.70	0.1850	47.0	80.0	4.70
R5103/16	3/16	4.76	0.1874	52.0	86.0	4.76
R5104.9	–	4.90	0.1929	52.0	86.0	4.90
R5105.0	–	5.00	0.1969	52.0	86.0	5.00
R5105.1	–	5.10	0.2008	52.0	86.0	5.10
R5105.5	–	5.50	0.2165	57.0	93.0	5.50
R5105.6	–	5.60	0.2205	57.0	93.0	5.60
R5105.7	–	5.70	0.2244	57.0	93.0	5.70
R5106.0	–	6.00	0.2362	57.0	93.0	6.00
R5101/4	1/4	6.35	0.2500	63.0	101.0	6.35
R5106.5	–	6.50	0.2559	63.0	101.0	6.50

Product	DC [inch]	DC [mm]	DC [inch]	LCF [mm]	OAL [mm]	DCON MS [mm]
R5106.6	–	6.60	0.2598	63.0	101.0	6.60
R5106.8	–	6.80	0.2677	69.0	109.0	6.80
R5106.9	–	6.90	0.2717	69.0	109.0	6.90
R5107.0	–	7.00	0.2756	69.0	109.0	7.00
R5107.3	–	7.30	0.2874	69.0	109.0	7.30
R5107.4	–	7.40	0.2913	69.0	109.0	7.40
R5107.5	–	7.50	0.2953	69.0	109.0	7.50
R5107.8	–	7.80	0.3071	75.0	117.0	7.80
R5107.9	–	7.90	0.3110	75.0	117.0	7.90
R5105/16	5/16	7.94	0.3126	75.0	117.0	7.94
R5108.0	–	8.00	0.3150	75.0	117.0	8.00
R5108.5	–	8.50	0.3346	75.0	117.0	8.50
R5108.7	–	8.70	0.3425	81.0	125.0	8.70
R5108.8	–	8.80	0.3465	81.0	125.0	8.80
R5109.0	–	9.00	0.3543	81.0	125.0	9.00
R5109.2	–	9.20	0.3622	81.0	125.0	9.20
R5109.3	–	9.30	0.3661	81.0	125.0	9.30
R5109.4	–	9.40	0.3701	81.0	125.0	9.40
R5109.5	–	9.50	0.3740	81.0	125.0	9.50
R5103/8	3/8	9.52	0.3748	87.0	133.0	9.52
R5109.9	–	9.90	0.3898	87.0	133.0	9.90
R51010.0	–	10.00	0.3937	87.0	133.0	10.00
R51010.2	–	10.20	0.4016	87.0	133.0	10.20
R51010.3	–	10.30	0.4055	87.0	133.0	10.30
R51010.4	–	10.40	0.4094	87.0	133.0	10.40



Product	DC	DC	DC	LCF	OAL	DCON MS
	[inch]	[mm]	[inch]	[mm]	[mm]	[mm]
R51010.5	–	10.50	0.4134	87.0	133.0	10.50
R51010.8	–	10.80	0.4252	94.0	142.0	10.80
R51011.0	–	11.00	0.4331	94.0	142.0	11.00
R5107/16	7/16	11.11	0.4374	94.0	142.0	11.11
R51011.2	–	11.20	0.4409	94.0	142.0	11.20
R51011.5	–	11.50	0.4528	94.0	142.0	11.50

Product	DC	DC	DC	LCF	OAL	DCON MS
	[inch]	[mm]	[inch]	[mm]	[mm]	[mm]
R51012.0	–	12.00	0.4724	101.0	151.0	12.00
R5101/2	1/2	12.70	0.5000	101.0	151.0	12.70
R51013.0	–	13.00	0.5118	101.0	151.0	13.00
R51014.0	–	14.00	0.5512	108.0	160.0	14.00
R51014.25	–	14.25	0.5610	114.0	169.0	14.25



R458



FORCE X Solid Carbide 3XD Drill, TiAlN Coated

High performance drill, able to produce high quality and accurate holes at high speeds and feeds (H9 hole tolerance). Self centering 140°, 4-facet split point and CTW flute construction for enhanced penetration rates. TiAlN coating increases surface hardness and improves tool life.

FORCE X

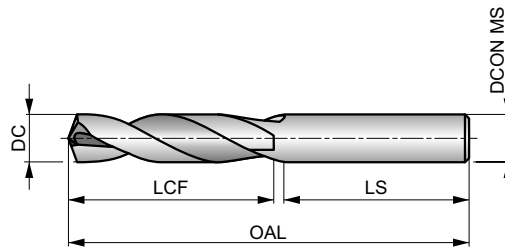

HM	DIN 6537K	3xD
140°	TiAlN	DIN 6535HA
CTW	DC m7	

Workpiece material group suitability, starting values for cutting speed (m/min) and feed Alpha Code. Tables with feed per revolution can be found starting from page 65.

P1.1 ■ 143 W	P1.2 ■ 160 W	P1.3 ■ 166 W	P2.1 ■ 122 W	P2.2 ■ 108 W	P2.3 ■ 95 V	P3.1 ■ 106 V	P3.2 ■ 86 V	P3.3 ■ 72 V	P4.1 ■ 63 V	P4.2 ■ 54 V	P4.3 ■ 44 U	M1.1 ■ 60 U	M1.2 ■ 51 U
M2.1 ■ 54 U	M2.2 ■ 44 U	M2.3 ■ 37 T	M3.1 ■ 33 T	M3.2 ■ 28 T	M3.3 ■ 26 T	M4.1 ■ 24 T	M4.2 ■ 21 T	K1.1 ■ 88 W	K1.2 ■ 65 W	K1.3 ■ 49 W	K2.1 ■ 78 V	K2.2 ■ 64 V	K2.3 ■ 51 V
K3.1 ■ 70 V	K3.2 ■ 54 V	K3.3 ■ 43 V	K4.1 ■ 65 V	K4.2 ■ 49 V	K4.3 ■ 36 V	K4.4 ■ 30 V	K4.5 ■ 26 V	K5.1 ■ 73 V	K5.2 ■ 55 V	K5.3 ■ 42 V	N1.1 ■ 200 W	N1.2 ■ 150 W	N1.3 ■ 100 W
N2.1 ■ 246 V	N2.2 ■ 222 V	N2.3 ■ 160 V	N3.1 ■ 298 V	N3.2 ■ 176 V	N3.3 ■ 88 V	S1.1 ■ 44 U	S1.2 ■ 36 U	S1.3 ■ 32 T	H1.1 ■ 45 U	H2.1 ■ 26 U	H2.2 ■ 24 U	H3.1 ■ 30 U	H3.2 ■ 24 U

DCON MS tolerance h6.

Product	DC	DC	DC	LCF	OAL	LS	DCON MS
	[inch]	[mm]	[inch]	[mm]	[mm]	[mm]	[mm]
R4583.0	–	3.00	0.1181	20.0	62.0	36.0	6.00
R4583.1	–	3.10	0.1220	20.0	62.0	36.0	6.00
R4581/8	1/8	3.18	0.1250	20.0	62.0	36.0	6.00
R4583.2	–	3.20	0.1260	20.0	62.0	36.0	6.00
R458N30	N30	3.26	0.1283	20.0	62.0	36.0	6.00
R4583.3	–	3.30	0.1299	20.0	62.0	36.0	6.00
R4583.4	–	3.40	0.1339	20.0	62.0	36.0	6.00
R458N29	N29	3.45	0.1360	20.0	62.0	36.0	6.00
R4583.5	–	3.50	0.1378	20.0	62.0	36.0	6.00
R458N28	N28	3.57	0.1406	20.0	62.0	36.0	6.00
R4589/64	9/64	3.57	0.1406	20.0	62.0	36.0	6.00
R4583.6	–	3.60	0.1417	20.0	62.0	36.0	6.00
R458N27	N27	3.66	0.1441	20.0	62.0	36.0	6.00
R4583.7	–	3.70	0.1457	20.0	62.0	36.0	6.00
R4583.73	–	3.73	0.1469	24.0	66.0	36.0	6.00
R458N26	N26	3.73	0.1469	24.0	66.0	36.0	6.00
R458N25	N25	3.80	0.1496	24.0	66.0	36.0	6.00
R4583.8	–	3.80	0.1496	24.0	66.0	36.0	6.00
R458N24	N24	3.86	0.1520	24.0	66.0	36.0	6.00
R4583.9	–	3.90	0.1535	24.0	66.0	36.0	6.00
R458N23	N23	3.91	0.1539	24.0	66.0	36.0	6.00
R4585/32	5/32	3.97	0.1563	24.0	66.0	36.0	6.00
R458N22	N22	3.99	0.1571	24.0	66.0	36.0	6.00
R4584.0	–	4.00	0.1575	24.0	66.0	36.0	6.00
R458N21	N21	4.04	0.1591	24.0	66.0	36.0	6.00



Product	DC	DC	DC	LCF	OAL	LS	DCON MS
	[inch]	[mm]	[inch]	[mm]	[mm]	[mm]	[mm]
R458N20	N20	4.09	0.1610	24.0	66.0	36.0	6.00
R4584.1	–	4.10	0.1614	24.0	66.0	36.0	6.00
R4584.2	–	4.20	0.1654	24.0	66.0	36.0	6.00
R458N19	N19	4.22	0.1661	24.0	66.0	36.0	6.00
R4584.3	–	4.30	0.1693	24.0	66.0	36.0	6.00
R458N18	N18	4.31	0.1697	24.0	66.0	36.0	6.00
R45811/64	11/64	4.37	0.1719	24.0	66.0	36.0	6.00
R458N17	N17	4.39	0.1728	24.0	66.0	36.0	6.00
R4584.4	–	4.40	0.1732	24.0	66.0	36.0	6.00
R4584.5	–	4.50	0.1772	24.0	66.0	36.0	6.00
R458N16	N16	4.50	0.1772	24.0	66.0	36.0	6.00
R458N15	N15	4.57	0.1799	24.0	66.0	36.0	6.00
R4584.6	–	4.60	0.1811	24.0	66.0	36.0	6.00
R458N14	N14	4.62	0.1819	24.0	66.0	36.0	6.00
R458N13	N13	4.70	0.1850	24.0	66.0	36.0	6.00
R4584.7	–	4.70	0.1850	24.0	66.0	36.0	6.00
R4583/16	3/16	4.76	0.1875	28.0	66.0	36.0	6.00
R4584.8	–	4.80	0.1890	28.0	66.0	36.0	6.00
R458N12	N12	4.80	0.1890	28.0	66.0	36.0	6.00
R458N11	N11	4.85	0.1909	28.0	66.0	36.0	6.00
R4584.9	–	4.90	0.1929	28.0	66.0	36.0	6.00
R458N10	N10	4.92	0.1937	28.0	66.0	36.0	6.00
R458N9	N9	4.98	0.1961	28.0	66.0	36.0	6.00
R4585.0	–	5.00	0.1969	28.0	66.0	36.0	6.00
R458N8	N8	5.06	0.1992	28.0	66.0	36.0	6.00
R4585.1	–	5.10	0.2008	28.0	66.0	36.0	6.00
R458N7	N7	5.11	0.2010	28.0	66.0	36.0	6.00
R45813/64	13/64	5.16	0.2031	28.0	66.0	36.0	6.00
R458N6	N6	5.18	0.2039	28.0	66.0	36.0	6.00
R4585.2	–	5.20	0.2047	28.0	66.0	36.0	6.00
R458N5	N5	5.22	0.2055	28.0	66.0	36.0	6.00
R4585.3	–	5.30	0.2087	28.0	66.0	36.0	6.00
R458N4	N4	5.31	0.2091	28.0	66.0	36.0	6.00
R4585.4	–	5.40	0.2126	28.0	66.0	36.0	6.00
R458N3	N3	5.41	0.2130	28.0	66.0	36.0	6.00
R4585.5	–	5.50	0.2165	28.0	66.0	36.0	6.00
R4587/32	7/32	5.56	0.2188	28.0	66.0	36.0	6.00
R4585.6	–	5.60	0.2205	28.0	66.0	36.0	6.00
R458N2	N2	5.61	0.2209	28.0	66.0	36.0	6.00
R4585.7	–	5.70	0.2244	28.0	66.0	36.0	6.00
R458N1	N1	5.79	0.2280	28.0	66.0	36.0	6.00
R4585.8	–	5.80	0.2283	28.0	66.0	36.0	6.00
R4585.9	–	5.90	0.2323	28.0	66.0	36.0	6.00
R458A	A	5.94	0.2339	28.0	66.0	36.0	6.00
R45815/64	15/64	5.95	0.2344	28.0	66.0	36.0	6.00
R4586.0	–	6.00	0.2362	28.0	66.0	36.0	6.00
R458B	B	6.05	0.2380	34.0	79.0	36.0	8.00
R4586.1	–	6.10	0.2402	34.0	79.0	36.0	8.00
R458C	C	6.15	0.2421	34.0	79.0	36.0	8.00
R4586.2	–	6.20	0.2441	34.0	79.0	36.0	8.00
R458D	D	6.25	0.2461	34.0	79.0	36.0	8.00
R4586.3	–	6.30	0.2480	34.0	79.0	36.0	8.00
R4581/4	1/4	6.35	0.2500	34.0	79.0	36.0	8.00
R458E	E	6.35	0.2500	34.0	79.0	36.0	8.00
R4586.4	–	6.40	0.2520	34.0	79.0	36.0	8.00
R4586.5	–	6.50	0.2559	34.0	79.0	36.0	8.00
R458F	F	6.53	0.2571	34.0	79.0	36.0	8.00
R4586.6	–	6.60	0.2598	34.0	79.0	36.0	8.00
R458G	G	6.63	0.2610	34.0	79.0	36.0	8.00
R4586.7	–	6.70	0.2638	34.0	79.0	36.0	8.00
R45817/64	17/64	6.75	0.2656	34.0	79.0	36.0	8.00
R458H	H	6.76	0.2661	34.0	79.0	36.0	8.00
R4586.8	–	6.80	0.2677	34.0	79.0	36.0	8.00
R4586.9	–	6.90	0.2717	34.0	79.0	36.0	8.00
R458I	I	6.91	0.2720	34.0	79.0	36.0	8.00



Product	DC	DC	DC	LCF	OAL	LS	DCON MS
	[inch]	[mm]	[inch]	[mm]	[mm]	[mm]	[mm]
R4587.0	–	7.00	0.2756	34.0	79.0	36.0	8.00
R458J	J	7.04	0.2772	34.0	79.0	36.0	8.00
R4587.1	–	7.10	0.2795	41.0	79.0	36.0	8.00
R458K	K	7.14	0.2811	41.0	79.0	36.0	8.00
R4589/32	9/32	7.14	0.2813	41.0	79.0	36.0	8.00
R4587.2	–	7.20	0.2835	41.0	79.0	36.0	8.00
R4587.3	–	7.30	0.2874	41.0	79.0	36.0	8.00
R458L	L	7.37	0.2902	41.0	79.0	36.0	8.00
R4587.4	–	7.40	0.2913	41.0	79.0	36.0	8.00
R458M	M	7.49	0.2949	41.0	79.0	36.0	8.00
R4587.5	–	7.50	0.2953	41.0	79.0	36.0	8.00
R45819/64	19/64	7.54	0.2969	41.0	79.0	36.0	8.00
R4587.6	–	7.60	0.2992	41.0	79.0	36.0	8.00
R458N	N	7.67	0.3020	41.0	79.0	36.0	8.00
R4587.7	–	7.70	0.3031	41.0	79.0	36.0	8.00
R4587.8	–	7.80	0.3071	41.0	79.0	36.0	8.00
R4587.9	–	7.90	0.3110	41.0	79.0	36.0	8.00
R4585/16	5/16	7.94	0.3125	41.0	79.0	36.0	8.00
R4588.0	–	8.00	0.3150	41.0	79.0	36.0	8.00
R458O	O	8.03	0.3161	47.0	89.0	40.0	10.00
R4588.1	–	8.10	0.3189	47.0	89.0	40.0	10.00
R4588.2	–	8.20	0.3228	47.0	89.0	40.0	10.00
R458P	P	8.20	0.3228	47.0	89.0	40.0	10.00
R4588.3	–	8.30	0.3268	47.0	89.0	40.0	10.00
R45821/64	21/64	8.33	0.3281	47.0	89.0	40.0	10.00
R4588.4	–	8.40	0.3307	47.0	89.0	40.0	10.00
R458Q	Q	8.43	0.3319	47.0	89.0	40.0	10.00
R4588.5	–	8.50	0.3346	47.0	89.0	40.0	10.00
R4588.6	–	8.60	0.3386	47.0	89.0	40.0	10.00
R458R	R	8.61	0.3390	47.0	89.0	40.0	10.00
R4588.7	–	8.70	0.3425	47.0	89.0	40.0	10.00
R45811/32	11/32	8.73	0.3438	47.0	89.0	40.0	10.00
R4588.8	–	8.80	0.3465	47.0	89.0	40.0	10.00
R458S	S	8.84	0.3480	47.0	89.0	40.0	10.00
R4588.9	–	8.90	0.3504	47.0	89.0	40.0	10.00
R4589.0	–	9.00	0.3543	47.0	89.0	40.0	10.00
R458T	T	9.09	0.3579	47.0	89.0	40.0	10.00
R4589.1	–	9.10	0.3583	47.0	89.0	40.0	10.00
R45823/64	23/64	9.13	0.3594	47.0	89.0	40.0	10.00
R4589.2	–	9.20	0.3622	47.0	89.0	40.0	10.00
R4589.3	–	9.30	0.3661	47.0	89.0	40.0	10.00
R458U	U	9.35	0.3681	47.0	89.0	40.0	10.00
R4589.4	–	9.40	0.3701	47.0	89.0	40.0	10.00
R4589.5	–	9.50	0.3740	47.0	89.0	40.0	10.00
R4583/8	3/8	9.53	0.3750	47.0	89.0	40.0	10.00
R458V	V	9.58	0.3772	47.0	89.0	40.0	10.00
R4589.6	–	9.60	0.3780	47.0	89.0	40.0	10.00
R4589.7	–	9.70	0.3819	47.0	89.0	40.0	10.00
R4589.8	–	9.80	0.3858	47.0	89.0	40.0	10.00
R458W	W	9.80	0.3858	47.0	89.0	40.0	10.00
R4589.9	–	9.90	0.3898	47.0	89.0	40.0	10.00
R45825/64	25/64	9.92	0.3906	47.0	89.0	40.0	10.00
R45810.0	–	10.00	0.3937	47.0	89.0	40.0	10.00
R458X	X	10.08	0.3969	55.0	102.0	45.0	12.00
R45810.1	–	10.10	0.3976	55.0	102.0	45.0	12.00
R45810.2	–	10.20	0.4016	55.0	102.0	45.0	12.00
R458Y	Y	10.26	0.4039	55.0	102.0	45.0	12.00
R45810.3	–	10.30	0.4055	55.0	102.0	45.0	12.00
R45813/32	13/32	10.32	0.4063	55.0	102.0	45.0	12.00
R45810.4	–	10.40	0.4094	55.0	102.0	45.0	12.00
R458Z	Z	10.49	0.4130	55.0	102.0	45.0	12.00
R45810.5	–	10.50	0.4134	55.0	102.0	45.0	12.00
R45810.6	–	10.60	0.4173	55.0	102.0	45.0	12.00
R45810.7	–	10.70	0.4213	55.0	102.0	45.0	12.00
R45827/64	27/64	10.72	0.4219	55.0	102.0	45.0	12.00



Product	DC	DC	DC	LCF	OAL	LS	DCON MS
	[inch]	[mm]	[inch]	[mm]	[mm]	[mm]	[mm]
R45810.8	–	10.80	0.4252	55.0	102.0	45.0	12.00
R45810.9	–	10.90	0.4291	55.0	102.0	45.0	12.00
R45811.0	–	11.00	0.4331	55.0	102.0	45.0	12.00
R45811.1	–	11.10	0.4370	55.0	102.0	45.0	12.00
R4587/16	7/16	11.11	0.4375	55.0	102.0	45.0	12.00
R45811.2	–	11.20	0.4409	55.0	102.0	45.0	12.00
R45811.3	–	11.30	0.4449	55.0	102.0	45.0	12.00
R45811.4	–	11.40	0.4488	55.0	102.0	45.0	12.00
R45811.5	–	11.50	0.4528	55.0	102.0	45.0	12.00
R45829/64	29/64	11.51	0.4531	55.0	102.0	45.0	12.00
R45811.6	–	11.60	0.4567	55.0	102.0	45.0	12.00
R45811.7	–	11.70	0.4606	55.0	102.0	45.0	12.00
R45811.8	–	11.80	0.4646	55.0	102.0	45.0	12.00
R45811.9	–	11.90	0.4685	55.0	102.0	45.0	12.00
R45815/32	15/32	11.91	0.4688	55.0	102.0	45.0	12.00
R45812.0	–	12.00	0.4724	55.0	102.0	45.0	12.00
R45812.1	–	12.10	0.4764	60.0	107.0	45.0	14.00
R45812.2	–	12.20	0.4803	60.0	107.0	45.0	14.00
R45831/64	31/64	12.30	0.4844	60.0	107.0	45.0	14.00
R45812.5	–	12.50	0.4921	60.0	107.0	45.0	14.00
R45812.7	–	12.70	0.5000	60.0	107.0	45.0	14.00
R4581/2	1/2	12.70	0.5000	60.0	107.0	45.0	14.00
R45812.8	–	12.80	0.5039	60.0	107.0	45.0	14.00
R45813.0	–	13.00	0.5118	60.0	107.0	45.0	14.00
R45833/64	33/64	13.10	0.5156	60.0	107.0	45.0	14.00
R45813.3	–	13.30	0.5236	60.0	107.0	45.0	14.00
R45817/32	17/32	13.49	0.5313	60.0	107.0	45.0	14.00
R45813.5	–	13.50	0.5315	60.0	107.0	45.0	14.00
R45813.8	–	13.80	0.5433	60.0	107.0	45.0	14.00
R45835/64	35/64	13.89	0.5469	60.0	107.0	45.0	14.00
R45814.0	–	14.00	0.5512	60.0	107.0	45.0	14.00
R45814.25	–	14.25	0.5610	65.0	115.0	48.0	16.00
R4589/16	9/16	14.29	0.5625	65.0	115.0	48.0	16.00
R45814.5	–	14.50	0.5709	65.0	115.0	48.0	16.00
R45837/64	37/64	14.68	0.5781	65.0	115.0	48.0	16.00
R45814.8	–	14.80	0.5827	65.0	115.0	48.0	16.00
R45815.0	–	15.00	0.5906	65.0	115.0	48.0	16.00
R45819/32	19/32	15.08	0.5938	65.0	115.0	48.0	16.00
R45815.1	–	15.10	0.5945	65.0	115.0	48.0	16.00
R45815.3	–	15.30	0.6024	65.0	115.0	48.0	16.00
R45839/64	39/64	15.48	0.6094	65.0	115.0	48.0	16.00
R45815.5	–	15.50	0.6102	65.0	115.0	48.0	16.00
R45815.8	–	15.80	0.6220	65.0	115.0	48.0	16.00
R4585/8	5/8	15.88	0.6250	65.0	115.0	48.0	16.00
R45816.0	–	16.00	0.6299	65.0	115.0	48.0	16.00
R45841/64	41/64	16.27	0.6406	73.0	123.0	48.0	18.00
R45816.5	–	16.50	0.6496	73.0	123.0	48.0	18.00
R45821/32	21/32	16.67	0.6563	73.0	123.0	48.0	18.00
R45817.0	–	17.00	0.6693	73.0	123.0	48.0	18.00
R45843/64	43/64	17.07	0.6720	73.0	123.0	48.0	18.00
R45811/16	11/16	17.46	0.6874	73.0	123.0	48.0	18.00
R45817.5	–	17.50	0.6890	73.0	123.0	48.0	18.00
R45817.8	–	17.80	0.7008	73.0	123.0	48.0	18.00
R45845/64	45/64	17.86	0.7031	73.0	123.0	48.0	18.00
R45818.0	–	18.00	0.7087	73.0	123.0	48.0	18.00
R45823/32	23/32	18.26	0.7189	79.0	131.0	50.0	20.00
R45818.5	–	18.50	0.7283	79.0	131.0	50.0	20.00
R45847/64	47/64	18.65	0.7343	79.0	131.0	50.0	20.00
R45819.0	–	19.00	0.7480	79.0	131.0	50.0	20.00
R4583/4	–	19.05	0.7500	79.0	131.0	50.0	20.00
R45819.5	–	19.50	0.7677	79.0	131.0	50.0	20.00
R45819.8	–	19.80	0.7795	79.0	131.0	50.0	20.00
R45820.0	–	20.00	0.7874	79.0	131.0	50.0	20.00



R457



FORCE X Solid Carbide 3XD Drill with Coolant Feed, TiAlN Coated

High performance drill, able to produce high quality and accurate holes at high speeds and feeds (H9 hole tolerance). Self centering 140°, 4-facet split point and CTW flute construction for enhanced penetration rates. Coolant holes to enhance chip evacuation. TiAlN coating increases surface hardness and improves tool life.

FORCE X

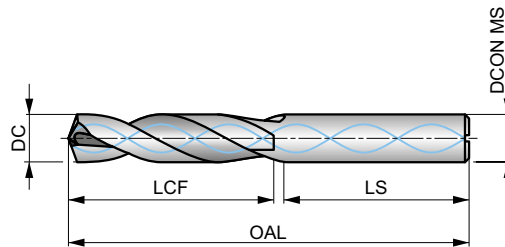

HM	DIN 6537K	3xD
140°	TiAlN	DIN 6535HA
CTW	DC m7	

Workpiece material group suitability, starting values for cutting speed (m/min) and feed Alpha Code. Tables with feed per revolution can be found starting from page 65.

P1.1 ■ 179 W	P1.2 ■ 200 W	P1.3 ■ 207 W	P2.1 ■ 153 W	P2.2 ■ 135 W	P2.3 ■ 119 V	P3.1 ■ 133 V	P3.2 ■ 107 V	P3.3 ■ 90 V	P4.1 ■ 79 V	P4.2 ■ 67 V	P4.3 ■ 55 U	M1.1 ▣ 75 V	M1.2 ▣ 64 V
M2.1 ▣ 67 V	M2.2 ▣ 55 V	M2.3 ▣ 46 U	M3.1 ▣ 41 V	M3.2 ▣ 35 V	M3.3 ▣ 32 V	M4.1 ▣ 30 U	M4.2 ▣ 26 U	K1.1 ■ 110 W	K1.2 ■ 81 W	K1.3 ■ 61 W	K2.1 ■ 98 V	K2.2 ■ 80 V	K2.3 ■ 64 V
K3.1 ■ 87 V	K3.2 ■ 67 V	K3.3 ■ 54 V	K4.1 ■ 81 V	K4.2 ■ 61 V	K4.3 ■ 45 V	K4.4 ■ 38 V	K4.5 ■ 32 V	K5.1 ■ 91 V	K5.2 ■ 69 V	K5.3 ■ 53 V	N1.1 ■ 250 W	N1.2 ■ 188 W	N1.3 ■ 125 W
N2.1 ■ 308 V	N2.2 ■ 277 V	N2.3 ■ 200 V	N3.1 ■ 373 W	N3.2 ■ 220 W	N3.3 ■ 110 W	S1.1 ■ 55 V	S1.2 ■ 45 V	S1.3 ■ 40 U	H1.1 ■ 56 U	H2.1 ▣ 33 U	H2.2 ▣ 30 U	H3.1 ▣ 37 U	H3.2 ▣ 30 U

DCON MS tolerance h6.

Product	DC	DC	DC	LCF	OAL	LS	DCON MS
	[inch]	[mm]	[inch]	[mm]	[mm]	[mm]	[mm]
R4573.0	—	3.00	0.1181	20.0	62.0	36.0	6.00
R4573.1	—	3.10	0.1220	20.0	62.0	36.0	6.00
R4571/8	1/8	3.18	0.1250	20.0	62.0	36.0	6.00
R4573.2	—	3.20	0.1260	20.0	62.0	36.0	6.00
R457N30	N30	3.26	0.1283	20.0	62.0	36.0	6.00
R4573.3	—	3.30	0.1299	20.0	62.0	36.0	6.00
R4573.4	—	3.40	0.1339	20.0	62.0	36.0	6.00
R457N29	N29	3.45	0.1360	20.0	62.0	36.0	6.00
R4573.5	—	3.50	0.1378	20.0	62.0	36.0	6.00
R457N28	N28	3.57	0.1406	20.0	62.0	36.0	6.00
R4579/64	9/64	3.57	0.1406	20.0	62.0	36.0	6.00
R4573.6	—	3.60	0.1417	20.0	62.0	36.0	6.00
R457N27	N27	3.66	0.1441	20.0	62.0	36.0	6.00
R4573.7	—	3.70	0.1457	20.0	62.0	36.0	6.00
R457N26	N26	3.73	0.1469	24.0	66.0	36.0	6.00
R457N25	N25	3.80	0.1496	24.0	66.0	36.0	6.00
R4573.8	—	3.80	0.1496	24.0	66.0	36.0	6.00
R457N24	N24	3.86	0.1520	24.0	66.0	36.0	6.00
R4573.9	—	3.90	0.1535	24.0	66.0	36.0	6.00
R457N23	N23	3.91	0.1539	24.0	66.0	36.0	6.00
R4575/32	5/32	3.97	0.1563	24.0	66.0	36.0	6.00
R457N22	N22	3.99	0.1571	24.0	66.0	36.0	6.00
R4574.0	—	4.00	0.1575	24.0	66.0	36.0	6.00
R457N21	N21	4.04	0.1591	24.0	66.0	36.0	6.00
R4574.05	—	4.05	0.1594	24.0	66.0	36.0	6.00



Product	DC	DC	DC	LCF	OAL	LS	DCON MS
	[inch]	[mm]	[inch]	[mm]	[mm]	[mm]	[mm]
R457N20	N20	4.09	0.1610	24.0	66.0	36.0	6.00
R4574.1	–	4.10	0.1614	24.0	66.0	36.0	6.00
R4574.2	–	4.20	0.1654	24.0	66.0	36.0	6.00
R457N19	N19	4.22	0.1661	24.0	66.0	36.0	6.00
R4574.3	–	4.30	0.1693	24.0	66.0	36.0	6.00
R457N18	N18	4.31	0.1697	24.0	66.0	36.0	6.00
R45711/64	11/64	4.37	0.1719	24.0	66.0	36.0	6.00
R457N17	N17	4.39	0.1728	24.0	66.0	36.0	6.00
R4574.4	–	4.40	0.1732	24.0	66.0	36.0	6.00
R4574.5	–	4.50	0.1772	24.0	66.0	36.0	6.00
R457N16	N16	4.50	0.1772	24.0	66.0	36.0	6.00
R457N15	N15	4.57	0.1799	24.0	66.0	36.0	6.00
R4574.6	–	4.60	0.1811	24.0	66.0	36.0	6.00
R457N14	N14	4.62	0.1819	24.0	66.0	36.0	6.00
R457N13	N13	4.70	0.1850	24.0	66.0	36.0	6.00
R4574.7	–	4.70	0.1850	24.0	66.0	36.0	6.00
R4573/16	3/16	4.76	0.1875	28.0	66.0	36.0	6.00
R4574.8	–	4.80	0.1890	28.0	66.0	36.0	6.00
R457N12	N12	4.80	0.1890	28.0	66.0	36.0	6.00
R457N11	N11	4.85	0.1909	28.0	66.0	36.0	6.00
R4574.9	–	4.90	0.1929	28.0	66.0	36.0	6.00
R457N10	N10	4.92	0.1937	28.0	66.0	36.0	6.00
R457N9	N9	4.98	0.1961	28.0	66.0	36.0	6.00
R4575.0	–	5.00	0.1969	28.0	66.0	36.0	6.00
R4575.05	–	5.05	0.1988	28.0	66.0	36.0	6.00
R457N8	N8	5.06	0.1992	28.0	66.0	36.0	6.00
R4575.1	–	5.10	0.2008	28.0	66.0	36.0	6.00
R457N7	N7	5.11	0.2010	28.0	66.0	36.0	6.00
R45713/64	13/64	5.16	0.2031	28.0	66.0	36.0	6.00
R457N6	N6	5.18	0.2039	28.0	66.0	36.0	6.00
R4575.2	–	5.20	0.2047	28.0	66.0	36.0	6.00
R457N5	N5	5.22	0.2055	28.0	66.0	36.0	6.00
R4575.3	–	5.30	0.2087	28.0	66.0	36.0	6.00
R457N4	N4	5.31	0.2091	28.0	66.0	36.0	6.00
R4575.4	–	5.40	0.2126	28.0	66.0	36.0	6.00
R457N3	N3	5.41	0.2130	28.0	66.0	36.0	6.00
R4575.5	–	5.50	0.2165	28.0	66.0	36.0	6.00
R4577/32	7/32	5.56	0.2188	28.0	66.0	36.0	6.00
R4575.6	–	5.60	0.2205	28.0	66.0	36.0	6.00
R457N2	N2	5.61	0.2209	28.0	66.0	36.0	6.00
R4575.7	–	5.70	0.2244	28.0	66.0	36.0	6.00
R457N1	N1	5.79	0.2280	28.0	66.0	36.0	6.00
R4575.8	–	5.80	0.2283	28.0	66.0	36.0	6.00
R4575.9	–	5.90	0.2323	28.0	66.0	36.0	6.00
R457A	A	5.94	0.2339	28.0	66.0	36.0	6.00
R45715/64	15/64	5.95	0.2344	28.0	66.0	36.0	6.00
R4576.0	–	6.00	0.2362	28.0	66.0	36.0	6.00
R457B	B	6.05	0.2380	34.0	79.0	36.0	8.00
R4576.05	–	6.05	0.2382	34.0	79.0	36.0	8.00
R4576.1	–	6.10	0.2402	34.0	79.0	36.0	8.00
R457C	C	6.15	0.2421	34.0	79.0	36.0	8.00
R4576.2	–	6.20	0.2441	34.0	79.0	36.0	8.00
R457D	D	6.25	0.2461	34.0	79.0	36.0	8.00
R4576.3	–	6.30	0.2480	34.0	79.0	36.0	8.00
R4571/4	1/4	6.35	0.2500	34.0	79.0	36.0	8.00
R457E	E	6.35	0.2500	34.0	79.0	36.0	8.00
R4576.4	–	6.40	0.2520	34.0	79.0	36.0	8.00
R4576.5	–	6.50	0.2559	34.0	79.0	36.0	8.00
R457F	F	6.53	0.2571	34.0	79.0	36.0	8.00
R4576.6	–	6.60	0.2598	34.0	79.0	36.0	8.00
R457G	G	6.63	0.2610	34.0	79.0	36.0	8.00
R4576.7	–	6.70	0.2638	34.0	79.0	36.0	8.00
R45717/64	17/64	6.75	0.2656	34.0	79.0	36.0	8.00
R457H	H	6.76	0.2661	34.0	79.0	36.0	8.00
R4576.8	–	6.80	0.2677	34.0	79.0	36.0	8.00



Product	DC	DC	DC	LCF	OAL	LS	DCON MS
	[inch]	[mm]	[inch]	[mm]	[mm]	[mm]	[mm]
R4576.9	—	6.90	0.2717	34.0	79.0	36.0	8.00
R457I	I	6.91	0.2720	34.0	79.0	36.0	8.00
R4577.0	—	7.00	0.2756	34.0	79.0	36.0	8.00
R457J	J	7.04	0.2772	41.0	79.0	36.0	8.00
R4577.1	—	7.10	0.2795	41.0	79.0	36.0	8.00
R457K	K	7.14	0.2811	41.0	79.0	36.0	8.00
R4579/32	9/32	7.14	0.2813	41.0	79.0	36.0	8.00
R4577.2	—	7.20	0.2835	41.0	79.0	36.0	8.00
R4577.3	—	7.30	0.2874	41.0	79.0	36.0	8.00
R457L	L	7.37	0.2902	41.0	79.0	36.0	8.00
R4577.4	—	7.40	0.2913	41.0	79.0	36.0	8.00
R457M	M	7.49	0.2949	41.0	79.0	36.0	8.00
R4577.5	—	7.50	0.2953	41.0	79.0	36.0	8.00
R45719/64	19/64	7.54	0.2969	41.0	79.0	36.0	8.00
R4577.6	—	7.60	0.2992	41.0	79.0	36.0	8.00
R457N	N	7.67	0.3020	41.0	79.0	36.0	8.00
R4577.7	—	7.70	0.3031	41.0	79.0	36.0	8.00
R4577.8	—	7.80	0.3071	41.0	79.0	36.0	8.00
R4577.9	—	7.90	0.3110	41.0	79.0	36.0	8.00
R4575/16	5/16	7.94	0.3125	41.0	79.0	36.0	8.00
R4578.0	—	8.00	0.3150	41.0	79.0	36.0	8.00
R457O	O	8.03	0.3161	47.0	89.0	40.0	10.00
R4578.05	—	8.05	0.3169	47.0	89.0	40.0	10.00
R4578.1	—	8.10	0.3189	47.0	89.0	40.0	10.00
R4578.2	—	8.20	0.3228	47.0	89.0	40.0	10.00
R457P	P	8.20	0.3228	47.0	89.0	40.0	10.00
R4578.3	—	8.30	0.3268	47.0	89.0	40.0	10.00
R45721/64	21/64	8.33	0.3281	47.0	89.0	40.0	10.00
R4578.4	—	8.40	0.3307	47.0	89.0	40.0	10.00
R457Q	Q	8.43	0.3319	47.0	89.0	40.0	10.00
R4578.5	—	8.50	0.3346	47.0	89.0	40.0	10.00
R4578.6	—	8.60	0.3386	47.0	89.0	40.0	10.00
R457R	R	8.61	0.3390	47.0	89.0	40.0	10.00
R4578.7	—	8.70	0.3425	47.0	89.0	40.0	10.00
R45711/32	11/32	8.73	0.3438	47.0	89.0	40.0	10.00
R4578.8	—	8.80	0.3465	47.0	89.0	40.0	10.00
R457S	S	8.84	0.3480	47.0	89.0	40.0	10.00
R4578.9	—	8.90	0.3504	47.0	89.0	40.0	10.00
R4579.0	—	9.00	0.3543	47.0	89.0	40.0	10.00
R457T	T	9.09	0.3579	47.0	89.0	40.0	10.00
R4579.1	—	9.10	0.3583	47.0	89.0	40.0	10.00
R45723/64	23/64	9.13	0.3594	47.0	89.0	40.0	10.00
R4579.2	—	9.20	0.3622	47.0	89.0	40.0	10.00
R4579.3	—	9.30	0.3661	47.0	89.0	40.0	10.00
R457U	U	9.35	0.3681	47.0	89.0	40.0	10.00
R4579.4	—	9.40	0.3701	47.0	89.0	40.0	10.00
R4579.5	—	9.50	0.3740	47.0	89.0	40.0	10.00
R4573/8	3/8	9.53	0.3750	47.0	89.0	40.0	10.00
R457V	V	9.58	0.3772	47.0	89.0	40.0	10.00
R4579.6	—	9.60	0.3780	47.0	89.0	40.0	10.00
R4579.7	—	9.70	0.3819	47.0	89.0	40.0	10.00
R4579.8	—	9.80	0.3858	47.0	89.0	40.0	10.00
R457W	W	9.80	0.3858	47.0	89.0	40.0	10.00
R4579.9	—	9.90	0.3898	47.0	89.0	40.0	10.00
R45725/64	25/64	9.92	0.3906	47.0	89.0	40.0	10.00
R45710.0	—	10.00	0.3937	47.0	89.0	40.0	10.00
R45710.05	—	10.05	0.3957	55.0	102.0	45.0	12.00
R457X	X	10.08	0.3969	55.0	102.0	45.0	12.00
R45710.1	—	10.10	0.3976	55.0	102.0	45.0	12.00
R45710.2	—	10.20	0.4016	55.0	102.0	45.0	12.00
R457Y	Y	10.26	0.4039	55.0	102.0	45.0	12.00
R45710.3	—	10.30	0.4055	55.0	102.0	45.0	12.00
R45713/32	13/32	10.32	0.4063	55.0	102.0	45.0	12.00
R45710.4	—	10.40	0.4094	55.0	102.0	45.0	12.00
R457Z	Z	10.49	0.4130	55.0	102.0	45.0	12.00



Product	DC	DC	DC	LCF	OAL	LS	DCON MS
	[inch]	[mm]	[inch]	[mm]	[mm]	[mm]	[mm]
R45710.5	–	10.50	0.4134	55.0	102.0	45.0	12.00
R45710.6	–	10.60	0.4173	55.0	102.0	45.0	12.00
R45727/64	27/64	10.72	0.4219	55.0	102.0	45.0	12.00
R45710.8	–	10.80	0.4252	55.0	102.0	45.0	12.00
R45711.0	–	11.00	0.4331	55.0	102.0	45.0	12.00
R4577/16	7/16	11.11	0.4375	55.0	102.0	45.0	12.00
R45711.2	–	11.20	0.4409	55.0	102.0	45.0	12.00
R45711.3	–	11.30	0.4449	55.0	102.0	45.0	12.00
R45711.4	–	11.40	0.4488	55.0	102.0	45.0	12.00
R45711.5	–	11.50	0.4528	55.0	102.0	45.0	12.00
R45729/64	29/64	11.51	0.4531	55.0	102.0	45.0	12.00
R45711.6	–	11.60	0.4567	55.0	102.0	45.0	12.00
R45711.8	–	11.80	0.4646	55.0	102.0	45.0	12.00
R45715/32	15/32	11.91	0.4688	55.0	102.0	45.0	12.00
R45712.0	–	12.00	0.4724	55.0	102.0	45.0	12.00
R45712.05	–	12.05	0.4744	60.0	107.0	45.0	14.00
R45712.1	–	12.10	0.4764	60.0	107.0	45.0	14.00
R45712.2	–	12.20	0.4803	60.0	107.0	45.0	14.00
R45731/64	31/64	12.30	0.4844	60.0	107.0	45.0	14.00
R45712.5	–	12.50	0.4921	60.0	107.0	45.0	14.00
R45712.7	–	12.70	0.5000	60.0	107.0	45.0	14.00
R4571/2	1/2	12.70	0.5000	60.0	107.0	45.0	14.00
R45712.8	–	12.80	0.5039	60.0	107.0	45.0	14.00
R45713.0	–	13.00	0.5118	60.0	107.0	45.0	14.00
R45733/64	33/64	13.10	0.5156	60.0	107.0	45.0	14.00
R45713.3	–	13.30	0.5236	60.0	107.0	45.0	14.00
R45717/32	17/32	13.49	0.5313	60.0	107.0	45.0	14.00
R45713.5	–	13.50	0.5315	60.0	107.0	45.0	14.00
R45713.8	–	13.80	0.5433	60.0	107.0	45.0	14.00
R45735/64	35/64	13.89	0.5469	60.0	107.0	45.0	14.00
R45714.0	–	14.00	0.5512	60.0	107.0	45.0	14.00
R45714.25	–	14.25	0.5610	65.0	115.0	48.0	16.00
R4579/16	9/16	14.29	0.5625	65.0	115.0	48.0	16.00
R45714.5	–	14.50	0.5709	65.0	115.0	48.0	16.00
R45737/64	37/64	14.68	0.5781	65.0	115.0	48.0	16.00
R45714.8	–	14.80	0.5827	65.0	115.0	48.0	16.00
R45715.0	–	15.00	0.5906	65.0	115.0	48.0	16.00
R45719/32	19/32	15.08	0.5938	65.0	115.0	48.0	16.00
R45715.1	–	15.10	0.5945	65.0	115.0	48.0	16.00
R45715.3	–	15.30	0.6024	65.0	115.0	48.0	16.00
R45739/64	39/64	15.48	0.6094	65.0	115.0	48.0	16.00
R45715.5	–	15.50	0.6102	65.0	115.0	48.0	16.00
R45715.8	–	15.80	0.6220	65.0	115.0	48.0	16.00
R4575/8	5/8	15.88	0.6250	65.0	115.0	48.0	16.00
R45716.0	–	16.00	0.6299	65.0	115.0	48.0	16.00
R45741/64	41/64	16.27	0.6406	73.0	123.0	48.0	18.00
R45716.5	–	16.50	0.6496	73.0	123.0	48.0	18.00
R45721/32	21/32	16.67	0.6563	73.0	123.0	48.0	18.00
R45717.0	–	17.00	0.6693	73.0	123.0	48.0	18.00
R45743/64	43/64	17.07	0.6720	73.0	123.0	48.0	18.00
R45711/16	11/16	17.46	0.6874	73.0	123.0	48.0	18.00
R45717.5	–	17.50	0.6890	73.0	123.0	48.0	18.00
R45745/64	45/64	17.86	0.7031	73.0	123.0	48.0	18.00
R45718.0	–	18.00	0.7087	73.0	123.0	48.0	18.00
R45723/32	23/32	18.26	0.7189	79.0	131.0	50.0	20.00
R45718.5	–	18.50	0.7283	79.0	131.0	50.0	20.00
R45747/64	47/64	18.65	0.7343	79.0	131.0	50.0	20.00
R45718.8	–	18.80	0.7402	79.0	131.0	50.0	20.00
R45719.0	–	19.00	0.7480	79.0	131.0	50.0	20.00
R4573/4	3/4	19.05	0.7500	79.0	131.0	50.0	20.00
R45719.5	–	19.50	0.7677	79.0	131.0	50.0	20.00
R45719.8	–	19.80	0.7795	79.0	131.0	50.0	20.00
R45720.0	–	20.00	0.7874	79.0	131.0	50.0	20.00



R454



FORCE X Solid Carbide 5XD Drill, TiAlN Coated

High performance drill, able to produce high quality and accurate holes at high speeds and feeds (H9 hole tolerance). Self centering 140°, 4-facet split point and CTW flute construction for enhanced penetration rates. TiAlN coating increases surface hardness and improves tool life.



FORCE X

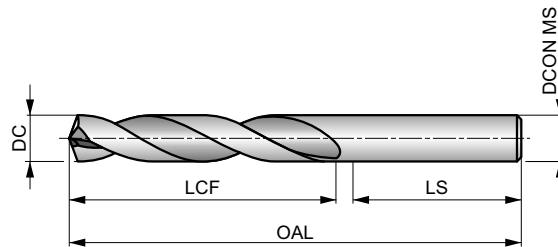

HM	DIN 6537L	5xD
140°	TiAlN	DIN 6535HA
CTW	DC m7	

Workpiece material group suitability, starting values for cutting speed (m/min) and feed Alpha Code. Tables with feed per revolution can be found starting from page 65.

P1.1 ■ 134 V	P1.2 ■ 150 V	P1.3 ■ 155 V	P2.1 ■ 115 V	P2.2 ■ 101 V	P2.3 ■ 89 V	P3.1 ■ 100 V	P3.2 ■ 80 V	P3.3 ■ 68 V	P4.1 ■ 59 V	P4.2 ■ 50 V	P4.3 ■ 41 U	M1.1 ▣ 56 U	M1.2 ▣ 48 U
M2.1 ▣ 50 U	M2.2 ▣ 41 U	M2.3 ▣ 35 T	M3.1 ▣ 31 T	M3.2 ▣ 26 T	M3.3 ▣ 24 T	M4.1 ▣ 23 T	M4.2 ▣ 20 T	K1.1 ■ 83 W	K1.2 ■ 61 W	K1.3 ■ 46 W	K2.1 ■ 74 V	K2.2 ■ 60 V	K2.3 ■ 48 V
K3.1 ■ 65 V	K3.2 ■ 50 V	K3.3 ■ 41 V	K4.1 ■ 61 V	K4.2 ■ 46 V	K4.3 ■ 34 V	K4.4 ■ 29 V	K4.5 ■ 24 V	K5.1 ■ 68 V	K5.2 ■ 52 V	K5.3 ■ 40 V	N1.1 ■ 188 W	N1.2 ■ 141 W	N1.3 ■ 94 W
N2.1 ■ 231 V	N2.2 ■ 208 V	N2.3 ■ 150 V	N3.1 ■ 280 V	N3.2 ■ 165 V	N3.3 ■ 83 V	S1.1 ▣ 41 U	S1.2 ▣ 34 U	S1.3 ▣ 30 T	H1.1 ■ 42 U	H2.1 ▣ 25 U	H2.2 ▣ 23 U	H3.1 ▣ 28 U	H3.2 ▣ 23 U

DCON MS tolerance h6.

Product	DC	DC	DC	LCF	OAL	LS	DCON MS
	[inch]	[mm]	[inch]	[mm]	[mm]	[mm]	[mm]
R4543.0	—	3.00	0.1181	28.0	66.0	36.0	6.00
R4543.1	—	3.10	0.1220	28.0	66.0	36.0	6.00
R4541/8	1/8	3.18	0.1250	28.0	66.0	36.0	6.00
R4543.2	—	3.20	0.1260	28.0	66.0	36.0	6.00
R454N30	N30	3.26	0.1283	28.0	66.0	36.0	6.00
R4543.3	—	3.30	0.1299	28.0	66.0	36.0	6.00
R4543.4	—	3.40	0.1339	28.0	66.0	36.0	6.00
R454N29	N29	3.45	0.1360	28.0	66.0	36.0	6.00
R4543.5	—	3.50	0.1378	28.0	66.0	36.0	6.00
R454N28	N28	3.57	0.1406	28.0	66.0	36.0	6.00
R4549/64	9/64	3.57	0.1406	28.0	66.0	36.0	6.00
R4543.6	—	3.60	0.1417	28.0	66.0	36.0	6.00
R454N27	N27	3.66	0.1441	28.0	66.0	36.0	6.00
R4543.7	—	3.70	0.1457	28.0	66.0	36.0	6.00
R454N26	N26	3.73	0.1469	36.0	74.0	36.0	6.00
R454N25	N25	3.80	0.1496	36.0	74.0	36.0	6.00
R4543.8	—	3.80	0.1496	36.0	74.0	36.0	6.00
R454N24	N24	3.86	0.1520	36.0	74.0	36.0	6.00
R4543.9	—	3.90	0.1535	36.0	74.0	36.0	6.00
R454N23	N23	3.91	0.1539	36.0	74.0	36.0	6.00
R4545/32	5/32	3.97	0.1563	36.0	74.0	36.0	6.00
R454N22	N22	3.99	0.1571	36.0	74.0	36.0	6.00
R4544.0	—	4.00	0.1575	36.0	74.0	36.0	6.00
R454N21	N21	4.04	0.1591	36.0	74.0	36.0	6.00
R454N20	N20	4.09	0.1610	36.0	74.0	36.0	6.00



Product	DC	DC	DC	LCF	OAL	LS	DCON MS
	[inch]	[mm]	[inch]	[mm]	[mm]	[mm]	[mm]
R4544.1	–	4.10	0.1614	36.0	74.0	36.0	6.00
R4544.2	–	4.20	0.1654	36.0	74.0	36.0	6.00
R454N19	N19	4.22	0.1661	36.0	74.0	36.0	6.00
R4544.3	–	4.30	0.1693	36.0	74.0	36.0	6.00
R454N18	N18	4.31	0.1697	36.0	74.0	36.0	6.00
R45411/64	11/64	4.37	0.1719	36.0	74.0	36.0	6.00
R454N17	N17	4.39	0.1728	36.0	74.0	36.0	6.00
R4544.4	–	4.40	0.1732	36.0	74.0	36.0	6.00
R4544.5	–	4.50	0.1772	36.0	74.0	36.0	6.00
R454N16	N16	4.50	0.1772	36.0	74.0	36.0	6.00
R454N15	N15	4.57	0.1799	36.0	74.0	36.0	6.00
R4544.6	–	4.60	0.1811	36.0	74.0	36.0	6.00
R454N14	N14	4.62	0.1819	36.0	74.0	36.0	6.00
R454N13	N13	4.70	0.1850	36.0	74.0	36.0	6.00
R4544.7	–	4.70	0.1850	36.0	74.0	36.0	6.00
R4543/16	3/16	4.76	0.1875	44.0	82.0	36.0	6.00
R454N12	N12	4.80	0.1890	44.0	82.0	36.0	6.00
R4544.8	–	4.80	0.1890	44.0	82.0	36.0	6.00
R454N11	N11	4.85	0.1909	44.0	82.0	36.0	6.00
R4544.9	–	4.90	0.1929	44.0	82.0	36.0	6.00
R454N10	N10	4.92	0.1937	44.0	82.0	36.0	6.00
R454N9	N9	4.98	0.1961	44.0	82.0	36.0	6.00
R4545.0	–	5.00	0.1969	44.0	82.0	36.0	6.00
R454N8	N8	5.06	0.1992	44.0	82.0	36.0	6.00
R4545.1	–	5.10	0.2008	44.0	82.0	36.0	6.00
R454N7	N7	5.11	0.2010	44.0	82.0	36.0	6.00
R45413/64	13/64	5.16	0.2031	44.0	82.0	36.0	6.00
R454N6	N6	5.18	0.2039	44.0	82.0	36.0	6.00
R4545.2	–	5.20	0.2047	44.0	82.0	36.0	6.00
R454N5	N5	5.22	0.2055	44.0	82.0	36.0	6.00
R454N4	N4	5.31	0.2091	44.0	82.0	36.0	6.00
R454N3	N3	5.41	0.2130	44.0	82.0	36.0	6.00
R4545.5	–	5.50	0.2165	44.0	82.0	36.0	6.00
R4547/32	7/32	5.56	0.2188	44.0	82.0	36.0	6.00
R4545.6	–	5.60	0.2205	44.0	82.0	36.0	6.00
R454N2	N2	5.61	0.2209	44.0	82.0	36.0	6.00
R4545.7	–	5.70	0.2244	44.0	82.0	36.0	6.00
R454N1	N1	5.79	0.2280	44.0	82.0	36.0	6.00
R4545.8	–	5.80	0.2283	44.0	82.0	36.0	6.00
R454A	A	5.94	0.2339	44.0	82.0	36.0	6.00
R45415/64	15/64	5.95	0.2344	44.0	82.0	36.0	6.00
R4546.0	–	6.00	0.2362	44.0	82.0	36.0	6.00
R454B	B	6.05	0.2380	53.0	91.0	36.0	8.00
R4546.1	–	6.10	0.2402	53.0	91.0	36.0	8.00
R454C	C	6.15	0.2421	53.0	91.0	36.0	8.00
R4546.2	–	6.20	0.2441	53.0	91.0	36.0	8.00
R454D	D	6.25	0.2461	53.0	91.0	36.0	8.00
R4546.3	–	6.30	0.2480	53.0	91.0	36.0	8.00
R4541/4	1/4	6.35	0.2500	53.0	91.0	36.0	8.00
R454E	E	6.35	0.2500	53.0	91.0	36.0	8.00
R4546.4	–	6.40	0.2520	53.0	91.0	36.0	8.00
R4546.5	–	6.50	0.2559	53.0	91.0	36.0	8.00
R454F	F	6.53	0.2571	53.0	91.0	36.0	8.00
R4546.6	–	6.60	0.2598	53.0	91.0	36.0	8.00
R454G	G	6.63	0.2610	53.0	91.0	36.0	8.00
R4546.7	–	6.70	0.2638	53.0	91.0	36.0	8.00
R45417/64	17/64	6.75	0.2656	53.0	91.0	36.0	8.00
R454H	H	6.76	0.2661	53.0	91.0	36.0	8.00
R4546.8	–	6.80	0.2677	53.0	91.0	36.0	8.00
R4546.9	–	6.90	0.2717	53.0	91.0	36.0	8.00
R454I	I	6.91	0.2720	53.0	91.0	36.0	8.00
R4547.0	–	7.00	0.2756	53.0	91.0	36.0	8.00



Product	DC	DC	DC	LCF	OAL	LS	DCON MS
	[inch]	[mm]	[inch]	[mm]	[mm]	[mm]	[mm]
R454J	J	7.04	0.2772	53.0	91.0	36.0	8.00
R4547.1	–	7.10	0.2795	53.0	91.0	36.0	8.00
R454K	K	7.14	0.2811	53.0	91.0	36.0	8.00
R4549/32	9/32	7.14	0.2813	53.0	91.0	36.0	8.00
R4547.3	–	7.30	0.2874	53.0	91.0	36.0	8.00
R454L	L	7.37	0.2902	53.0	91.0	36.0	8.00
R4547.4	–	7.40	0.2913	53.0	91.0	36.0	8.00
R454M	M	7.49	0.2949	53.0	91.0	36.0	8.00
R4547.5	–	7.50	0.2953	53.0	91.0	36.0	8.00
R45419/64	19/64	7.54	0.2969	53.0	91.0	36.0	8.00
R4547.6	–	7.60	0.2992	53.0	91.0	36.0	8.00
R454N	N	7.67	0.3020	53.0	91.0	36.0	8.00
R4547.7	–	7.70	0.3031	53.0	91.0	36.0	8.00
R4547.8	–	7.80	0.3071	53.0	91.0	36.0	8.00
R4547.9	–	7.90	0.3110	53.0	91.0	36.0	8.00
R4545/16	5/16	7.94	0.3125	53.0	91.0	36.0	8.00
R4548.0	–	8.00	0.3150	53.0	91.0	36.0	8.00
R4540	O	8.03	0.3161	61.0	103.0	40.0	10.00
R4548.1	–	8.10	0.3189	61.0	103.0	40.0	10.00
R4548.2	–	8.20	0.3228	61.0	103.0	40.0	10.00
R454P	P	8.20	0.3228	61.0	103.0	40.0	10.00
R45421/64	21/64	8.33	0.3281	61.0	103.0	40.0	10.00
R4548.4	–	8.40	0.3307	61.0	103.0	40.0	10.00
R454Q	Q	8.43	0.3319	61.0	103.0	40.0	10.00
R4548.5	–	8.50	0.3346	61.0	103.0	40.0	10.00
R4548.6	–	8.60	0.3386	61.0	103.0	40.0	10.00
R454R	R	8.61	0.3390	61.0	103.0	40.0	10.00
R4548.7	–	8.70	0.3425	61.0	103.0	40.0	10.00
R45411/32	11/32	8.73	0.3438	61.0	103.0	40.0	10.00
R4548.8	–	8.80	0.3465	61.0	103.0	40.0	10.00
R454S	S	8.84	0.3480	61.0	103.0	40.0	10.00
R4548.9	–	8.90	0.3504	61.0	103.0	40.0	10.00
R4549.0	–	9.00	0.3543	61.0	103.0	40.0	10.00
R454T	T	9.09	0.3579	61.0	103.0	40.0	10.00
R4549.1	–	9.10	0.3583	61.0	103.0	40.0	10.00
R45423/64	23/64	9.13	0.3594	61.0	103.0	40.0	10.00
R4549.3	–	9.30	0.3661	61.0	103.0	40.0	10.00
R454U	U	9.35	0.3681	61.0	103.0	40.0	10.00
R4549.4	–	9.40	0.3701	61.0	103.0	40.0	10.00
R4549.5	–	9.50	0.3740	61.0	103.0	40.0	10.00
R4543/8	3/8	9.53	0.3750	61.0	103.0	40.0	10.00
R454V	V	9.58	0.3772	61.0	103.0	40.0	10.00
R4549.6	–	9.60	0.3780	61.0	103.0	40.0	10.00
R4549.7	–	9.70	0.3819	61.0	103.0	40.0	10.00
R4549.8	–	9.80	0.3858	61.0	103.0	40.0	10.00
R4549.9	–	9.90	0.3898	61.0	103.0	40.0	10.00
R454W	W	9.80	0.3858	61.0	103.0	40.0	10.00
R45425/64	25/64	9.92	0.3906	61.0	103.0	40.0	10.00
R45410.0	–	10.00	0.3937	61.0	103.0	40.0	10.00
R454X	X	10.08	0.3969	70.0	118.0	45.0	12.00
R45410.1	–	10.10	0.3976	70.0	118.0	45.0	12.00
R45410.2	–	10.20	0.4016	70.0	118.0	45.0	12.00
R454Y	Y	10.26	0.4039	70.0	118.0	45.0	12.00
R45410.3	–	10.30	0.4055	70.0	118.0	45.0	12.00
R45413/32	13/32	10.32	0.4063	70.0	118.0	45.0	12.00
R45410.4	–	10.40	0.4094	70.0	118.0	45.0	12.00
R454Z	Z	10.49	0.4130	70.0	118.0	45.0	12.00
R45410.5	–	10.50	0.4134	70.0	118.0	45.0	12.00
R45410.6	–	10.60	0.4173	70.0	118.0	45.0	12.00
R45427/64	27/64	10.72	0.4219	70.0	118.0	45.0	12.00
R45411.0	–	11.00	0.4331	70.0	118.0	45.0	12.00
R4547/16	7/16	11.11	0.4375	70.0	118.0	45.0	12.00



Product	DC	DC	DC	LCF	OAL	LS	DCON MS
	[inch]	[mm]	[inch]	[mm]	[mm]	[mm]	[mm]
R45411.2	–	11.20	0.4409	70.0	118.0	45.0	12.00
R45411.4	–	11.40	0.4488	70.0	118.0	45.0	12.00
R45411.5	–	11.50	0.4528	70.0	118.0	45.0	12.00
R45429/64	29/64	11.51	0.4531	70.0	118.0	45.0	12.00
R45411.6	–	11.60	0.4567	70.0	118.0	45.0	12.00
R45411.8	–	11.80	0.4646	70.0	118.0	45.0	12.00
R45415/32	15/32	11.91	0.4688	70.0	118.0	45.0	12.00
R45412.0	–	12.00	0.4724	70.0	118.0	45.0	12.00
R45412.1	–	12.10	0.4764	76.0	124.0	45.0	14.00
R45412.2	–	12.20	0.4803	76.0	124.0	45.0	14.00
R45431/64	31/64	12.30	0.4844	76.0	124.0	45.0	14.00
R45412.5	–	12.50	0.4921	76.0	124.0	45.0	14.00
R45412.7	–	12.70	0.5000	76.0	124.0	45.0	14.00
R4541/2	1/2	12.70	0.5000	76.0	124.0	45.0	14.00
R45412.8	–	12.80	0.5039	76.0	124.0	45.0	14.00
R45413.0	–	13.00	0.5118	76.0	124.0	45.0	14.00
R45433/64	33/64	13.10	0.5156	76.0	124.0	45.0	14.00
R45417/32	17/32	13.49	0.5313	76.0	124.0	45.0	14.00
R45413.5	–	13.50	0.5315	76.0	124.0	45.0	14.00
R45413.8	–	13.80	0.5433	76.0	124.0	45.0	14.00
R45435/64	35/64	13.89	0.5469	76.0	124.0	45.0	14.00
R45414.0	–	14.00	0.5512	76.0	124.0	45.0	14.00
R45414.25	–	14.25	0.5610	82.0	133.0	48.0	16.00
R4549/16	9/16	14.29	0.5625	82.0	133.0	48.0	16.00
R45414.5	–	14.50	0.5709	82.0	133.0	48.0	16.00
R45437/64	37/64	14.68	0.5781	82.0	133.0	48.0	16.00
R45414.8	–	14.80	0.5827	82.0	133.0	48.0	16.00
R45415.0	–	15.00	0.5906	82.0	133.0	48.0	16.00
R45419/32	19/32	15.08	0.5938	82.0	133.0	48.0	16.00
R45415.1	–	15.10	0.5945	82.0	133.0	48.0	16.00
R45439/64	39/64	15.48	0.6094	82.0	133.0	48.0	16.00
R45415.5	–	15.50	0.6102	82.0	133.0	48.0	16.00
R45415.8	–	15.80	0.6220	82.0	133.0	48.0	16.00
R4545/8	5/8	15.88	0.6250	82.0	133.0	48.0	16.00
R45416.0	–	16.00	0.6299	82.0	133.0	48.0	16.00
R45441/64	41/64	16.27	0.6406	91.0	143.0	48.0	18.00
R45416.5	–	16.50	0.6496	91.0	143.0	48.0	18.00
R45421/32	21/32	16.67	0.6563	91.0	143.0	48.0	18.00
R45417.0	–	17.00	0.6693	91.0	143.0	48.0	18.00
R45443/64	43/64	17.07	0.6720	91.0	143.0	48.0	18.00
R45411/16	11/16	17.46	0.6874	91.0	143.0	48.0	18.00
R45417.5	–	17.50	0.6890	91.0	143.0	48.0	18.00
R45417.8	–	17.80	0.7008	91.0	143.0	48.0	18.00
R45445/64	45/64	17.86	0.7031	91.0	143.0	48.0	18.00
R45418.0	–	18.00	0.7087	91.0	143.0	48.0	18.00
R45423/32	23/32	18.26	0.7189	99.0	153.0	50.0	20.00
R45418.5	–	18.50	0.7283	99.0	153.0	50.0	20.00
R45447/64	47/64	18.65	0.7343	99.0	153.0	50.0	20.00
R45419.0	–	19.00	0.7480	99.0	153.0	50.0	20.00
R4543/4	3/4	19.05	0.7500	99.0	153.0	50.0	20.00
R45419.5	–	19.50	0.7677	99.0	153.0	50.0	20.00
R45419.8	–	19.80	0.7795	99.0	153.0	50.0	20.00
R45420.0	–	20.00	0.7874	99.0	153.0	50.0	20.00



R453



FORCE X Solid Carbide 5XD Drill with Coolant Feed, TiAlN Coated

High performance drill, able to produce high quality and accurate holes at high speeds and feeds (H9 hole tolerance). Self centering 140°, 4-facet split point and CTW flute construction for enhanced penetration rates. Coolant holes to enhance chip evacuation. TiAlN coating increases surface hardness and improves tool life.

FORCE X

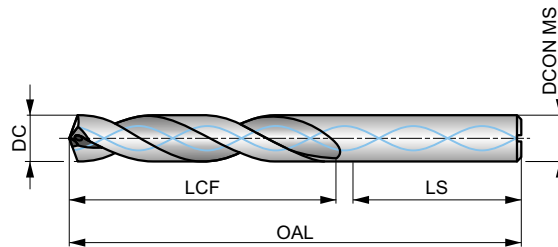

HM	DIN 6537L	5xD
140°	TiAlN	DIN 6535HA
CTW	DC m7	

Workpiece material group suitability, starting values for cutting speed (m/min) and feed Alpha Code. Tables with feed per revolution can be found starting from page 65.

P1.1 ■ 170 V	P1.2 ■ 190 V	P1.3 ■ 197 V	P2.1 ■ 145 V	P2.2 ■ 128 V	P2.3 ■ 113 V	P3.1 ■ 126 V	P3.2 ■ 102 V	P3.3 ■ 86 V	P4.1 ■ 75 V	P4.2 ■ 64 V	P4.3 ■ 52 U	M1.1 ■ 71 V	M1.2 ■ 61 V
M2.1 ■ 64 V	M2.2 ■ 52 V	M2.3 ■ 44 U	M3.1 ■ 39 V	M3.2 ■ 33 V	M3.3 ■ 30 V	M4.1 ■ 29 U	M4.2 ■ 25 U	K1.1 ■ 105 W	K1.2 ■ 77 W	K1.3 ■ 58 W	K2.1 ■ 93 V	K2.2 ■ 76 V	K2.3 ■ 61 V
K3.1 ■ 83 V	K3.2 ■ 64 V	K3.3 ■ 51 V	K4.1 ■ 77 V	K4.2 ■ 58 V	K4.3 ■ 43 V	K4.4 ■ 36 V	K4.5 ■ 30 V	K5.1 ■ 86 V	K5.2 ■ 66 V	K5.3 ■ 50 V	N1.1 ■ 238 W	N1.2 ■ 179 W	N1.3 ■ 119 W
N2.1 ■ 293 V	N2.2 ■ 263 V	N2.3 ■ 190 V	N3.1 ■ 354 W	N3.2 ■ 209 W	N3.3 ■ 105 W	S1.1 ■ 52 V	S1.2 ■ 43 V	S1.3 ■ 38 U	H1.1 ■ 53 U	H2.1 ■ 31 U	H2.2 ■ 29 U	H3.1 ■ 35 U	H3.2 ■ 29 U

DCON MS tolerance h6.

Product	DC [inch]	DC [mm]	DC [inch]	LCF [mm]	OAL [mm]	LS [mm]	DCON MS [mm]
R4533.0	–	3.00	0.1181	28.0	66.0	36.0	6.00
R4533.1	–	3.10	0.1220	28.0	66.0	36.0	6.00
R4531/8	1/8	3.18	0.1250	28.0	66.0	36.0	6.00
R4533.2	–	3.20	0.1260	28.0	66.0	36.0	6.00
R453N30	N30	3.26	0.1283	28.0	66.0	36.0	6.00
R4533.3	–	3.30	0.1299	28.0	66.0	36.0	6.00
R4533.4	–	3.40	0.1339	28.0	66.0	36.0	6.00
R453N29	N29	3.45	0.1360	28.0	66.0	36.0	6.00
R4533.5	–	3.50	0.1378	28.0	66.0	36.0	6.00
R453N28	N28	3.57	0.1406	28.0	66.0	36.0	6.00
R4539/64	9/64	3.57	0.1406	28.0	66.0	36.0	6.00
R4533.6	–	3.60	0.1417	28.0	66.0	36.0	6.00
R453N27	N27	3.66	0.1441	28.0	66.0	36.0	6.00
R4533.7	–	3.70	0.1457	28.0	66.0	36.0	6.00
R453N26	N26	3.73	0.1469	36.0	74.0	36.0	6.00
R453N25	N25	3.80	0.1496	36.0	74.0	36.0	6.00
R4533.8	–	3.80	0.1496	36.0	74.0	36.0	6.00
R453N24	N24	3.86	0.1520	36.0	74.0	36.0	6.00
R4533.9	–	3.90	0.1535	36.0	74.0	36.0	6.00
R453N23	N23	3.91	0.1539	36.0	74.0	36.0	6.00
R4535/32	5/32	3.97	0.1563	36.0	74.0	36.0	6.00
R453N22	N22	3.99	0.1571	36.0	74.0	36.0	6.00
R4534.0	–	4.00	0.1575	36.0	74.0	36.0	6.00
R453N21	N21	4.04	0.1591	36.0	74.0	36.0	6.00
R4534.05	–	4.05	0.1594	36.0	74.0	36.0	6.00



Product	DC	DC	DC	LCF	OAL	LS	DCON MS
	[inch]	[mm]	[inch]	[mm]	[mm]	[mm]	[mm]
R453N20	N20	4.09	0.1610	36.0	74.0	36.0	6.00
R4534.1	–	4.10	0.1614	36.0	74.0	36.0	6.00
R4534.2	–	4.20	0.1654	36.0	74.0	36.0	6.00
R453N19	N19	4.22	0.1661	36.0	74.0	36.0	6.00
R4534.3	–	4.30	0.1693	36.0	74.0	36.0	6.00
R453N18	N18	4.31	0.1697	36.0	74.0	36.0	6.00
R45311/64	11/64	4.37	0.1719	36.0	74.0	36.0	6.00
R453N17	N17	4.39	0.1728	36.0	74.0	36.0	6.00
R4534.4	–	4.40	0.1732	36.0	74.0	36.0	6.00
R4534.5	–	4.50	0.1772	36.0	74.0	36.0	6.00
R453N16	N16	4.50	0.1772	36.0	74.0	36.0	6.00
R453N15	N15	4.57	0.1799	36.0	74.0	36.0	6.00
R4534.6	–	4.60	0.1811	36.0	74.0	36.0	6.00
R453N14	N14	4.62	0.1819	36.0	74.0	36.0	6.00
R453N13	N13	4.70	0.1850	36.0	74.0	36.0	6.00
R4534.7	–	4.70	0.1850	36.0	74.0	36.0	6.00
R4533/16	3/16	4.76	0.1875	44.0	82.0	36.0	6.00
R4534.8	–	4.80	0.1890	44.0	82.0	36.0	6.00
R453N12	N12	4.80	0.1890	44.0	82.0	36.0	6.00
R453N11	N11	4.85	0.1909	44.0	82.0	36.0	6.00
R4534.9	–	4.90	0.1929	44.0	82.0	36.0	6.00
R453N10	N10	4.92	0.1937	44.0	82.0	36.0	6.00
R453N9	N9	4.98	0.1961	44.0	82.0	36.0	6.00
R4535.0	–	5.00	0.1969	44.0	82.0	36.0	6.00
R4535.05	–	5.05	0.1988	44.0	82.0	36.0	6.00
R453N8	N8	5.06	0.1992	44.0	82.0	36.0	6.00
R4535.1	–	5.10	0.2008	44.0	82.0	36.0	6.00
R453N7	N7	5.11	0.2010	44.0	82.0	36.0	6.00
R45313/64	13/64	5.16	0.2031	44.0	82.0	36.0	6.00
R453N6	N6	5.18	0.2039	44.0	82.0	36.0	6.00
R4535.2	–	5.20	0.2047	44.0	82.0	36.0	6.00
R453N5	N5	5.22	0.2055	44.0	82.0	36.0	6.00
R4535.3	–	5.30	0.2087	44.0	82.0	36.0	6.00
R453N4	N4	5.31	0.2091	44.0	82.0	36.0	6.00
R4535.4	–	5.40	0.2126	44.0	82.0	36.0	6.00
R453N3	N3	5.41	0.2130	44.0	82.0	36.0	6.00
R4535.5	–	5.50	0.2165	44.0	82.0	36.0	6.00
R4537/32	7/32	5.56	0.2188	44.0	82.0	36.0	6.00
R4535.6	–	5.60	0.2205	44.0	82.0	36.0	6.00
R453N2	N2	5.61	0.2209	44.0	82.0	36.0	6.00
R4535.7	–	5.70	0.2244	44.0	82.0	36.0	6.00
R453N1	N1	5.79	0.2280	44.0	82.0	36.0	6.00
R4535.8	–	5.80	0.2283	44.0	82.0	36.0	6.00
R4535.9	–	5.90	0.2323	44.0	82.0	36.0	6.00
R453A	A	5.94	0.2339	44.0	82.0	36.0	6.00
R45315/64	15/64	5.95	0.2344	44.0	82.0	36.0	6.00
R4536.0	–	6.00	0.2362	44.0	82.0	36.0	6.00
R453B	B	6.05	0.2380	53.0	91.0	36.0	8.00
R4536.05	–	6.05	0.2382	53.0	91.0	36.0	8.00
R4536.1	–	6.10	0.2402	53.0	91.0	36.0	8.00
R453C	C	6.15	0.2421	53.0	91.0	36.0	8.00
R4536.2	–	6.20	0.2441	53.0	91.0	36.0	8.00
R453D	D	6.25	0.2461	53.0	91.0	36.0	8.00
R4536.3	–	6.30	0.2480	53.0	91.0	36.0	8.00
R4531/4	1/4	6.35	0.2500	53.0	91.0	36.0	8.00
R453E	E	6.35	0.2500	53.0	91.0	36.0	8.00
R4536.4	–	6.40	0.2520	53.0	91.0	36.0	8.00
R4536.5	–	6.50	0.2559	53.0	91.0	36.0	8.00
R453F	F	6.53	0.2571	53.0	91.0	36.0	8.00
R4536.6	–	6.60	0.2598	53.0	91.0	36.0	8.00
R453G	G	6.63	0.2610	53.0	91.0	36.0	8.00
R4536.7	–	6.70	0.2638	53.0	91.0	36.0	8.00
R45317/64	17/64	6.75	0.2656	53.0	91.0	36.0	8.00
R453H	H	6.76	0.2661	53.0	91.0	36.0	8.00
R4536.8	–	6.80	0.2677	53.0	91.0	36.0	8.00



Product	DC	DC	DC	LCF	OAL	LS	DCON MS
	[inch]	[mm]	[inch]	[mm]	[mm]	[mm]	[mm]
R4536.9	–	6.90	0.2717	53.0	91.0	36.0	8.00
R453I	I	6.91	0.2720	53.0	91.0	36.0	8.00
R4537.0	–	7.00	0.2756	53.0	91.0	36.0	8.00
R453J	J	7.04	0.2772	53.0	91.0	36.0	8.00
R4537.1	–	7.10	0.2795	53.0	91.0	36.0	8.00
R453K	K	7.14	0.2811	53.0	91.0	36.0	8.00
R4539/32	9/32	7.14	0.2813	53.0	91.0	36.0	8.00
R4537.2	–	7.20	0.2835	53.0	91.0	36.0	8.00
R4537.3	–	7.30	0.2874	53.0	91.0	36.0	8.00
R453L	L	7.37	0.2902	53.0	91.0	36.0	8.00
R4537.4	–	7.40	0.2913	53.0	91.0	36.0	8.00
R453M	M	7.49	0.2949	53.0	91.0	36.0	8.00
R4537.5	–	7.50	0.2953	53.0	91.0	36.0	8.00
R45319/64	19/64	7.54	0.2969	53.0	91.0	36.0	8.00
R4537.6	–	7.60	0.2992	53.0	91.0	36.0	8.00
R453N	N	7.67	0.3020	53.0	91.0	36.0	8.00
R4537.7	–	7.70	0.3031	53.0	91.0	36.0	8.00
R4537.8	–	7.80	0.3071	53.0	91.0	36.0	8.00
R4537.9	–	7.90	0.3110	53.0	91.0	36.0	8.00
R4535/16	5/16	7.94	0.3125	53.0	91.0	36.0	8.00
R4538.0	–	8.00	0.3150	53.0	91.0	36.0	8.00
R453O	O	8.03	0.3161	61.0	103.0	40.0	10.00
R4538.05	–	8.05	0.3169	61.0	103.0	40.0	10.00
R4538.1	–	8.10	0.3189	61.0	103.0	40.0	10.00
R4538.2	–	8.20	0.3228	61.0	103.0	40.0	10.00
R453P	P	8.20	0.3228	61.0	103.0	40.0	10.00
R4538.3	–	8.30	0.3268	61.0	103.0	40.0	10.00
R45321/64	21/64	8.33	0.3281	61.0	103.0	40.0	10.00
R4538.4	–	8.40	0.3307	61.0	103.0	40.0	10.00
R453Q	Q	8.43	0.3319	61.0	103.0	40.0	10.00
R4538.5	–	8.50	0.3346	61.0	103.0	40.0	10.00
R4538.6	–	8.60	0.3386	61.0	103.0	40.0	10.00
R453R	R	8.61	0.3390	61.0	103.0	40.0	10.00
R4538.7	–	8.70	0.3425	61.0	103.0	40.0	10.00
R45311/32	11/32	8.73	0.3438	61.0	103.0	40.0	10.00
R4538.8	–	8.80	0.3465	61.0	103.0	40.0	10.00
R453S	S	8.84	0.3480	61.0	103.0	40.0	10.00
R4538.9	–	8.90	0.3504	61.0	103.0	40.0	10.00
R4539.0	–	9.00	0.3543	61.0	103.0	40.0	10.00
R453T	T	9.09	0.3579	61.0	103.0	40.0	10.00
R4539.1	–	9.10	0.3583	61.0	103.0	40.0	10.00
R45323/64	23/64	9.13	0.3594	61.0	103.0	40.0	10.00
R4539.2	–	9.20	0.3622	61.0	103.0	40.0	10.00
R4539.3	–	9.30	0.3661	61.0	103.0	40.0	10.00
R453U	U	9.35	0.3681	61.0	103.0	40.0	10.00
R4539.4	–	9.40	0.3701	61.0	103.0	40.0	10.00
R4539.5	–	9.50	0.3740	61.0	103.0	40.0	10.00
R4533/8	3/8	9.53	0.3750	61.0	103.0	40.0	10.00
R453V	V	9.58	0.3772	61.0	103.0	40.0	10.00
R4539.6	–	9.60	0.3780	61.0	103.0	40.0	10.00
R4539.7	–	9.70	0.3819	61.0	103.0	40.0	10.00
R4539.8	–	9.80	0.3858	61.0	103.0	40.0	10.00
R453W	W	9.80	0.3858	61.0	103.0	40.0	10.00
R4539.9	–	9.90	0.3898	61.0	103.0	40.0	10.00
R45325/64	25/64	9.92	0.3906	61.0	103.0	40.0	10.00
R45310.0	–	10.00	0.3937	61.0	103.0	40.0	10.00
R45310.05	–	10.05	0.3957	70.0	118.0	45.0	12.00
R453X	X	10.08	0.3969	70.0	118.0	45.0	12.00
R45310.1	–	10.10	0.3976	70.0	118.0	45.0	12.00
R45310.2	–	10.20	0.4016	70.0	118.0	45.0	12.00
R453Y	Y	10.26	0.4039	70.0	118.0	45.0	12.00
R45310.3	–	10.30	0.4055	70.0	118.0	45.0	12.00
R45313/32	13/32	10.32	0.4063	70.0	118.0	45.0	12.00
R45310.4	–	10.40	0.4094	70.0	118.0	45.0	12.00
R453Z	Z	10.49	0.4130	70.0	118.0	45.0	12.00



Product	DC	DC	DC	LCF	OAL	LS	DCON MS
	[inch]	[mm]	[inch]	[mm]	[mm]	[mm]	[mm]
R45310.5	–	10.50	0.4134	70.0	118.0	45.0	12.00
R45310.6	–	10.60	0.4173	70.0	118.0	45.0	12.00
R45327/64	27/64	10.72	0.4219	70.0	118.0	45.0	12.00
R45310.8	–	10.80	0.4252	70.0	118.0	45.0	12.00
R45311.0	–	11.00	0.4331	70.0	118.0	45.0	12.00
R4537/16	7/16	11.11	0.4375	70.0	118.0	45.0	12.00
R45311.2	–	11.20	0.4409	70.0	118.0	45.0	12.00
R45311.3	–	11.30	0.4449	70.0	118.0	45.0	12.00
R45311.4	–	11.40	0.4488	70.0	118.0	45.0	12.00
R45311.5	–	11.50	0.4528	70.0	118.0	45.0	12.00
R45329/64	29/64	11.51	0.4531	70.0	118.0	45.0	12.00
R45311.6	–	11.60	0.4567	70.0	118.0	45.0	12.00
R45311.8	–	11.80	0.4646	70.0	118.0	45.0	12.00
R45315/32	15/32	11.91	0.4688	70.0	118.0	45.0	12.00
R45312.0	–	12.00	0.4724	70.0	118.0	45.0	12.00
R45312.05	–	12.05	0.4744	76.0	124.0	45.0	14.00
R45312.2	–	12.20	0.4803	76.0	124.0	45.0	14.00
R45331/64	31/64	12.30	0.4844	76.0	124.0	45.0	14.00
R45312.5	–	12.50	0.4921	76.0	124.0	45.0	14.00
R45312.7	–	12.70	0.5000	76.0	124.0	45.0	14.00
R4531/2	1/2	12.70	0.5000	76.0	124.0	45.0	14.00
R45312.8	–	12.80	0.5039	76.0	124.0	45.0	14.00
R45313.0	–	13.00	0.5118	76.0	124.0	45.0	14.00
R45333/64	33/64	13.10	0.5156	76.0	124.0	45.0	14.00
R45313.3	–	13.30	0.5236	76.0	124.0	45.0	14.00
R45317/32	17/32	13.49	0.5313	76.0	124.0	45.0	14.00
R45313.5	–	13.50	0.5315	76.0	124.0	45.0	14.00
R45313.8	–	13.80	0.5433	76.0	124.0	45.0	14.00
R45335/64	35/64	13.89	0.5469	76.0	124.0	45.0	14.00
R45314.0	–	14.00	0.5512	76.0	124.0	45.0	14.00
R45314.25	–	14.25	0.5610	82.0	133.0	48.0	16.00
R4539/16	9/16	14.29	0.5625	82.0	133.0	48.0	16.00
R45314.5	–	14.50	0.5709	82.0	133.0	48.0	16.00
R45337/64	37/64	14.68	0.5781	82.0	133.0	48.0	16.00
R45314.8	–	14.80	0.5827	82.0	133.0	48.0	16.00
R45315.0	–	15.00	0.5906	82.0	133.0	48.0	16.00
R45319/32	19/32	15.08	0.5938	82.0	133.0	48.0	16.00
R45315.1	–	15.10	0.5945	82.0	133.0	48.0	16.00
R45315.3	–	15.30	0.6024	82.0	133.0	48.0	16.00
R45339/64	39/64	15.48	0.6094	82.0	133.0	48.0	16.00
R45315.5	–	15.50	0.6102	82.0	133.0	48.0	16.00
R45315.8	–	15.80	0.6220	82.0	133.0	48.0	16.00
R4535/8	5/8	15.88	0.6250	82.0	133.0	48.0	16.00
R45316.0	–	16.00	0.6299	82.0	133.0	48.0	16.00
R45341/64	41/64	16.27	0.6406	91.0	143.0	48.0	18.00
R45316.5	–	16.50	0.6496	91.0	143.0	48.0	18.00
R45321/32	21/32	16.67	0.6563	91.0	143.0	48.0	18.00
R45317.0	–	17.00	0.6693	91.0	143.0	48.0	18.00
R45343/64	43/64	17.07	0.6720	91.0	143.0	48.0	18.00
R45311/16	11/16	17.46	0.6874	91.0	143.0	48.0	18.00
R45317.5	–	17.50	0.6890	91.0	143.0	48.0	18.00
R45317.8	–	17.80	0.7008	91.0	143.0	48.0	18.00
R45345/64	45/64	17.86	0.7031	91.0	143.0	48.0	18.00
R45318.0	–	18.00	0.7087	91.0	143.0	48.0	18.00
R45323/32	23/32	18.26	0.7189	99.0	143.0	48.0	20.00
R45318.5	–	18.50	0.7283	99.0	153.0	50.0	20.00
R45347/64	47/64	18.65	0.7343	99.0	153.0	50.0	20.00
R45319.0	–	19.00	0.7480	99.0	153.0	50.0	20.00
R4533/4	3/4	19.05	0.7500	99.0	153.0	50.0	20.00
R45319.5	–	19.50	0.7677	99.0	153.0	50.0	20.00
R45319.8	–	19.80	0.7795	99.0	153.0	50.0	20.00
R45320.0	–	20.00	0.7874	99.0	153.0	50.0	20.00



R459



FORCE X Solid Carbide 8XD Drill with Coolant Feed, TiAlN Coated

High performance drill, able to produce high quality and accurate holes at high speeds and feeds (H9 hole tolerance). Self centering 140°, 4-facet split point and CTW flute construction for enhanced penetration rates. Coolant holes to enhance chip evacuation. TiAlN coating increases surface hardness and improves tool life.

FORCE X

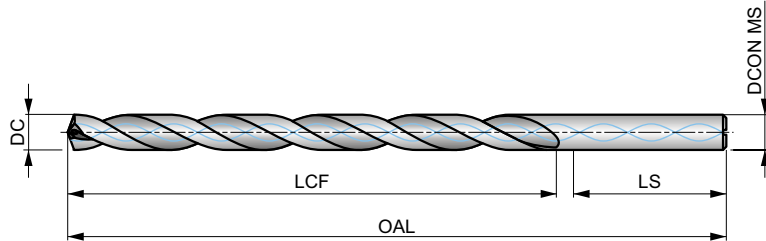

HM	DORMER	8xD
140°	TiAlN	DIN 6535HA
CTW	DC m7	

Workpiece material group suitability, starting values for cutting speed (m/min) and feed Alpha Code. Tables with feed per revolution can be found starting from page 65.

P1.1 ■ 143 V	P1.2 ■ 160 V	P1.3 ■ 166 V	P2.1 ■ 122 V	P2.2 ■ 108 U	P2.3 ■ 95 U	P3.1 ■ 106 U	P3.2 ■ 86 U	P3.3 ■ 72 U	P4.1 ■ 63 U	P4.2 ■ 54 U	P4.3 ■ 44 T	M1.1 ■ 60 V	M1.2 ■ 51 V
M2.1 ■ 154 V	M2.2 ■ 44 V	M2.3 ■ 37 U	M3.1 ■ 33 V	M3.2 ■ 28 V	M3.3 ■ 26 V	M4.1 ■ 24 U	M4.2 ■ 21 U	K1.1 ■ 88 W	K1.2 ■ 65 W	K1.3 ■ 49 W	K2.1 ■ 78 V	K2.2 ■ 64 V	K2.3 ■ 51 V
K3.1 ■ 70 V	K3.2 ■ 54 V	K3.3 ■ 43 V	K4.1 ■ 65 V	K4.2 ■ 49 V	K4.3 ■ 36 V	K4.4 ■ 30 V	K4.5 ■ 26 V	K5.1 ■ 73 V	K5.2 ■ 55 V	K5.3 ■ 42 V	N1.1 ■ 200 W	N1.2 ■ 150 W	N1.3 ■ 100 W
N2.1 ■ 246 V	N2.2 ■ 222 V	N2.3 ■ 160 V	N3.1 ■ 298 V	N3.2 ■ 176 V	N3.3 ■ 188 V								

DCON MS tolerance h6.

Product	DC [inch]	DC [mm]	DC [inch]	LCF [mm]	OAL [mm]	LS [mm]	DCON MS [mm]
R4593.0	–	3.00	0.1181	37.0	79.0	36.0	6.00
R4593.1	–	3.10	0.1220	37.0	79.0	36.0	6.00
R4591/8	1/8	3.18	0.1250	37.0	79.0	36.0	6.00
R4593.2	–	3.20	0.1260	37.0	79.0	36.0	6.00
R4593.3	–	3.30	0.1299	37.0	79.0	36.0	6.00
R4593.4	–	3.40	0.1339	37.0	79.0	36.0	6.00
R4593.5	–	3.50	0.1378	37.0	79.0	36.0	6.00
R4599/64	9/64	3.57	0.1406	37.0	79.0	36.0	6.00
R4593.6	–	3.60	0.1417	37.0	79.0	36.0	6.00
R4593.7	–	3.70	0.1457	37.0	79.0	36.0	6.00
R4593.8	–	3.80	0.1496	48.0	90.0	36.0	6.00
R4593.9	–	3.90	0.1535	48.0	90.0	36.0	6.00
R4595/32	5/32	3.97	0.1563	48.0	90.0	36.0	6.00
R4594.0	–	4.00	0.1575	48.0	90.0	36.0	6.00
R4594.1	–	4.10	0.1614	48.0	90.0	36.0	6.00
R4594.2	–	4.20	0.1654	48.0	90.0	36.0	6.00
R4594.3	–	4.30	0.1693	48.0	90.0	36.0	6.00
R45911/64	11/64	4.37	0.1719	48.0	90.0	36.0	6.00
R4594.4	–	4.40	0.1732	48.0	90.0	36.0	6.00
R4594.5	–	4.50	0.1772	48.0	90.0	36.0	6.00
R4594.6	–	4.60	0.1811	48.0	90.0	36.0	6.00
R4594.7	–	4.70	0.1850	62.0	104.0	36.0	6.00
R4593/16	3/16	4.76	0.1875	62.0	104.0	36.0	6.00
R4594.8	–	4.80	0.1890	62.0	104.0	36.0	6.00
R4594.9	–	4.90	0.1929	62.0	104.0	36.0	6.00



Product	DC	DC	DC	LCF	OAL	LS	DCON MS
	[inch]	[mm]	[inch]	[mm]	[mm]	[mm]	[mm]
R4595.0	–	5.00	0.1969	62.0	104.0	36.0	6.00
R4595.1	–	5.10	0.2008	62.0	104.0	36.0	6.00
R45913/64	13/64	5.16	0.2031	62.0	104.0	36.0	6.00
R4595.2	–	5.20	0.2047	62.0	104.0	36.0	6.00
R4595.3	–	5.30	0.2087	62.0	104.0	36.0	6.00
R4595.4	–	5.40	0.2126	62.0	104.0	36.0	6.00
R4595.5	–	5.50	0.2165	62.0	104.0	36.0	6.00
R4597/32	7/32	5.56	0.2188	62.0	104.0	36.0	6.00
R4595.6	–	5.60	0.2205	62.0	104.0	36.0	6.00
R4595.7	–	5.70	0.2244	62.0	104.0	36.0	6.00
R4595.8	–	5.80	0.2283	62.0	104.0	36.0	6.00
R4595.9	–	5.90	0.2323	62.0	104.0	36.0	6.00
R45915/64	15/64	5.95	0.2344	62.0	104.0	36.0	6.00
R4596.0	–	6.00	0.2362	62.0	104.0	36.0	6.00
R4596.1	–	6.10	0.2402	84.0	126.0	36.0	8.00
R4596.2	–	6.20	0.2441	84.0	126.0	36.0	8.00
R4596.3	–	6.30	0.2480	84.0	126.0	36.0	8.00
R4591/4	1/4	6.35	0.2500	84.0	126.0	36.0	8.00
R4596.4	–	6.40	0.2520	84.0	126.0	36.0	8.00
R4596.5	–	6.50	0.2559	84.0	126.0	36.0	8.00
R4596.6	–	6.60	0.2598	84.0	126.0	36.0	8.00
R4596.7	–	6.70	0.2638	84.0	126.0	36.0	8.00
R45917/64	17/64	6.75	0.2656	84.0	126.0	36.0	8.00
R4596.8	–	6.80	0.2677	84.0	126.0	36.0	8.00
R4596.9	–	6.90	0.2717	84.0	126.0	36.0	8.00
R4597.0	–	7.00	0.2756	84.0	126.0	36.0	8.00
R4597.1	–	7.10	0.2795	84.0	126.0	36.0	8.00
R4599/32	9/32	7.14	0.2813	84.0	126.0	36.0	8.00
R4597.2	–	7.20	0.2835	84.0	126.0	36.0	8.00
R4597.3	–	7.30	0.2874	84.0	126.0	36.0	8.00
R4597.4	–	7.40	0.2913	84.0	126.0	36.0	8.00
R4597.5	–	7.50	0.2953	84.0	126.0	36.0	8.00
R45919/64	19/64	7.54	0.2969	84.0	126.0	36.0	8.00
R4597.6	–	7.60	0.2992	84.0	126.0	36.0	8.00
R4597.7	–	7.70	0.3031	84.0	126.0	36.0	8.00
R4597.8	–	7.80	0.3071	84.0	126.0	36.0	8.00
R4597.9	–	7.90	0.3110	84.0	126.0	36.0	8.00
R4595/16	5/16	7.94	0.3125	84.0	126.0	36.0	8.00
R4598.0	–	8.00	0.3150	84.0	126.0	36.0	8.00
R4598.1	–	8.10	0.3189	106.0	152.0	40.0	10.00
R4598.2	–	8.20	0.3228	106.0	152.0	40.0	10.00
R4598.3	–	8.30	0.3268	106.0	152.0	40.0	10.00
R45921/64	21/64	8.33	0.3281	106.0	152.0	40.0	10.00
R4598.4	–	8.40	0.3307	106.0	152.0	40.0	10.00
R4598.5	–	8.50	0.3346	106.0	152.0	40.0	10.00
R4598.6	–	8.60	0.3386	106.0	152.0	40.0	10.00
R4598.7	–	8.70	0.3425	106.0	152.0	40.0	10.00
R45911/32	11/32	8.73	0.3438	106.0	152.0	40.0	10.00
R4598.8	–	8.80	0.3465	106.0	152.0	40.0	10.00
R4598.9	–	8.90	0.3504	106.0	152.0	40.0	10.00
R4599.0	–	9.00	0.3543	106.0	152.0	40.0	10.00
R4599.1	–	9.10	0.3583	106.0	152.0	40.0	10.00
R45923/64	23/64	9.13	0.3594	106.0	152.0	40.0	10.00
R4599.2	–	9.20	0.3622	106.0	152.0	40.0	10.00
R4599.3	–	9.30	0.3661	106.0	152.0	40.0	10.00
R4599.4	–	9.40	0.3701	106.0	152.0	40.0	10.00
R4599.5	–	9.50	0.3740	106.0	152.0	40.0	10.00
R4593/8	3/8	9.53	0.3750	106.0	152.0	40.0	10.00
R4599.6	–	9.60	0.3780	106.0	152.0	40.0	10.00
R4599.7	–	9.70	0.3819	106.0	152.0	40.0	10.00
R4599.8	–	9.80	0.3858	106.0	152.0	40.0	10.00
R4599.9	–	9.90	0.3898	106.0	152.0	40.0	10.00



Product	DC	DC	DC	LCF	OAL	LS	DCON MS
	[inch]	[mm]	[inch]	[mm]	[mm]	[mm]	[mm]
R45925/64	25/64	9.92	0.3906	106.0	152.0	40.0	10.00
R45910.0	–	10.00	0.3937	106.0	152.0	40.0	10.00
R45910.2	–	10.20	0.4016	128.0	180.0	45.0	12.00
R45910.3	–	10.30	0.4055	128.0	180.0	45.0	12.00
R45913/32	13/32	10.32	0.4063	128.0	180.0	45.0	12.00
R45910.4	–	10.40	0.4094	128.0	180.0	45.0	12.00
R45910.5	–	10.50	0.4134	128.0	180.0	45.0	12.00
R45927/64	27/64	10.72	0.4219	128.0	180.0	45.0	12.00
R45910.8	–	10.80	0.4252	128.0	180.0	45.0	12.00
R45911.0	–	11.00	0.4331	128.0	180.0	45.0	12.00
R4597/16	7/16	11.11	0.4375	128.0	180.0	45.0	12.00
R45911.2	–	11.20	0.4409	128.0	180.0	45.0	12.00
R45911.3	–	11.30	0.4449	128.0	180.0	45.0	12.00
R45911.5	–	11.50	0.4528	128.0	180.0	45.0	12.00
R45929/64	29/64	11.51	0.4531	128.0	180.0	45.0	12.00
R45911.8	–	11.80	0.4646	128.0	180.0	45.0	12.00
R45915/32	15/32	11.91	0.4688	128.0	180.0	45.0	12.00
R45912.0	–	12.00	0.4724	128.0	180.0	45.0	12.00
R45912.2	–	12.20	0.4803	151.0	202.0	48.0	14.00
R45931/64	31/64	12.30	0.4844	151.0	202.0	48.0	14.00
R45912.5	–	12.50	0.4921	151.0	202.0	48.0	14.00
R4591/2	1/2	12.70	0.5000	151.0	202.0	48.0	14.00
R45912.8	–	12.80	0.5039	151.0	202.0	48.0	14.00
R45913.0	–	13.00	0.5118	151.0	202.0	48.0	14.00
R45933/64	33/64	13.10	0.5156	151.0	202.0	48.0	14.00
R45917/32	17/32	13.49	0.5313	151.0	202.0	48.0	14.00
R45913.5	–	13.50	0.5315	151.0	202.0	48.0	14.00
R45935/64	35/64	13.89	0.5469	151.0	202.0	48.0	14.00
R45914.0	–	14.00	0.5512	151.0	202.0	48.0	14.00
R45914.25	–	14.25	0.5610	172.0	227.0	48.0	16.00
R4599/16	9/16	14.29	0.5625	172.0	227.0	48.0	16.00
R45914.5	–	14.50	0.5709	172.0	227.0	48.0	16.00
R45937/64	37/64	14.68	0.5781	172.0	227.0	48.0	16.00
R45915.0	–	15.00	0.5906	172.0	227.0	48.0	16.00
R45919/32	19/32	15.08	0.5938	172.0	227.0	48.0	16.00
R45915.1	–	15.10	0.5945	172.0	227.0	48.0	16.00
R45939/64	39/64	15.48	0.6094	172.0	227.0	48.0	16.00
R45915.5	–	15.50	0.6102	172.0	227.0	48.0	16.00
R4595/8	5/8	15.88	0.6250	172.0	227.0	48.0	16.00
R45916.0	–	16.00	0.6299	172.0	227.0	48.0	16.00



R467



FORCE M Solid Carbide 3XD Drill with Coolant Feed, TiAIN Coated

High performance drill, able to produce high quality and accurate holes at high speeds and feeds (H9 hole tolerance in stainless steel and heat resistant materials). A 140°, 4-facet split point and CTW flute construction. Coolant holes enhance chip evacuation. TiAIN coating increases surface hardness and improves tool life.

FORCE M

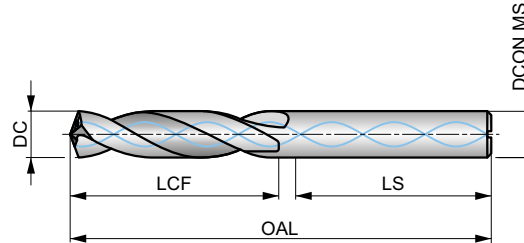

HM	DIN 6537K	3xD
140°	TiAIN	DIN 6535HA
GTW	DC m7	

Workpiece material group suitability, starting values for cutting speed (m/min) and feed Alpha Code. Tables with feed per revolution can be found starting from page 65.

M1.1 ■ 117 G	M1.2 ■ 99 G	M2.1 ■ 104 G	M2.2 ■ 85 G	M2.3 ■ 71 E	M3.1 ■ 87 G	M3.2 ■ 75 G	M3.3 ■ 68 F	M4.1 ■ 60 F	M4.2 ■ 52 E	S1.1 ■ 55 V	S1.2 ■ 45 V	S1.3 ■ 40 U	S2.1 ■ 60 U
S2.2 ■ 56 U	S3.1 ■ 45 U	S3.2 ■ 40 U	S4.1 ■ 35 U	S4.2 ■ 32 U									

DCON MS tolerance h6.

Product	DC [inch]	DC [mm]	DC [inch]	LCF [mm]	OAL [mm]	LS [mm]	DCON MS [mm]
R4673.0	–	3.00	0.1181	20.0	62.0	36.0	6.00
R4673.1	–	3.10	0.1220	20.0	62.0	36.0	6.00
R4671/8	1/8	3.18	0.1250	20.0	62.0	36.0	6.00
R4673.2	–	3.20	0.1260	20.0	62.0	36.0	6.00
R4673.3	–	3.30	0.1299	20.0	62.0	36.0	6.00
R4673.4	–	3.40	0.1339	20.0	62.0	36.0	6.00
R467N29	N29	3.45	0.1360	20.0	62.0	36.0	6.00
R4673.5	–	3.50	0.1378	20.0	62.0	36.0	6.00
R4679/64	9/64	3.57	0.1406	20.0	62.0	36.0	6.00
R4673.6	–	3.60	0.1417	20.0	62.0	36.0	6.00
R4673.7	–	3.70	0.1457	20.0	62.0	36.0	6.00
R4673.8	–	3.80	0.1496	24.0	66.0	36.0	6.00
R4673.9	–	3.90	0.1535	24.0	66.0	36.0	6.00
R4675/32	5/32	3.97	0.1563	24.0	66.0	36.0	6.00
R4674.0	–	4.00	0.1575	24.0	66.0	36.0	6.00
R4674.05	–	4.05	0.1594	24.0	66.0	36.0	6.00
R4674.1	–	4.10	0.1614	24.0	66.0	36.0	6.00
R4674.2	–	4.20	0.1654	24.0	66.0	36.0	6.00
R4674.3	–	4.30	0.1693	24.0	66.0	36.0	6.00
R46711/64	11/64	4.37	0.1719	24.0	66.0	36.0	6.00
R4674.4	–	4.40	0.1732	24.0	66.0	36.0	6.00
R4674.5	–	4.50	0.1772	24.0	66.0	36.0	6.00
R4674.6	–	4.60	0.1811	24.0	66.0	36.0	6.00
R4674.7	–	4.70	0.1850	24.0	66.0	36.0	6.00
R4673/16	3/16	4.76	0.1875	28.0	66.0	36.0	6.00
R4674.8	–	4.80	0.1890	28.0	66.0	36.0	6.00
R4674.9	–	4.90	0.1929	28.0	66.0	36.0	6.00
R4675.0	–	5.00	0.1969	28.0	66.0	36.0	6.00
R4675.05	–	5.05	0.1988	28.0	66.0	36.0	6.00



Product	DC	DC	DC	LCF	OAL	LS	DCON MS
	[inch]	[mm]	[inch]	[mm]	[mm]	[mm]	[mm]
R4675.1	—	5.10	0.2008	28.0	66.0	36.0	6.00
R467N7	N7	5.11	0.2010	28.0	66.0	36.0	6.00
R46713/64	13/64	5.16	0.2031	28.0	66.0	36.0	6.00
R4675.2	—	5.20	0.2047	28.0	66.0	36.0	6.00
R467N5	N5	5.22	0.2055	28.0	66.0	36.0	6.00
R4675.3	—	5.30	0.2087	28.0	66.0	36.0	6.00
R4675.4	—	5.40	0.2126	28.0	66.0	36.0	6.00
R4675.5	—	5.50	0.2165	28.0	66.0	36.0	6.00
R4677/32	7/32	5.56	0.2188	28.0	66.0	36.0	6.00
R4675.6	—	5.60	0.2205	28.0	66.0	36.0	6.00
R4675.7	—	5.70	0.2244	28.0	66.0	36.0	6.00
R4675.8	—	5.80	0.2283	28.0	66.0	36.0	6.00
R4675.9	—	5.90	0.2323	28.0	66.0	36.0	6.00
R46715/64	15/64	5.95	0.2344	28.0	66.0	36.0	6.00
R4676.0	—	6.00	0.2362	28.0	66.0	36.0	6.00
R4676.05	—	6.05	0.2382	34.0	79.0	36.0	8.00
R4676.1	—	6.10	0.2402	34.0	79.0	36.0	8.00
R4676.2	—	6.20	0.2441	34.0	79.0	36.0	8.00
R4676.3	—	6.30	0.2480	34.0	79.0	36.0	8.00
R4671/4	1/4	6.35	0.2500	34.0	79.0	36.0	8.00
R4676.4	—	6.40	0.2520	34.0	79.0	36.0	8.00
R4676.5	—	6.50	0.2559	34.0	79.0	36.0	8.00
R4676.6	—	6.60	0.2598	34.0	79.0	36.0	8.00
R4676.7	—	6.70	0.2638	34.0	79.0	36.0	8.00
R46717/64	17/64	6.75	0.2656	34.0	79.0	36.0	8.00
R4676.8	—	6.80	0.2677	34.0	79.0	36.0	8.00
R4676.9	—	6.90	0.2717	34.0	79.0	36.0	8.00
R4677.0	—	7.00	0.2756	34.0	79.0	36.0	8.00
R4677.1	—	7.10	0.2795	41.0	79.0	36.0	8.00
R4679/32	9/32	7.14	0.2813	41.0	79.0	36.0	8.00
R4677.2	—	7.20	0.2835	41.0	79.0	36.0	8.00
R4677.3	—	7.30	0.2874	41.0	79.0	36.0	8.00
R4677.4	—	7.40	0.2913	41.0	79.0	36.0	8.00
R4677.5	—	7.50	0.2953	41.0	79.0	36.0	8.00
R46719/64	19/64	7.54	0.2969	41.0	79.0	36.0	8.00
R4677.6	—	7.60	0.2992	41.0	79.0	36.0	8.00
R4677.7	—	7.70	0.3031	41.0	79.0	36.0	8.00
R4677.8	—	7.80	0.3071	41.0	79.0	36.0	8.00
R4677.9	—	7.90	0.3110	41.0	79.0	36.0	8.00
R4675/16	5/16	7.94	0.3125	41.0	79.0	36.0	8.00
R4678.0	—	8.00	0.3150	41.0	79.0	36.0	8.00
R4678.05	—	8.05	0.3169	47.0	89.0	40.0	10.00
R4678.1	—	8.10	0.3189	47.0	89.0	40.0	10.00
R4678.2	—	8.20	0.3228	47.0	89.0	40.0	10.00
R4678.3	—	8.30	0.3268	47.0	89.0	40.0	10.00
R46721/64	21/64	8.33	0.3281	47.0	89.0	40.0	10.00
R4678.4	—	8.40	0.3307	47.0	89.0	40.0	10.00
R4678.5	—	8.50	0.3346	47.0	89.0	40.0	10.00
R4678.6	—	8.60	0.3386	47.0	89.0	40.0	10.00
R4678.7	—	8.70	0.3425	47.0	89.0	40.0	10.00
R46711/32	11/32	8.73	0.3438	47.0	89.0	40.0	10.00
R4678.8	—	8.80	0.3465	47.0	89.0	40.0	10.00
R4678.9	—	8.90	0.3504	47.0	89.0	40.0	10.00
R4679.0	—	9.00	0.3543	47.0	89.0	40.0	10.00
R4679.1	—	9.10	0.3583	47.0	89.0	40.0	10.00
R46723/64	23/64	9.13	0.3594	47.0	89.0	40.0	10.00
R4679.2	—	9.20	0.3622	47.0	89.0	40.0	10.00
R4679.3	—	9.30	0.3661	47.0	89.0	40.0	10.00
R4679.4	—	9.40	0.3701	47.0	89.0	40.0	10.00
R4679.5	—	9.50	0.3740	47.0	89.0	40.0	10.00
R4673/8	3/8	9.53	0.3750	47.0	89.0	40.0	10.00
R4679.6	—	9.60	0.3780	47.0	89.0	40.0	10.00



Product	DC	DC	DC	LCF	OAL	LS	DCON MS
	[inch]	[mm]	[inch]	[mm]	[mm]	[mm]	[mm]
R4679.7	–	9.70	0.3819	47.0	89.0	40.0	10.00
R4679.8	–	9.80	0.3858	47.0	89.0	40.0	10.00
R4679.9	–	9.90	0.3898	47.0	89.0	40.0	10.00
R46725/64	25/64	9.92	0.3906	47.0	89.0	40.0	10.00
R46710.0	–	10.00	0.3937	47.0	89.0	40.0	10.00
R46710.05	–	10.05	0.3957	55.0	102.0	45.0	12.00
R46710.1	–	10.10	0.3976	55.0	102.0	45.0	12.00
R46710.2	–	10.20	0.4016	55.0	102.0	45.0	12.00
R46710.3	–	10.30	0.4055	55.0	102.0	45.0	12.00
R46713/32	13/32	10.32	0.4063	55.0	102.0	45.0	12.00
R46710.4	–	10.40	0.4094	55.0	102.0	45.0	12.00
R46710.5	–	10.50	0.4134	55.0	102.0	45.0	12.00
R46710.6	–	10.60	0.4173	55.0	102.0	45.0	12.00
R46727/64	27/64	10.72	0.4219	55.0	102.0	45.0	12.00
R46710.8	–	10.80	0.4252	55.0	102.0	45.0	12.00
R46710.9	–	10.90	0.4291	55.0	102.0	45.0	12.00
R46711.0	–	11.00	0.4331	55.0	102.0	45.0	12.00
R4677/16	7/16	11.11	0.4375	55.0	102.0	45.0	12.00
R46711.2	–	11.20	0.4409	55.0	102.0	45.0	12.00
R46711.3	–	11.30	0.4449	55.0	102.0	45.0	12.00
R46711.4	–	11.40	0.4488	55.0	102.0	45.0	12.00
R46711.5	–	11.50	0.4528	55.0	102.0	45.0	12.00
R46729/64	29/64	11.51	0.4531	55.0	102.0	45.0	12.00
R46711.6	–	11.60	0.4567	55.0	102.0	45.0	12.00
R46711.8	–	11.80	0.4646	55.0	102.0	45.0	12.00
R46715/32	15/32	11.91	0.4688	55.0	102.0	45.0	12.00
R46712.0	–	12.00	0.4724	55.0	102.0	45.0	12.00
R46712.05	–	12.05	0.4744	60.0	107.0	45.0	14.00
R46712.1	–	12.10	0.4764	60.0	107.0	45.0	14.00
R46712.2	–	12.20	0.4803	60.0	107.0	45.0	14.00
R46731/64	31/64	12.30	0.4844	60.0	107.0	45.0	14.00
R46712.5	–	12.50	0.4921	60.0	107.0	45.0	14.00
R46712.7	–	12.70	0.5000	60.0	107.0	45.0	14.00
R4671/2	1/2	12.70	0.5000	60.0	107.0	45.0	14.00
R46712.8	–	12.80	0.5039	60.0	107.0	45.0	14.00
R46713.0	–	13.00	0.5118	60.0	107.0	45.0	14.00
R46733/64	33/64	13.10	0.5156	60.0	107.0	45.0	14.00
R46713.3	–	13.30	0.5236	60.0	107.0	45.0	14.00
R46717/32	17/32	13.49	0.5313	60.0	107.0	45.0	14.00
R46713.5	–	13.50	0.5315	60.0	107.0	45.0	14.00
R46713.8	–	13.80	0.5433	60.0	107.0	45.0	14.00
R46735/64	35/64	13.89	0.5469	60.0	107.0	45.0	14.00
R46714.0	–	14.00	0.5512	60.0	107.0	45.0	14.00
R46714.25	–	14.25	0.5610	65.0	115.0	48.0	16.00
R4679/16	9/16	14.29	0.5625	65.0	115.0	48.0	16.00
R46714.5	–	14.50	0.5709	65.0	115.0	48.0	16.00
R46737/64	37/64	14.68	0.5781	65.0	115.0	48.0	16.00
R46714.8	–	14.80	0.5827	65.0	115.0	48.0	16.00
R46715.0	–	15.00	0.5906	65.0	115.0	48.0	16.00
R46719/32	19/32	15.08	0.5938	65.0	115.0	48.0	16.00
R46715.1	–	15.10	0.5945	65.0	115.0	48.0	16.00
R46715.3	–	15.30	0.6024	65.0	115.0	48.0	16.00
R46739/64	39/64	15.48	0.6094	65.0	115.0	48.0	16.00
R46715.5	–	15.50	0.6102	65.0	115.0	48.0	16.00
R46715.8	–	15.80	0.6220	65.0	115.0	48.0	16.00
R4675/8	5/8	15.88	0.6250	65.0	115.0	48.0	16.00
R46716.0	–	16.00	0.6299	65.0	115.0	48.0	16.00



R463



FORCE M Solid Carbide 5XD Drill with Coolant Feed. TiAlN Coated

High performance drill, able to produce high quality and accurate holes at high speeds and feeds (H9 hole tolerance in stainless steel and heat resistant materials). A 140°, 4-facet split point and CTW flute construction. Coolant holes enhance chip evacuation. TiAlN coating increases surface hardness and improves tool life.

FORCE M

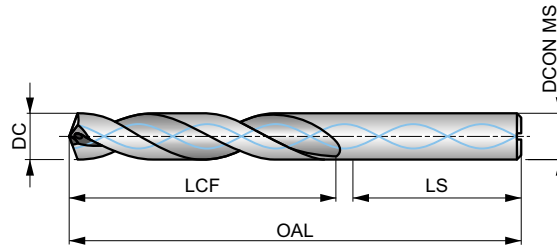

HM	DIN 6537L	5xD
140°	TiAlN	DIN 6535HA
CTW	DC m7	

Workpiece material group suitability, starting values for cutting speed (m/min) and feed Alpha Code. Tables with feed per revolution can be found starting from page 65.

M1.1 ■ 111 G	M1.2 ■ 94 G	M2.1 ■ 99 G	M2.2 ■ 81 G	M2.3 ■ 67 E	M3.1 ■ 83 G	M3.2 ■ 71 G	M3.3 ■ 65 F	M4.1 ■ 57 F	M4.2 ■ 49 E	S1.1 ■ 52 V	S1.2 ■ 43 V	S1.3 ■ 38 U	S2.1 ■ 57 U
S2.2 ■ 53 U	S3.1 ■ 43 U	S3.2 ■ 38 U	S4.1 ■ 33 U	S4.2 ■ 30 U									

DCON MS tolerance h6.

Product	DC [inch]	DC [mm]	DC [inch]	LCF [mm]	OAL [mm]	LS [mm]	DCON MS [mm]
R4633.0	–	3.00	0.1181	28.0	66.0	36.0	6.00
R4633.1	–	3.10	0.1220	28.0	66.0	36.0	6.00
R4631/8	1/8	3.18	0.1250	28.0	66.0	36.0	6.00
R4633.2	–	3.20	0.1260	28.0	66.0	36.0	6.00
R4633.3	–	3.30	0.1299	28.0	66.0	36.0	6.00
R4633.4	–	3.40	0.1339	28.0	66.0	36.0	6.00
R463N29	N29	3.45	0.1360	28.0	66.0	36.0	6.00
R4633.5	–	3.50	0.1378	28.0	66.0	36.0	6.00
R4639/64	9/64	3.57	0.1406	28.0	66.0	36.0	6.00
R4633.6	–	3.60	0.1417	28.0	66.0	36.0	6.00
R4633.7	–	3.70	0.1457	28.0	66.0	36.0	6.00
R4633.8	–	3.80	0.1496	36.0	74.0	36.0	6.00
R4633.9	–	3.90	0.1535	36.0	74.0	36.0	6.00
R4635/32	5/32	3.97	0.1563	36.0	74.0	36.0	6.00
R4634.0	–	4.00	0.1575	36.0	74.0	36.0	6.00
R4634.05	–	4.05	0.1594	36.0	74.0	36.0	6.00
R4634.1	–	4.10	0.1614	36.0	74.0	36.0	6.00
R4634.2	–	4.20	0.1654	36.0	74.0	36.0	6.00
R4634.3	–	4.30	0.1693	36.0	74.0	36.0	6.00
R46311/64	11/64	4.37	0.1719	36.0	74.0	36.0	6.00
R4634.4	–	4.40	0.1732	36.0	74.0	36.0	6.00
R4634.5	–	4.50	0.1772	36.0	74.0	36.0	6.00
R4634.6	–	4.60	0.1811	36.0	74.0	36.0	6.00
R4634.7	–	4.70	0.1850	36.0	74.0	36.0	6.00
R4633/16	3/16	4.76	0.1875	44.0	82.0	36.0	6.00
R4634.8	–	4.80	0.1890	44.0	82.0	36.0	6.00
R4634.9	–	4.90	0.1929	44.0	82.0	36.0	6.00
R4635.0	–	5.00	0.1969	44.0	82.0	36.0	6.00
R4635.05	–	5.05	0.1988	44.0	82.0	36.0	6.00



Product	DC	DC	DC	LCF	OAL	LS	DCON MS
	[inch]	[mm]	[inch]	[mm]	[mm]	[mm]	[mm]
R4635.1	–	5.10	0.2008	44.0	82.0	36.0	6.00
R463N7	N7	5.11	0.2010	44.0	82.0	36.0	6.00
R46313/64	13/64	5.16	0.2031	44.0	82.0	36.0	6.00
R4635.2	–	5.20	0.2047	44.0	82.0	36.0	6.00
R463N5	N5	5.22	0.2055	44.0	82.0	36.0	6.00
R4635.3	–	5.30	0.2087	44.0	82.0	36.0	6.00
R4635.4	–	5.40	0.2126	44.0	82.0	36.0	6.00
R4635.5	–	5.50	0.2165	44.0	82.0	36.0	6.00
R4637/32	7/32	5.56	0.2188	44.0	82.0	36.0	6.00
R4635.6	–	5.60	0.2205	44.0	82.0	36.0	6.00
R4635.7	–	5.70	0.2244	44.0	82.0	36.0	6.00
R4635.8	–	5.80	0.2283	44.0	82.0	36.0	6.00
R4635.9	–	5.90	0.2323	44.0	82.0	36.0	6.00
R46315/64	15/64	5.95	0.2344	44.0	82.0	36.0	6.00
R4636.0	–	6.00	0.2362	44.0	82.0	36.0	6.00
R4636.05	–	6.05	0.2382	53.0	91.0	36.0	8.00
R4636.1	–	6.10	0.2402	53.0	91.0	36.0	8.00
R4636.2	–	6.20	0.2441	53.0	91.0	36.0	8.00
R4636.3	–	6.30	0.2480	53.0	91.0	36.0	8.00
R4631/4	1/4	6.35	0.2500	53.0	91.0	36.0	8.00
R4636.4	–	6.40	0.2520	53.0	91.0	36.0	8.00
R4636.5	–	6.50	0.2559	53.0	91.0	36.0	8.00
R4636.6	–	6.60	0.2598	53.0	91.0	36.0	8.00
R4636.7	–	6.70	0.2638	53.0	91.0	36.0	8.00
R46317/64	17/64	6.75	0.2656	53.0	91.0	36.0	8.00
R4636.8	–	6.80	0.2677	53.0	91.0	36.0	8.00
R4636.9	–	6.90	0.2717	53.0	91.0	36.0	8.00
R4637.0	–	7.00	0.2756	53.0	91.0	36.0	8.00
R4637.1	–	7.10	0.2795	53.0	91.0	36.0	8.00
R4639/32	9/32	7.14	0.2813	53.0	91.0	36.0	8.00
R4637.2	–	7.20	0.2835	53.0	91.0	36.0	8.00
R4637.3	–	7.30	0.2874	53.0	91.0	36.0	8.00
R4637.4	–	7.40	0.2913	53.0	91.0	36.0	8.00
R4637.5	–	7.50	0.2953	53.0	91.0	36.0	8.00
R46319/64	19/64	7.54	0.2969	53.0	91.0	36.0	8.00
R4637.6	–	7.60	0.2992	53.0	91.0	36.0	8.00
R4637.7	–	7.70	0.3031	53.0	91.0	36.0	8.00
R4637.8	–	7.80	0.3071	53.0	91.0	36.0	8.00
R4637.9	–	7.90	0.3110	53.0	91.0	36.0	8.00
R4635/16	5/16	7.94	0.3125	53.0	91.0	36.0	8.00
R4638.0	–	8.00	0.3150	53.0	91.0	36.0	8.00
R4638.05	–	8.05	0.3169	61.0	103.0	40.0	10.00
R4638.1	–	8.10	0.3189	61.0	103.0	40.0	10.00
R4638.2	–	8.20	0.3228	61.0	103.0	40.0	10.00
R4638.3	–	8.30	0.3268	61.0	103.0	40.0	10.00
R46321/64	21/64	8.33	0.3281	61.0	103.0	40.0	10.00
R4638.4	–	8.40	0.3307	61.0	103.0	40.0	10.00
R4638.5	–	8.50	0.3346	61.0	103.0	40.0	10.00
R4638.6	–	8.60	0.3386	61.0	103.0	40.0	10.00
R4638.7	–	8.70	0.3425	61.0	103.0	40.0	10.00
R46311/32	11/32	8.73	0.3438	61.0	103.0	40.0	10.00
R4638.8	–	8.80	0.3465	61.0	103.0	40.0	10.00
R4638.9	–	8.90	0.3504	61.0	103.0	40.0	10.00
R4639.0	–	9.00	0.3543	61.0	103.0	40.0	10.00
R4639.1	–	9.10	0.3583	61.0	103.0	40.0	10.00
R46323/64	23/64	9.13	0.3594	61.0	103.0	40.0	10.00
R4639.2	–	9.20	0.3622	61.0	103.0	40.0	10.00
R4639.3	–	9.30	0.3661	61.0	103.0	40.0	10.00
R4639.4	–	9.40	0.3701	61.0	103.0	40.0	10.00
R4639.5	–	9.50	0.3740	61.0	103.0	40.0	10.00
R4633/8	3/8	9.53	0.3750	61.0	103.0	40.0	10.00
R4639.6	–	9.60	0.3780	61.0	103.0	40.0	10.00



Product	DC	DC	DC	LCF	OAL	LS	DCON MS
	[inch]	[mm]	[inch]	[mm]	[mm]	[mm]	[mm]
R4639.7	–	9.70	0.3819	61.0	103.0	40.0	10.00
R4639.8	–	9.80	0.3858	61.0	103.0	40.0	10.00
R4639.9	–	9.90	0.3898	61.0	103.0	40.0	10.00
R46325/64	25/64	9.92	0.3906	61.0	103.0	40.0	10.00
R46310.0	–	10.00	0.3937	61.0	103.0	40.0	10.00
R46310.05	–	10.05	0.3957	70.0	118.0	45.0	12.00
R46310.1	–	10.10	0.3976	70.0	118.0	45.0	12.00
R46310.2	–	10.20	0.4016	70.0	118.0	45.0	12.00
R46310.3	–	10.30	0.4055	70.0	118.0	45.0	12.00
R46313/32	13/32	10.32	0.4063	70.0	118.0	45.0	12.00
R46310.4	–	10.40	0.4094	70.0	118.0	45.0	12.00
R46310.5	–	10.50	0.4134	70.0	118.0	45.0	12.00
R46310.6	–	10.60	0.4173	70.0	118.0	45.0	12.00
R46327/64	27/64	10.72	0.4219	70.0	118.0	45.0	12.00
R46310.8	–	10.80	0.4252	70.0	118.0	45.0	12.00
R46310.9	–	10.90	0.4291	70.0	118.0	45.0	12.00
R46311.0	–	11.00	0.4331	70.0	118.0	45.0	12.00
R4637/16	7/16	11.11	0.4375	70.0	118.0	45.0	12.00
R46311.2	–	11.20	0.4409	70.0	118.0	45.0	12.00
R46311.3	–	11.30	0.4449	70.0	118.0	45.0	12.00
R46311.4	–	11.40	0.4488	70.0	118.0	45.0	12.00
R46311.5	–	11.50	0.4528	70.0	118.0	45.0	12.00
R46329/64	29/64	11.51	0.4531	70.0	118.0	45.0	12.00
R46311.6	–	11.60	0.4567	70.0	118.0	45.0	12.00
R46311.8	–	11.80	0.4646	70.0	118.0	45.0	12.00
R46315/32	15/32	11.91	0.4688	70.0	118.0	45.0	12.00
R46312.0	–	12.00	0.4724	70.0	118.0	45.0	12.00
R46312.05	–	12.05	0.4744	76.0	124.0	45.0	14.00
R46312.2	–	12.20	0.4803	76.0	124.0	45.0	14.00
R46331/64	31/64	12.30	0.4844	76.0	124.0	45.0	14.00
R46312.5	–	12.50	0.4921	76.0	124.0	45.0	14.00
R46312.7	–	12.70	0.5000	76.0	124.0	45.0	14.00
R4631/2	1/2	12.70	0.5000	76.0	124.0	45.0	14.00
R46312.8	–	12.80	0.5039	76.0	124.0	45.0	14.00
R46313.0	–	13.00	0.5118	76.0	124.0	45.0	14.00
R46333/64	33/64	13.10	0.5156	76.0	124.0	45.0	14.00
R46313.3	–	13.30	0.5236	76.0	124.0	45.0	14.00
R46317/32	17/32	13.49	0.5313	76.0	124.0	45.0	14.00
R46313.5	–	13.50	0.5315	76.0	124.0	45.0	14.00
R46313.8	–	13.80	0.5433	76.0	124.0	45.0	14.00
R46335/64	35/64	13.89	0.5469	76.0	124.0	45.0	14.00
R46314.0	–	14.00	0.5512	76.0	124.0	45.0	14.00
R46314.25	–	14.25	0.5610	82.0	133.0	48.0	16.00
R4639/16	9/16	14.29	0.5625	82.0	133.0	48.0	16.00
R46314.5	–	14.50	0.5709	82.0	133.0	48.0	16.00
R46337/64	37/64	14.68	0.5781	82.0	133.0	48.0	16.00
R46314.8	–	14.80	0.5827	82.0	133.0	48.0	16.00
R46315.0	–	15.00	0.5906	82.0	133.0	48.0	16.00
R46319/32	19/32	15.08	0.5938	82.0	133.0	48.0	16.00
R46315.1	–	15.10	0.5945	82.0	133.0	48.0	16.00
R46315.3	–	15.30	0.6024	82.0	133.0	48.0	16.00
R46339/64	39/64	15.48	0.6094	82.0	133.0	48.0	16.00
R46315.5	–	15.50	0.6102	82.0	133.0	48.0	16.00
R46315.8	–	15.80	0.6220	82.0	133.0	48.0	16.00
R4635/8	5/8	15.88	0.6250	82.0	133.0	48.0	16.00
R46316.0	–	16.00	0.6299	82.0	133.0	48.0	16.00



DRILLING FEED RATE CHART

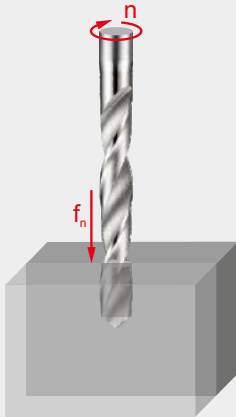

Feed per revolution (f_n in mm/rev)
Depending on the working conditions
it might be necessary to adjust these
values $\pm 25\%$.

How to use this table to find the feed per revolution (f_n):

1. Find your Alpha Code on the product page (example: 46), "J" is the Alpha Code).
2. Find the closest diameter for your cutting application in the top row of the table.
3. Find your Alpha Code in the left column of the table.
4. The intersection (cell) of the Diameter and Alpha Code is the feed per revolution (f_n).

		\varnothing DC [mm]																		
		0.15	0.50	1.00	2.00	3.00	4.00	5.00	6.00	8.00	10.00	12.00	15.00	16.00	20.00	25.00	30.00	40.00	50.00	100.00
Feed rates	A	0.003	0.006	0.012	0.023	0.029	0.032	0.036	0.042	0.054	0.062	0.069	0.082	0.086	0.110	0.125	0.135	0.155	0.175	0.263
	B	0.004	0.007	0.014	0.028	0.037	0.041	0.046	0.053	0.067	0.080	0.090	0.103	0.108	0.135	0.153	0.165	0.188	0.208	0.312
	C	0.004	0.008	0.015	0.032	0.044	0.050	0.056	0.064	0.080	0.098	0.110	0.125	0.130	0.160	0.180	0.195	0.220	0.240	0.360
	D	0.004	0.008	0.016	0.038	0.053	0.060	0.068	0.078	0.098	0.119	0.130	0.149	0.155	0.188	0.210	0.228	0.253	0.275	0.413
	E	0.004	0.009	0.017	0.043	0.062	0.071	0.080	0.092	0.115	0.140	0.150	0.173	0.180	0.215	0.240	0.260	0.285	0.310	0.465
	F	0.005	0.009	0.018	0.050	0.073	0.084	0.095	0.109	0.138	0.165	0.178	0.202	0.210	0.248	0.275	0.295	0.320	0.343	0.515
	G	0.005	0.010	0.019	0.056	0.084	0.096	0.109	0.126	0.160	0.190	0.205	0.231	0.240	0.280	0.310	0.330	0.355	0.375	0.563
	H	0.005	0.010	0.020	0.066	0.102	0.116	0.130	0.150	0.190	0.228	0.243	0.271	0.280	0.320	0.355	0.375	0.398	0.418	0.627
	I	0.005	0.011	0.021	0.076	0.119	0.134	0.150	0.173	0.220	0.265	0.280	0.310	0.320	0.360	0.400	0.420	0.440	0.460	0.690
	J	0.006	0.012	0.024	0.084	0.135	0.152	0.170	0.197	0.250	0.298	0.315	0.349	0.360	0.405	0.445	0.465	0.485	0.503	0.755
	K	0.007	0.013	0.026	0.092	0.150	0.170	0.190	0.220	0.280	0.330	0.350	0.388	0.400	0.450	0.490	0.510	0.530	0.545	0.818
	L	0.007	0.014	0.028	0.101	0.165	0.186	0.208	0.240	0.305	0.360	0.385	0.419	0.430	0.485	0.525	0.545	0.568	0.588	0.882
	M	0.008	0.015	0.030	0.110	0.180	0.202	0.225	0.260	0.330	0.390	0.420	0.450	0.460	0.520	0.560	0.580	0.605	0.630	0.945
	N	0.008	0.016	0.032	0.119	0.195	0.218	0.242	0.280	0.355	0.420	0.455	0.481	0.490	0.555	0.595	0.615	0.642	0.672	1.008
	S	0.002	0.004	0.008	0.014	0.020	0.025	0.030	0.037	0.050	0.080	0.100	0.123	0.130	0.150	0.170	0.190	0.220	0.240	–
	T	0.004	0.008	0.015	0.028	0.040	0.050	0.060	0.070	0.090	0.110	0.130	0.160	0.170	0.190	0.210	0.230	0.260	0.275	–
	U	0.007	0.013	0.026	0.048	0.070	0.080	0.090	0.107	0.140	0.170	0.200	0.223	0.230	0.240	0.270	0.300	0.360	0.375	–
	V	0.010	0.019	0.038	0.069	0.100	0.115	0.130	0.153	0.200	0.250	0.280	0.310	0.320	0.340	0.400	0.440	0.510	0.530	–
	W	0.012	0.025	0.049	0.089	0.130	0.150	0.170	0.200	0.260	0.330	0.380	0.418	0.430	0.450	0.470	0.490	0.520	0.540	–
	X	0.014	0.028	0.056	0.103	0.150	0.180	0.210	0.250	0.330	0.420	0.480	0.533	0.550	0.580	–	–	–	–	–
Y	0.017	0.034	0.068	0.124	0.180	0.220	0.260	0.317	0.430	0.550	0.700	0.700	0.700	0.740	–	–	–	–	–	
Z	0.024	0.047	0.094	0.172	0.250	0.325	0.400	0.533	0.800	1.000	1.100	1.175	1.200	1.200	–	–	–	–	–	





HSS DRILLS



HSS DRILLS – NAVIGATOR TOOL MATERIALS





Tool materials

High Speed Steel		A medium-alloyed high speed steel that has good machinability and good performance. HSS exhibits hardness, toughness and wear resistance characteristics that make it attractive in a wide range of applications, for example in drills and taps.
Cobalt High Speed Steel		This high speed steel contains cobalt for increased hot hardness. The composition of HSCo is a good combination of toughness and hardness. It has good machinability and good wear resistance, which makes it usable for drills, taps, milling cutters and reamers.





Carbide materials

Carbide and High Speed Steel		Combined carbide and high speed steel materials typically joined together with high temperature braze alloy as the interface. This brazed combination of tool materials offers a solid carbide cutting portion which provides high compression strength, hardness and wear resistance attached to a high speed steel body which provides flexural strength and toughness in the tool body.
-------------------------------------	---	--

Surface Treatments

Bright (uncoated)		Bright finish (uncoated surface) improves chip flow in soft or non-ferrous materials, plastics and composites while maintaining sharp cutting edges.
Combination Bright and Steam Tempered		Combination of bright and steam tempering can be effective as the blue oxide more porous surface acts to retain and pull cutting fluid into the hole while the bright surface assists in chip evacuation. This combination is achieved by grinding the bright surface after tempering.
Steam Tempering		Steam tempering gives a strongly adhering blue oxide surface that acts to retain cutting fluid and prevent chip to tool welding, thereby counteracting the formation of a built-up edge. Steam tempering can be applied to any bright tool but is most effective on drills and taps.
Bronze Tempering		Bronze tempering creates a smooth thin bronze oxide layer on the tool surface. Similar to Steam Tempering it helps to prevent chip to tool welding and aids in chip evacuation. Bronze tempering can be applied to any bright tool and can also be applied in combination with Steam Tempering on some tools.

Surface Coatings

Bright and TiN (Tip Coating)		Titanium Nitride is a gold coloured ceramic coating applied by physical vapor deposition (PVD). High hardness combined with low friction properties ensures longer tool life and/or better cutting performance over tools which have not been coated.
Titanium Nitride (TiN)		Titanium Nitride is a gold coloured ceramic coating applied by physical vapor deposition (PVD). High hardness combined with low friction properties ensures longer tool life and/or better cutting performance over tools which have not been coated.
Titanium Aluminium Nitride coatings (TiAlN, TiAlN-Top & X-CEED)		Titanium Aluminium Nitride is a multi layer ceramic coating applied by PVD coating technology, which exhibits high toughness and oxidation stability. These properties make it ideal for higher speeds and feeds, while at the same time improving tool life. TiAlN is used in drilling, tapping, and milling applications and can be suitable for use when machining without coolant. TiAlN-Top coating is the same as TiAlN but with a post-coating process designed to smooth out imperfections, enhance chip flow and reduce built up edge.
Alcrona coatings (Alcrona-Top)		The Alcrona (AlCrN) family of coatings are aluminium chromium nitride coatings mostly used for milling cutters. The two unique properties of these coatings are high hot hardness and high oxidation resistance. When used on tools for machining applications involving heavy mechanical and thermal stresses, these properties translate into superior wear resistance. Multiple levels or specific versions of these coatings are available and specific for various tools and applications.



Material code (BMC)	HSS-E	HSS	HSS	HSS	HSS	HSS	HSS-E	HSS-E	HSS	HSS HM	HSS-E	HSS-E	HSS-E
Basic standard group (BSG)		DIN 1897	DIN 1897	DIN 1897	DIN 1897	DIN ANSI	DIN 1897	DIN 1897	DIN 1897	DIN 8037	DIN 1899	DIN ANSI	DIN ANSI
Usable length (ULDR)	1xD	1.25xD	1xD	1.5xD	2.5xD	2.5xD	2.5xD	2.5xD	2.5xD	2.5xD	2.5xD	3xD	3xD
Application angle	180°	120°	90°/120°	120°	135°	135°	130°	135°	130°	118°	118°	130°	130°
Coating	Bronze	ST	Bright	ST	ST	TiN-Tip	Bronze	Bronze	TiN	Bright ST	Bright	Bright	Alcrona Top
Shank													
Spiral form	λ20-35°	λ20-35°	λ20-35°	λ20-35°	λ20-35°	λ20-35°	λ20-35°	λ20-35°	λ32-40°	λ10-20°	λ20-35°	λ>35°	λ>35°
Hand (Cutting direction)													
Cooling (CSP)													
Product Family Code	A723	A119	A122	A123	A120	A022	A620	A117	A520	A124	A720	A920	A921
	6.00 - 8.00	3.30 - 5.10	6.00 - 20.00	3/32 - 1/4	0.50 - 25.00	0.50 - 16.00	2.50 - 13.00	1.00 - 13.00	3.00 - 13.00	3.00 - 16.00	0.15 - 1.40	1.00 - 20.00	2.50 - 16.00
	76	77	78	79	80	82	84	86	88	90	91	92	94
P	P1	■	■	■	■	■	■	■	■	■	■	■	■
	P2	■	■	■	■	■	■	■	■	■	■	■	■
	P3	■	■	■	■	■	■	■	■	■	■	■	■
	P4	■	■	■	■	■	■	■	■	■	■	■	■
M	M1		■	■	■	■	■	■	■	■	■	■	■
	M2		■	■	■	■	■	■	■	■	■	■	■
	M3		■	■	■	■	■	■	■	■	■	■	■
	M4		■	■	■	■	■	■	■	■	■	■	■
K	K1			■	■	■	■	■	■	■	■	■	■
	K2			■	■	■	■	■	■	■	■	■	■
	K3			■	■	■	■	■	■	■	■	■	■
	K4			■	■	■	■	■	■	■	■	■	■
	K5			■	■	■	■	■	■	■	■	■	■
N	N1		■	■	■	■	■	■	■	■	■	■	■
	N2		■	■	■	■	■	■	■	■	■	■	■
	N3		■	■	■	■	■	■	■	■	■	■	■
	N4		■	■	■	■	■	■	■	■	■	■	■
	N5												
S	S1		■	■	■	■	■	■	■	■	■	■	■
	S2		■	■	■	■	■	■	■	■	■	■	■
	S3		■	■	■	■	■	■	■	■	■	■	■
	S4		■	■	■	■	■	■	■	■	■	■	■
H	H1												
	H2												
	H3												
	H4												

■ Primary use ■ Possible use



	HSS	HSS	HSS	HSS	HSS	HSS-E	HSS-E	HSS HM	HSS	HSS-E	HSS-E	HSS-E	HSS	HSS	HSS	
	DIN 338	DIN 338	DIN 338	DIN 338	DIN 338	DIN 338	DIN 338	DIN 338	DIN 338	DIN 338	DIN ANSI	DIN ANSI	DIN ANSI	DIN ANSI	DIN ANSI	DIN ANSI
	4xD	4xD	4xD	4xD	4xD	4xD	4xD	4xD	4xD	4xD	5xD	6xD	6xD	6xD	4xD	4xD
	118°	118°	118°	118°	135°	130°	135°	118°	130°	130°	130°	130°	130°	118°	135°	118°
	TiN-Tip	TiN-Tip	ST	ST	ST	Bright	Bronze	Bright ST	TiN	TiAlN Top	Bright	Alcrona Top	ST	Bright	Bright	Bright
	λ>20-35°	λ>20-35°	λ>20-35°	λ>20-35°	λ>35°	VA	λ>20-35°	λ>20-35°	λ>32-40°	λ>35°	λ>35°	λ>35°	λ>20-35°	λ>20-35°	λ>20-35°	λ>20-35°
	R	R	R	L	R	R	R	R	R	R	R	R	R	R	R	R
	A002	A002S	A100	A101	A108	A147	A777	A160	A510	A553	A900	A901	A170	A243	A244	
	1.00 - 16.00	2.00 - 13.00	0.20 - 20.00	1.00 - 12.00	1.00 - 16.00	0.30 - 15.0	0.30 - 16.00	4.00 - 16.00	3.00 - 14.00	5.00 - 20.00	1.00 - 20.00	1.50 - 16.00	13.00 - 1.1/2	3/32 - 1/4	1/8 - 1/4	
	96	98	99	103	104	106	108	110	111	113	114	116	118	120	121	
P1	■	■	■	■	■	■	■	■	■	■	■	■	■	■	■	■
P2	■	■	■	■	■	■	■	■	■	■	■	■	■	■	■	■
P3	■	■	■	■	■	■	■	■	■	■	■	■	■	■	■	■
P4	■	■	■	■	■	■	■	■	■	■	■	■	■	■	■	■
M1	■	■	■	■	■	■	■	■	■	■	■	■	■	■	■	■
M2	■	■	■	■	■	■	■	■	■	■	■	■	■	■	■	■
M3	■	■	■	■	■	■	■	■	■	■	■	■	■	■	■	■
M4	■	■	■	■	■	■	■	■	■	■	■	■	■	■	■	■
K1	■	■	■	■	■	■	■	■	■	■	■	■	■	■	■	■
K2	■	■	■	■	■	■	■	■	■	■	■	■	■	■	■	■
K3	■	■	■	■	■	■	■	■	■	■	■	■	■	■	■	■
K4	■	■	■	■	■	■	■	■	■	■	■	■	■	■	■	■
K5	■	■	■	■	■	■	■	■	■	■	■	■	■	■	■	■
N1	■	■	■	■	■	■	■	■	■	■	■	■	■	■	■	■
N2	■	■	■	■	■	■	■	■	■	■	■	■	■	■	■	■
N3	■	■	■	■	■	■	■	■	■	■	■	■	■	■	■	■
N4	■	■	■	■	■	■	■	■	■	■	■	■	■	■	■	■
N5	■	■	■	■	■	■	■	■	■	■	■	■	■	■	■	■
S1	■	■	■	■	■	■	■	■	■	■	■	■	■	■	■	■
S2	■	■	■	■	■	■	■	■	■	■	■	■	■	■	■	■
S3	■	■	■	■	■	■	■	■	■	■	■	■	■	■	■	■
S4	■	■	■	■	■	■	■	■	■	■	■	■	■	■	■	■
H1																
H2																
H3																
H4																

■ Primary use ■ Possible use



Material code (BMC)	HSS	HSS-E	HSS-E	HSS	HSS-E	HSS-E	HSS-E	HSS	HSS	HSS-E	HSS HM	HSS	HSS
Basic standard group (BSG)	DIN 340	DIN ANSI	DIN ANSI	BS 328	DIN 1869-1	DIN 1869-2	DIN 1869-3	DIN 345	DIN 345	DIN 345	DIN 345	DIN 341	DIN 1870(1)
Usable length (ULDR)	6×D	10×D	10×D	10×D	15×D	20×D	25×D	4×D	4×D	4×D	4×D	6×D	10×D
Application angle	118°	130°	130°	118°	130°	130°	130°	118°	118°	118°	118°	118°	118°
Coating	ST	Bright	Alcrona Top	ST	Bright	Bright	Bright	ST	TiN	Bronze	Bright ST	ST	ST
Shank													
Spiral form	λ>20-35°	λ>35°	λ>35°	λ>20-35°	λ>35°	λ>35°	λ>35°	λ>20-35°	λ>20-35°	λ>20-35°	λ>20-35°	λ>20-35°	λ>20-35°
Hand (Cutting direction)	R	R	R	R	R	R	R	R	R	R	R	R	R
Cooling (CSP)													
Product Family Code	A110	A940	A941	A125	A976	A977	A978	A130	A530	A730	A166	A350	A345
	0.50 - 1"	1.00 - 20.00	1.00 - 16.00	1.40 - 1"	1.50 - 14.00	1.50 - 14.00	3.00 - 10.00	3.00 - 50.80	8.50 - 40.00	10.00 - 32.00	10.00 - 33.00	5.00 - 50.00	8.00 - 50.00
	122	124	126	128	130	132	133	134	140	141	143	144	146
P	P1	■	■	■	■	■	■	■	■	■	■	■	■
	P2	■	■	■	■	■	■	■	■	■	■	■	■
	P3	■	■	■	■	■	■	■	■	■	■	■	■
	P4	■	■	■	■	■	■	■	■	■	■	■	■
M	M1	■	■	■	■	■	■	■	■	■	■	■	■
	M2	■	■	■	■	■	■	■	■	■	■	■	■
	M3	■	■	■	■	■	■	■	■	■	■	■	■
	M4	■	■	■	■	■	■	■	■	■	■	■	■
K	K1	■	■	■	■	■	■	■	■	■	■	■	■
	K2	■	■	■	■	■	■	■	■	■	■	■	■
	K3	■	■	■	■	■	■	■	■	■	■	■	■
	K4	■	■	■	■	■	■	■	■	■	■	■	■
	K5	■	■	■	■	■	■	■	■	■	■	■	■
N	N1	■	■	■	■	■	■	■	■	■	■	■	■
	N2	■	■	■	■	■	■	■	■	■	■	■	■
	N3	■	■	■	■	■	■	■	■	■	■	■	■
	N4	■	■	■	■	■	■	■	■	■	■	■	■
	N5	■	■	■	■	■	■	■	■	■	■	■	■
S	S1	■	■	■	■	■	■	■	■	■	■	■	■
	S2	■	■	■	■	■	■	■	■	■	■	■	■
	S3	■	■	■	■	■	■	■	■	■	■	■	■
	S4	■	■	■	■	■	■	■	■	■	■	■	■
H	H1												
	H2												
	H3												
	H4												

■ Primary use ■ Possible use



	HSS	HSS	HSS	HSS	HSS	HSS	HSS	HSS	HSS	HSS-E	HSS-E	HSS	HSS	HSS	HSS-E
	DIN 1870(1)	DIN 1870(2)	DIN 8374	DIN 8376	DIN 8377	DORNER	DORNER	DIN 333A	DIN 333A	DIN 333A	DIN 333A	DIN 333R	DORNER	BS 328	DIN 333A
	15xD	20xD	4xD	4xD	4xD	2.5xD	2.5xD	1xD	1xD	1xD	1xD	1xD	1xD	1xD	1xD
	A951	A952	A400	A402	A405	A412	A413	A200	A205	A206	A266	A210	A201	A225	A237
	10.00 - 30.00	8.00 - 40.00	M3 - M10	M3 - M10	M6 - M18	M3 - M10	M3 - M10	0.50 - 12.50	1.00 - 5.00	1.00 - 5.00	1.00 - 5.00	0.50 - 10.00	0.63 - 6.00	3/64 - 5/16	1.60 - 10.00
	148	149	150	151	152	153	154	155	156	157	158	159	160	161	162
P1	■	■	■	■	■	■	■	■	■	■	■	■	■	■	■
P2	■	■	■	■	■	■	■	■	■	■	■	■	■	■	■
P3	■	■	■	■	■	■	■	■	■	■	■	■	■	■	■
P4	■	■	■	■	■	■	■	■	■	■	■	■	■	■	■
M1	■	■	■	■	■	■	■	■	■	■	■	■	■	■	■
M2	■	■	■	■	■	■	■	■	■	■	■	■	■	■	■
M3	■	■	■	■	■	■	■	■	■	■	■	■	■	■	■
M4	■	■	■	■	■	■	■	■	■	■	■	■	■	■	■
K1	■	■	■	■	■	■	■	■	■	■	■	■	■	■	■
K2	■	■	■	■	■	■	■	■	■	■	■	■	■	■	■
K3	■	■	■	■	■	■	■	■	■	■	■	■	■	■	■
K4	■	■	■	■	■	■	■	■	■	■	■	■	■	■	■
K5	■	■	■	■	■	■	■	■	■	■	■	■	■	■	■
N1	■	■	■	■	■	■	■	■	■	■	■	■	■	■	■
N2	■	■	■	■	■	■	■	■	■	■	■	■	■	■	■
N3	■	■	■	■	■	■	■	■	■	■	■	■	■	■	■
N4	■	■	■	■	■	■	■	■	■	■	■	■	■	■	■
N5															
S1	■	■	■	■	■	■	■	■	■	■	■	■	■	■	■
S2	■	■	■	■	■	■	■	■	■	■	■	■	■	■	■
S3	■	■	■	■	■	■	■	■	■	■	■	■	■	■	■
S4	■	■	■	■	■	■	■	■	■	■	■	■	■	■	■
H1															
H2															
H3															
H4															



		HSS-E	HSS-E	HSS	HSS	HSS	HSS	HSS
Material code (BMC)		HSS-E	HSS-E	HSS	HSS	HSS	HSS	HSS
Basic standard group (BSG)		DIN 333R	DORMER	DIN ANSI	DIN 338	DIN 338	DIN 338	DIN 338
Usable length (ULDR)		1xD	1xD	2.5xD	4xD	4xD	4xD	4xD
Application angle		R	60°	135°	118°	118°	118°	118°
Coating		Bright	Bright	TiN-Tip	TiN-Tip	TiN-Tip	TiN-Tip	TiN-Tip
Shank		H						
Spiral form				λ20-35°	λ20-35°	λ20-35°	λ20-35°	λ20-35°
Hand (Cutting direction)		R	R	R	R	R	R	R
Cooling (CSP)								
Product Family Code		A238	A242	A088	A095	A087	A094	A089
		1.60 - 8.00	1.00 - 5.00	Set	Set	Set	Set	Set
		163	164	165	165	166	166	167
P	P1	■	■					
	P2	■	■					
	P3	■	■					
	P4	▣	▣					
M	M1	▣	▣					
	M2	▣	▣					
	M3	▣	▣					
	M4	▣	▣					
K	K1	■	■					
	K2	▣	▣					
	K3	▣	▣					
	K4	▣	▣					
	K5	▣	▣					
N	N1	▣	▣					
	N2	▣	▣					
	N3	▣	▣					
	N4	▣	▣					
	N5							
S	S1	▣	▣					
	S2	▣	▣					
	S3	▣	▣					
	S4	▣	▣					
H	H1							
	H2							
	H3							
	H4							

■ Primary use ▣ Possible use



	A099	A099	A199	A080	A190
--	------	------	------	------	------

	Set	Drillboy	Set	Set	Set
--	-----	----------	-----	-----	-----

	168	168	169	169	170
--	-----	-----	-----	-----	-----

P1					
P2					
P3					
P4					
M1					
M2					
M3					
M4					
K1					
K2					
K3					
K4					
K5					
N1					
N2					
N3					
N4					
N5					
S1					
S2					
S3					
S4					
H1					
H2					
H3					
H4					



Material code (BMC)		HSS	HSS	HSS	HSS-E		
Basic standard group (BSG)		DIN 338	DIN 338	DIN 338	DIN 338		
Usable length (ULDR)		4xD	4xD	4xD	4xD		
Application angle		118°	118°	135°	135°	60°	
Coating		ST	ST	ST	Bronze		
Shank							
Spiral form		λ 20-35°	λ 20-35°	λ >35°	λ 20-35°		
Hand (Cutting direction)		R	R	R	R		
Cooling (CSP)							
Product Family Code		A191	A191	A188	A295	A296	M150 M151
		Set	Set	Set	Set	Set	
		📖 171	📖 171	📖 172	📖 172	📖 173	📖 173 📖 174
P	P1						
	P2						
	P3						
	P4						
M	M1						
	M2						
	M3						
	M4						
K	K1						
	K2						
	K3						
	K4						
	K5						
N	N1						
	N2						
	N3						
	N4						
	N5						
S	S1						
	S2						
	S3						
	S4						
H	H1						
	H2						
	H3						
	H4						

■ Primary use ▣ Possible use



A723



HSS-E (5% Cobalt) Spot Weld Drill, Bronze Tempered Finish

Drill with specially designed lip and spur point to remove or "drill out" spot welded areas, commonly for removing welds in a vehicle repair shop. Short flute length makes it more sturdy and less prone to shattering when being used in a hand-held device. The bronze finish is a thin oxide layer and an indication for Cobalt.

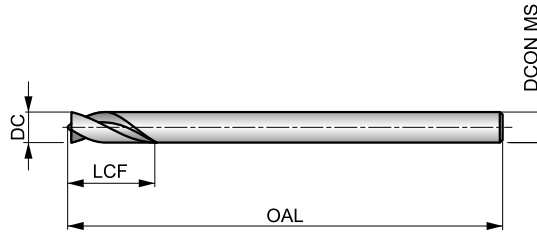

HSS-E	DORMER	1×D
Bronze		20-35°
R	DC h8	

Workpiece material group suitability, starting values for cutting speed (m/min) and feed Alpha Code. Tables with feed per revolution can be found starting from page 175.

Product	DC [mm]	DC [inch]	LCF [mm]	OAL [mm]	DCON MS [mm]
P1.1 ■ 33 D					
P1.2 ■ 37 D					
P1.3 ■ 38 D					
P2.1 ■ 28 D					
P2.2 ■ 25 C					
P3.1 ■ 20 C					
P3.2 ■ 20 C					
P4.1 ■ 20 C					
A7236.0X66	6.00	0.2362	18.0	66.0	6.00
A7236.0X93	6.00	0.2362	18.0	93.0	6.00
A7238.0X79	8.00	0.3150	24.0	79.0	8.00
A7238.0X117	8.00	0.3150	24.0	117.0	8.00



A119



HSS Double Ended Stub Drill, Steam Tempered Finish

A short double-ended drill designed for drilling holes through sheet metal. Possible to use both ends, giving twice the tool life. A 120° conventional point to aid self-centering. Suitable for drilling in many materials. Steam tempered finish retains cutting fluid and prevents chip to tool welding.

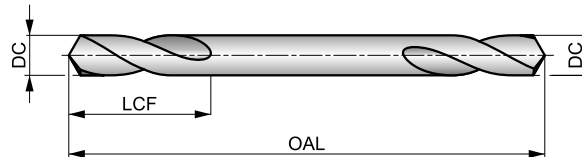

HSS	DIN 1897	1.25xD
120°	ST	
20-35°	R	DC h8

Workpiece material group suitability, starting values for cutting speed (m/min) and feed Alpha Code. Tables with feed per revolution can be found starting from page 175.

P1.1 ■ 31 C	P1.2 ■ 34 C	P1.3 ■ 35 C	P2.1 ■ 26 C	P2.2 ■ 23 C	P2.3 ■ 20 C	P3.1 ■ 12 C	P3.2 ■ 9 C	P3.3 ■ 8 C	P4.1 ■ 7 C	P4.2 ■ 6 C	P4.3 ■ 5 A	M1.1 ■ 21 A	M1.2 ■ 17 A
M2.1 ■ 18 A	M2.2 ■ 15 A	M3.1 ■ 8 C	M3.2 ■ 7 C	M3.3 ■ 6 C	M4.1 ■ 10 A	N1.1 ■ 33 C	N1.2 ■ 25 C	N1.3 ■ 17 C	N2.1 ■ 46 C	N2.2 ■ 42 C	N2.3 ■ 30 C	N3.1 ■ 56 C	N3.2 ■ 33 C
N3.3 ■ 17 A	N4.1 ■ 30 I	N4.2 ■ 35 C	S1.1 ■ 27 A	S1.2 ■ 12 A	S1.3 ■ 7 A	S2.1 ■ 5 C	S2.2 ■ 4 C	S3.1 ■ 4 C	S3.2 ■ 3 C	S4.1 ■ 3 C	S4.2 ■ 2 C		

Sheet Metal Drill.

Product	DC	DC	LCF	OAL	DCON MS
	[mm]	[inch]	[mm]	[mm]	[mm]
A1193.3	3.30	0.1299	11.0	49.0	3.30
A1193.6	3.60	0.1417	12.0	52.0	3.60
A1194.1	4.10	0.1614	14.0	55.0	4.10
A1194.2	4.20	0.1654	14.0	55.0	4.20
A1194.9	4.90	0.1929	17.0	62.0	4.90
A1195.1	5.10	0.2008	17.0	62.0	5.10



A122



HSS Spotting Drill, Bright Finish

Used to create a hole in the material to be drilled to ensure the start point is accurate. Comes with either a 90° or 120° point angle, giving you two options of countersink. Bright surface finish. Suitable for drilling in many materials.

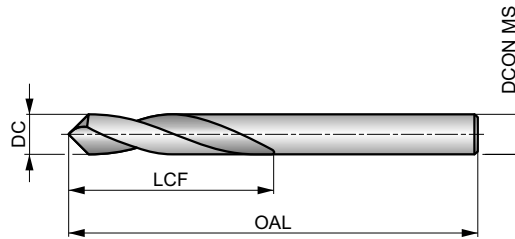

HSS	DIN 1897	1xD
90°/120°	Bright	
λ 20-35°	R	DC h8

Workpiece material group suitability, starting values for cutting speed (m/min) and feed Alpha Code. Tables with feed per revolution can be found starting from page 175.

P1.1 ■ 36 E	P1.2 ■ 40 E	P1.3 ■ 41 E	P2.1 ■ 31 E	P2.2 ■ 27 C	P2.3 ■ 24 C	P3.1 ■ 21 C	P3.2 ■ 17 C	P3.3 ■ 14 C	P4.1 ■ 12 C	P4.2 ■ 10 C	P4.3 ■ 9 B	M1.1 ■ 22 C	M1.2 ■ 19 C
M2.1 ■ 20 C	M2.2 ■ 16 C	M3.1 ■ 10 D	M3.2 ■ 9 D	M3.3 ■ 8 D	M4.1 ■ 10 B	K1.1 ■ 32 E	K1.2 ■ 24 C	K1.3 ■ 18 C	K2.1 ■ 25 C	K2.2 ■ 20 C	K2.3 ■ 16 B	K3.1 ■ 22 C	K3.2 ■ 17 C
K3.3 ■ 13 B	K4.1 ■ 20 C	K4.2 ■ 15 C	K4.3 ■ 11 B	K4.4 ■ 10 B	K4.5 ■ 8 B	K5.1 ■ 23 C	K5.2 ■ 17 C	K5.3 ■ 13 B	N1.1 ■ 33 E	N1.2 ■ 25 E	N1.3 ■ 17 E	N2.1 ■ 46 D	N2.2 ■ 42 D
N2.3 ■ 30 D	N3.1 ■ 56 D	N3.2 ■ 33 E	N3.3 ■ 17 D	N4.1 ■ 30 F	N4.2 ■ 35 E	N4.3 ■ 17 D	S1.1 ■ 27 C	S1.2 ■ 12 B	S1.3 ■ 7 A	S2.1 ■ 11 C	S2.2 ■ 6 A	S3.1 ■ 8 C	S3.2 ■ 4 A
S4.1 ■ 6 C	S4.2 ■ 3 A												

Product	DC	DC	LCF	OAL	DCON MS
	[mm]	[inch]			
A1226.0X90	6.00	0.2362	30.0	66.0	6.00
A1226.0X120	6.00	0.2362	30.0	66.0	6.00
A1228.0X90	8.00	0.3150	33.0	79.0	8.00
A1228.0X120	8.00	0.3150	33.0	79.0	8.00
A12210.0X90	10.00	0.3937	35.0	89.0	10.00
A12210.0X120	10.00	0.3937	35.0	89.0	10.00
A12212.0X90	12.00	0.4724	40.0	102.0	12.00
A12212.0X120	12.00	0.4724	40.0	102.0	12.00
A12216.0X90	16.00	0.6299	40.0	115.0	16.00
A12216.0X120	16.00	0.6299	40.0	115.0	16.00
A12220.0X90	20.00	0.7874	55.0	131.0	20.00
A12220.0X120	20.00	0.7874	55.0	131.0	20.00



A123



HSS Stub Drill, Steam Tempered Finish, for Sheet Metal

Specially designed for drilling thin materials and sheet metal. A 120° point and a steam tempered finish which stops workpiece material from sticking to the cutting edge, giving a better hole finish and more accurate diameter. Suitable for drilling in many materials.

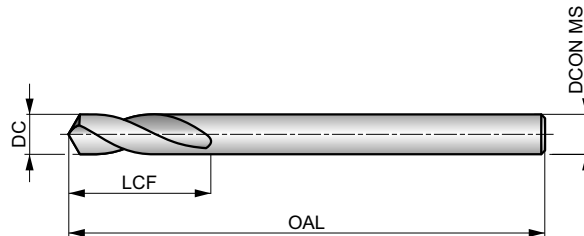

HSS	DIN 1897	1.5×D
120°	ST	
λ 20-35°	R	DC h8

Workpiece material group suitability, starting values for cutting speed (m/min) and feed Alpha Code. Tables with feed per revolution can be found starting from page 175.

P1.1 ■ 36 E	P1.2 ■ 40 E	P1.3 ■ 41 E	P2.1 ■ 31 E	P2.2 ■ 27 C	P2.3 ■ 24 C	P3.1 ■ 21 C	P3.2 ■ 17 C	P3.3 ■ 14 C	P4.1 ■ 12 C	P4.2 ■ 10 C	P4.3 ■ 9 B	M1.1 ■ 22 C	M1.2 ■ 19 C
M2.1 ■ 20 C	M2.2 ■ 16 C	M3.1 ■ 10 D	M3.2 ■ 9 D	M3.3 ■ 8 D	M4.1 ■ 10 B	N1.1 ■ 33 E	N1.2 ■ 25 E	N1.3 ■ 17 E	N2.1 ■ 46 D	N2.2 ■ 42 D	N2.3 ■ 30 D	N3.1 ■ 56 D	N3.2 ■ 33 E
N3.3 ■ 17 D	N4.1 ■ 30 F	N4.2 ■ 35 E	N4.3 ■ 17 D	S1.1 ■ 27 C	S1.2 ■ 12 B	S1.3 ■ 7 A	S2.1 ■ 11 C	S2.2 ■ 6 A	S3.1 ■ 8 C	S3.2 ■ 4 A	S4.1 ■ 6 C	S4.2 ■ 3 A	

Sheet Metal Drill.

Product	DC	DC	DC	LCF	OAL	DCON MS
	[inch]	[mm]	[inch]	[mm]	[mm]	[mm]
A1233/32S	3/32	2.38	0.0937	14.0	43.0	2.38
A1232.5S	–	2.50	0.0984	14.0	43.0	2.50
A1233.0S	–	3.00	0.1181	16.0	46.0	3.00
A1231/8S	1/8	3.18	0.1252	18.0	49.0	3.18
A1233.2S	–	3.20	0.1260	18.0	49.0	3.20
A1233.3S	–	3.30	0.1299	18.0	49.0	3.30
A1233.5S	–	3.50	0.1378	18.0	52.0	3.50
A1233.7S	–	3.70	0.1457	18.0	52.0	3.70
A1235/32S	5/32	3.97	0.1563	18.0	55.0	3.97
A1234.0S	–	4.00	0.1575	18.0	55.0	4.00
A1234.1S	–	4.10	0.1614	18.0	55.0	4.10
A1234.2S	–	4.20	0.1654	18.0	55.0	4.20
A1234.5S	–	4.50	0.1772	18.0	58.0	4.50
A1233/16S	3/16	4.76	0.1875	18.0	62.0	4.76
A1234.8S	–	4.80	0.1890	18.0	62.0	4.80
A1234.9S	–	4.90	0.1929	18.0	62.0	4.90
A1235.0S	–	5.00	0.1969	18.0	62.0	5.00
A1235.5S	–	5.50	0.2165	18.0	66.0	5.50
A1237/32S	7/32	5.56	0.2188	18.0	66.0	5.56
A1236.0S	–	6.00	0.2362	18.0	66.0	6.00
A1231/4S	1/4	6.35	0.2500	19.0	70.0	6.35



A120



HSS Stub Drill, Steam Tempered Finish

Versatile drill with Steam tempered finish. A 135° split point reduces the forces when drilling and prevents the drill from wandering over the surface of the material. Steam tempered finish retains cutting fluid and prevents chip to tool welding. Suitable for hand-held and machine drilling of many materials.

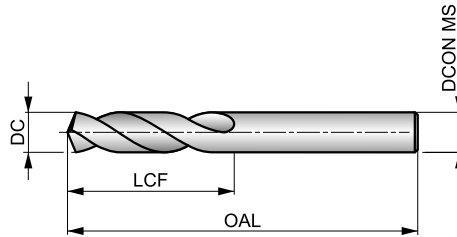

HSS	DIN 1897	2.5×D
135°	ST	
λ 20-35°	R	DC h8

Workpiece material group suitability, starting values for cutting speed (m/min) and feed Alpha Code. Tables with feed per revolution can be found starting from page 175.

P1.1 ■ 36 J	P1.2 ■ 40 J	P1.3 ■ 41 J	P2.1 ■ 31 J	P2.2 ■ 27 G	P2.3 ■ 24 F	P3.1 ■ 21 G	P3.2 ■ 17 G	P3.3 ■ 14 F	P4.1 ■ 12 G	P4.2 ■ 10 F	P4.3 ■ 9 E	M1.1 ■ 22 F	M1.2 ■ 19 F
M2.1 ■ 20 F	M2.2 ■ 16 F	M3.1 ■ 10 H	M3.2 ■ 9 H	M3.3 ■ 8 H	M4.1 ■ 10 D	K1.1 ■ 32 J	K1.2 ■ 24 G	K1.3 ■ 18 G	K2.1 ■ 25 F	K2.2 ■ 20 F	K2.3 ■ 16 F	K3.1 ■ 22 F	K3.2 ■ 17 F
K3.3 ■ 13 F	K4.1 ■ 20 F	K4.2 ■ 15 F	K4.3 ■ 11 F	K4.4 ■ 10 F	K4.5 ■ 8 F	K5.1 ■ 23 F	K5.2 ■ 17 F	K5.3 ■ 13 F	N1.1 ■ 33 K	N1.2 ■ 25 K	N1.3 ■ 17 J	N2.1 ■ 46 I	N2.2 ■ 42 I
N2.3 ■ 30 I	N3.1 ■ 64 I	N3.2 ■ 38 J	N3.3 ■ 19 H	N4.1 ■ 30 K	N4.2 ■ 35 I	N4.3 ■ 17 G	S1.1 ■ 27 G	S1.2 ■ 16 E	S1.3 ■ 8 C	S2.1 ■ 11 F	S2.2 ■ 6 B	S3.1 ■ 8 F	S3.2 ■ 4 B
S4.1 ■ 6 F	S4.2 ■ 3 B												

DC <= 1mm Bright; 2,9mm => DC >= 13,0mm 118° Point.

Product	DC	DC	DC	LCF	OAL	DCON MS
	[inch]	[mm]	[inch]	[mm]	[mm]	[mm]
A120.5	–	0.50	0.0197	3.0	20.0	0.50
A120.6	–	0.60	0.0236	3.5	21.0	0.60
A120.7	–	0.70	0.0276	4.5	23.0	0.70
A1201/32	1/32	0.79	0.0313	5.0	24.0	0.79
A120.8	–	0.80	0.0315	5.0	24.0	0.80
A120.9	–	0.90	0.0354	5.5	25.0	0.90
A1201.0	–	1.00	0.0394	6.0	26.0	1.00
A1201.1	–	1.10	0.0433	7.0	28.0	1.10
A1203/64	3/64	1.19	0.0469	8.0	30.0	1.19
A1201.2	–	1.20	0.0472	8.0	30.0	1.20
A1201.3	–	1.30	0.0512	8.0	30.0	1.30
A1201.4	–	1.40	0.0551	9.0	32.0	1.40
A1201.5	–	1.50	0.0591	9.0	32.0	1.50
A1201/16	1/16	1.59	0.0625	10.0	34.0	1.59
A1201.6	–	1.60	0.0630	10.0	34.0	1.60
A1201.7	–	1.70	0.0669	10.0	34.0	1.70
A1201.8	–	1.80	0.0709	11.0	36.0	1.80
A1201.9	–	1.90	0.0748	11.0	36.0	1.90
A1205/64	5/64	1.98	0.0781	12.0	38.0	1.98
A1202.0	–	2.00	0.0787	12.0	38.0	2.00
A1202.1	–	2.10	0.0827	12.0	38.0	2.10
A1202.2	–	2.20	0.0866	13.0	40.0	2.20
A1202.25	–	2.25	0.0886	13.0	40.0	2.25

Product	DC	DC	DC	LCF	OAL	DCON MS
	[inch]	[mm]	[inch]	[mm]	[mm]	[mm]
A1202.3	–	2.30	0.0906	13.0	40.0	2.30
A1203/32	3/32	2.38	0.0938	14.0	43.0	2.38
A1202.4	–	2.40	0.0945	14.0	43.0	2.40
A1202.5	–	2.50	0.0984	14.0	43.0	2.50
A1202.6	–	2.60	0.1024	14.0	43.0	2.60
A1202.65	–	2.65	0.1043	14.0	43.0	2.65
A1202.7	–	2.70	0.1063	16.0	46.0	2.70
A1207/64	7/64	2.78	0.1094	16.0	46.0	2.78
A1202.8	–	2.80	0.1102	16.0	46.0	2.80
A1202.9	–	2.90	0.1142	16.0	46.0	2.90
A1203.0	–	3.00	0.1181	16.0	46.0	3.00
A1203.1	–	3.10	0.1220	18.0	49.0	3.10
A1201/8	1/8	3.18	0.1252	18.0	49.0	3.18
A1203.2	–	3.20	0.1260	18.0	49.0	3.20
A1203.25	–	3.25	0.1280	18.0	49.0	3.25
A1203.3	–	3.30	0.1299	18.0	49.0	3.30
A1203.4	–	3.40	0.1339	20.0	52.0	3.40
A1203.5	–	3.50	0.1378	20.0	52.0	3.50
A1209/64	9/64	3.57	0.1406	20.0	52.0	3.57
A1203.6	–	3.60	0.1417	20.0	52.0	3.60
A1203.7	–	3.70	0.1457	20.0	52.0	3.70
A1203.8	–	3.80	0.1496	22.0	55.0	3.80
A1203.9	–	3.90	0.1535	22.0	55.0	3.90



Product	DC	DC	DC	LCF	OAL	D CON MS
	[inch]	[mm]	[inch]	[mm]	[mm]	[mm]
A1205/32	5/32	3.97	0.1563	22.0	55.0	3.97
A1204.0	–	4.00	0.1575	22.0	55.0	4.00
A1204.1	–	4.10	0.1614	22.0	55.0	4.10
A1204.2	–	4.20	0.1654	22.0	55.0	4.20
A1204.3	–	4.30	0.1693	24.0	58.0	4.30
A12011/64	11/64	4.37	0.1719	24.0	58.0	4.37
A1204.4	–	4.40	0.1732	24.0	58.0	4.40
A1204.5	–	4.50	0.1772	24.0	58.0	4.50
A1204.6	–	4.60	0.1811	24.0	58.0	4.60
A1204.7	–	4.70	0.1850	24.0	58.0	4.70
A1203/16	3/16	4.76	0.1875	26.0	62.0	4.76
A1204.8	–	4.80	0.1890	26.0	62.0	4.80
A1204.9	–	4.90	0.1929	26.0	62.0	4.90
A1205.0	–	5.00	0.1969	26.0	62.0	5.00
A1205.1	–	5.10	0.2008	26.0	62.0	5.10
A12013/64	13/64	5.16	0.2031	26.0	62.0	5.16
A1205.2	–	5.20	0.2047	26.0	62.0	5.20
A1205.3	–	5.30	0.2087	26.0	62.0	5.30
A1205.4	–	5.40	0.2126	28.0	66.0	5.40
A1205.5	–	5.50	0.2165	28.0	66.0	5.50
A1207/32	7/32	5.56	0.2188	28.0	66.0	5.56
A1205.6	–	5.60	0.2205	28.0	66.0	5.60
A1205.7	–	5.70	0.2244	28.0	66.0	5.70
A1205.8	–	5.80	0.2283	28.0	66.0	5.80
A1205.9	–	5.90	0.2323	28.0	66.0	5.90
A12015/64	15/64	5.95	0.2344	28.0	66.0	5.95
A1206.0	–	6.00	0.2362	28.0	66.0	6.00
A1206.1	–	6.10	0.2402	31.0	70.0	6.10
A1206.2	–	6.20	0.2441	31.0	70.0	6.20
A1206.3	–	6.30	0.2480	31.0	70.0	6.30
A1201/4	1/4	6.35	0.2500	31.0	70.0	6.35
A1206.4	–	6.40	0.2520	31.0	70.0	6.40
A1206.5	–	6.50	0.2559	31.0	70.0	6.50
A1206.6	–	6.60	0.2598	31.0	70.0	6.60
A1206.7	–	6.70	0.2638	31.0	70.0	6.70
A1206.8	–	6.80	0.2677	34.0	74.0	6.80
A1206.9	–	6.90	0.2717	34.0	74.0	6.90
A1207.0	–	7.00	0.2756	34.0	74.0	7.00
A1207.1	–	7.10	0.2795	34.0	74.0	7.10
A1209/32	9/32	7.14	0.2813	34.0	74.0	7.14
A1207.2	–	7.20	0.2835	34.0	74.0	7.20
A1207.3	–	7.30	0.2874	34.0	74.0	7.30
A1207.4	–	7.40	0.2913	34.0	74.0	7.40
A1207.5	–	7.50	0.2953	34.0	74.0	7.50
A1207.6	–	7.60	0.2992	37.0	79.0	7.60
A1207.7	–	7.70	0.3031	37.0	79.0	7.70
A1207.8	–	7.80	0.3071	37.0	79.0	7.80
A1207.9	–	7.90	0.3110	37.0	79.0	7.90
A1205/16	5/16	7.94	0.3125	37.0	79.0	7.94
A1208.0	–	8.00	0.3150	37.0	79.0	8.00
A1208.1	–	8.10	0.3189	37.0	79.0	8.10
A1208.2	–	8.20	0.3228	37.0	79.0	8.20
A1208.3	–	8.30	0.3268	37.0	79.0	8.30
A1208.4	–	8.40	0.3307	37.0	79.0	8.40
A1208.5	–	8.50	0.3346	37.0	79.0	8.50
A1208.6	–	8.60	0.3386	40.0	84.0	8.60
A1208.7	–	8.70	0.3425	40.0	84.0	8.70
A12011/32	11/32	8.73	0.3438	40.0	84.0	8.73
A1208.8	–	8.80	0.3465	40.0	84.0	8.80
A1208.9	–	8.90	0.3504	40.0	84.0	8.90
A1209.0	–	9.00	0.3543	40.0	84.0	9.00
A1209.1	–	9.10	0.3583	40.0	84.0	9.10
A1209.2	–	9.20	0.3622	40.0	84.0	9.20
A1209.3	–	9.30	0.3661	40.0	84.0	9.30
A1209.4	–	9.40	0.3701	40.0	84.0	9.40

Product	DC	DC	DC	LCF	OAL	D CON MS
	[inch]	[mm]	[inch]	[mm]	[mm]	[mm]
A1209.5	–	9.50	0.3740	40.0	84.0	9.50
A1203/8	3/8	9.52	0.3750	43.0	89.0	9.52
A1209.6	–	9.60	0.3780	43.0	89.0	9.60
A1209.7	–	9.70	0.3819	43.0	89.0	9.70
A1209.8	–	9.80	0.3858	43.0	89.0	9.80
A1209.9	–	9.90	0.3898	43.0	89.0	9.90
A12010.0	–	10.00	0.3937	43.0	89.0	10.00
A12010.1	–	10.10	0.3976	43.0	89.0	10.10
A12010.2	–	10.20	0.4016	43.0	89.0	10.20
A12010.3	–	10.30	0.4055	43.0	89.0	10.30
A12013/32	13/32	10.32	0.4063	43.0	89.0	10.32
A12010.4	–	10.40	0.4094	43.0	89.0	10.40
A12010.5	–	10.50	0.4134	43.0	89.0	10.50
A12010.6	–	10.60	0.4173	43.0	89.0	10.60
A12010.7	–	10.70	0.4213	47.0	95.0	10.70
A12010.8	–	10.80	0.4252	47.0	95.0	10.80
A12010.9	–	10.90	0.4291	47.0	95.0	10.90
A12011.0	–	11.00	0.4331	47.0	95.0	11.00
A12011.1	–	11.10	0.4370	47.0	95.0	11.10
A1207/16	7/16	11.11	0.4375	47.0	95.0	11.11
A12011.2	–	11.20	0.4409	47.0	95.0	11.20
A12011.3	–	11.30	0.4449	47.0	95.0	11.30
A12011.5	–	11.50	0.4528	47.0	95.0	11.50
A12011.6	–	11.60	0.4567	47.0	95.0	11.60
A12011.7	–	11.70	0.4606	47.0	95.0	11.70
A12011.8	–	11.80	0.4646	47.0	95.0	11.80
A12011.9	–	11.90	0.4685	51.0	102.0	11.90
A12012.0	–	12.00	0.4724	51.0	102.0	12.00
A12012.1	–	12.10	0.4764	51.0	102.0	12.10
A12012.2	–	12.20	0.4803	51.0	102.0	12.20
A12012.5	–	12.50	0.4921	51.0	102.0	12.50
A1201/2	1/2	12.70	0.5000	51.0	102.0	12.70
A12013.0	–	13.00	0.5118	51.0	102.0	13.00
A12013.5	–	13.50	0.5315	54.0	107.0	13.50
A12014.0	–	14.00	0.5512	54.0	107.0	14.00
A1209/16	9/16	14.29	0.5625	56.0	111.0	14.29
A12014.5	–	14.50	0.5709	56.0	111.0	14.50
A12015.0	–	15.00	0.5906	56.0	111.0	15.00
A12015.5	–	15.50	0.6102	58.0	115.0	15.50
A1205/8	5/8	15.88	0.6250	58.0	115.0	15.88
A12016.0	–	16.00	0.6299	58.0	115.0	16.00
A12016.5	–	16.50	0.6496	60.0	119.0	16.50
A12017.0	–	17.00	0.6693	60.0	119.0	17.00
A12011/16	11/16	17.46	0.6875	62.0	123.0	17.46
A12017.5	–	17.50	0.6890	62.0	123.0	17.50
A12018.0	–	18.00	0.7087	62.0	123.0	18.00
A12018.5	–	18.50	0.7283	64.0	127.0	18.50
A12019.0	–	19.00	0.7480	64.0	127.0	19.00
A1203/4	3/4	19.05	0.7500	66.0	131.0	19.05
A12019.5	–	19.50	0.7677	66.0	131.0	19.50
A12020.0	–	20.00	0.7874	66.0	131.0	20.00
A12020.5	–	20.50	0.8071	68.0	136.0	20.50
A12013/16	13/16	20.64	0.8125	68.0	136.0	20.64
A12021.0	–	21.00	0.8268	68.0	136.0	21.00
A12022.0	–	22.00	0.8661	70.0	141.0	22.00
A1207/8	7/8	22.22	0.8750	70.0	141.0	22.22
A12023.0	–	23.00	0.9055	72.0	146.0	23.00
A12015/16	15/16	23.81	0.9375	75.0	151.0	23.81
A12024.0	–	24.00	0.9449	75.0	151.0	24.00
A12025.0	–	25.00	0.9843	75.0	151.0	25.00



A022



HSS Stub Drill, TiN-Tip Coated

Versatile drill with a specially designed 135° split point which helps self-centering when drilling by hand and in machines provides a more accurate hole with a better quality of finish. Suitable for drilling many materials. TiN-Tip coating improves performance and extends the tool life.

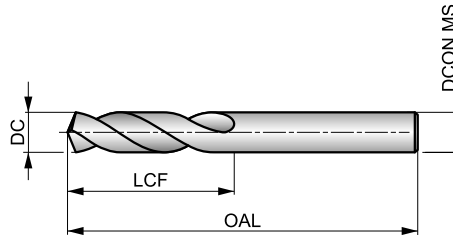

HSS	DIN ANSI	2.5×D
135°	TiN-Tip	
λ 20-35°	R	DC h8

Workpiece material group suitability, starting values for cutting speed (m/min) and feed Alpha Code. Tables with feed per revolution can be found starting from page 175.

P1.1 ■ 33 K	P1.2 ■ 37 K	P1.3 ■ 38 K	P2.1 ■ 28 K	P2.2 ■ 25 I	P2.3 ■ 22 G	P3.1 ■ 24 H	P3.2 ■ 19 H	P3.3 ■ 16 G	P4.1 ■ 14 H	P4.2 ■ 12 G	P4.3 ▣ 10 E	M1.1 ■ 21 G	M1.2 ■ 17 G
M2.1 ■ 18 G	M2.2 ■ 15 G	M3.1 ▣ 9 I	M3.2 ▣ 8 I	M3.3 ▣ 7 I	M4.1 ▣ 9 E	K1.1 ■ 32 K	K1.2 ■ 24 I	K1.3 ■ 18 I	K2.1 ■ 25 G	K2.2 ■ 20 G	K2.3 ▣ 16 G	K3.1 ■ 22 G	K3.2 ■ 17 G
K3.3 ▣ 13 G	K4.1 ■ 20 G	K4.2 ■ 15 G	K4.3 ▣ 11 G	K4.4 ▣ 10 G	K4.5 ▣ 8 G	K5.1 ■ 23 G	K5.2 ■ 17 G	K5.3 ▣ 13 G	N1.1 ■ 40 F	N1.2 ■ 30 F	N1.3 ■ 20 K	N2.1 ■ 49 J	N2.2 ■ 44 J
N2.3 ■ 32 J	N3.1 ▣ 64 I	N3.2 ▣ 38 K	N3.3 ▣ 19 H	N4.1 ▣ 30 K	N4.2 ▣ 35 I	N4.3 ▣ 17 G	S1.1 ■ 25 I	S1.2 ▣ 14 F	S1.3 ▣ 8 C	S2.1 ▣ 11 F	S2.2 ▣ 6 B	S3.1 ▣ 8 F	S3.2 ▣ 4 B
S4.1 ▣ 6 F	S4.2 ▣ 3 B												

DC < 2mm Bright; DC ≥ 2mm TiN Tipped and Split Point.
Products from this series are also available in set. Please see A088.

Product	DC [inch]	DC [mm]	DC [inch]	LCF [mm]	OAL [mm]	DCON MS [mm]
A022.5	—	0.50	0.0197	3.0	20.0	0.50
A022.6	—	0.60	0.0236	3.5	21.0	0.60
A022.7	—	0.70	0.0276	4.5	23.0	0.70
A0221/32	1/32	0.79	0.0313	13.0	35.0	0.79
A022.8	—	0.80	0.0315	5.0	24.0	0.80
A022.9	—	0.90	0.0354	5.5	25.0	0.90
A0221.0	—	1.00	0.0394	6.0	26.0	1.00
A0221.1	—	1.10	0.0433	7.0	28.0	1.10
A0223/64	3/64	1.19	0.0469	13.0	35.0	1.19
A0221.2	—	1.20	0.0472	8.0	30.0	1.20
A0221.3	—	1.30	0.0512	8.0	30.0	1.30
A0221.4	—	1.40	0.0551	9.0	32.0	1.40
A0221.5	—	1.50	0.0591	9.0	32.0	1.50
A0221/16	1/16	1.59	0.0625	16.0	41.0	1.59
A0221.6	—	1.60	0.0630	10.0	34.0	1.60
A0221.7	—	1.70	0.0669	10.0	34.0	1.70
A0221.8	—	1.80	0.0709	11.0	36.0	1.80
A0221.9	—	1.90	0.0748	11.0	36.0	1.90
A0225/64	5/64	1.98	0.0781	17.0	43.0	1.98
A0222.0	—	2.00	0.0787	12.0	38.0	2.00
A0222.1	—	2.10	0.0827	12.0	38.0	2.10
A0222.2	—	2.20	0.0866	13.0	40.0	2.20

Product	DC [inch]	DC [mm]	DC [inch]	LCF [mm]	OAL [mm]	DCON MS [mm]
A0222.25	—	2.25	0.0886	13.0	40.0	2.25
A0222.3	—	2.30	0.0906	13.0	40.0	2.30
A0223/32	3/32	2.38	0.0938	20.0	45.0	2.38
A0222.4	—	2.40	0.0945	14.0	43.0	2.40
A0222.5	—	2.50	0.0984	14.0	43.0	2.50
A0222.6	—	2.60	0.1024	14.0	43.0	2.60
A0222.65	—	2.65	0.1043	14.0	43.0	2.65
A0222.7	—	2.70	0.1063	16.0	46.0	2.70
A0227/64	7/64	2.78	0.1094	22.0	47.0	2.78
A0222.8	—	2.80	0.1102	16.0	46.0	2.80
A0222.9	—	2.90	0.1142	16.0	46.0	2.90
A0223.0	—	3.00	0.1181	16.0	46.0	3.00
A0223.1	—	3.10	0.1220	18.0	49.0	3.10
A0221/8	1/8	3.18	0.1250	23.0	49.0	3.18
A0223.2	—	3.20	0.1260	18.0	49.0	3.20
A0223.25	—	3.25	0.1280	18.0	49.0	3.25
A0223.3	—	3.30	0.1299	18.0	49.0	3.30
A0223.4	—	3.40	0.1339	20.0	52.0	3.40
A0223.5	—	3.50	0.1378	20.0	52.0	3.50
A0229/64	9/64	3.57	0.1406	25.0	50.0	3.57
A0223.6	—	3.60	0.1417	20.0	52.0	3.60
A0223.7	—	3.70	0.1457	20.0	52.0	3.70



Product	DC	DC	DC	LCF	OAL	D CON MS
	[inch]	[mm]	[inch]	[mm]	[mm]	[mm]
A0223.8	–	3.80	0.1496	22.0	55.0	3.80
A0223.9	–	3.90	0.1535	22.0	55.0	3.90
A0225/32	5/32	3.97	0.1563	26.0	53.0	3.97
A0224.0	–	4.00	0.1575	22.0	55.0	4.00
A0224.1	–	4.10	0.1614	22.0	55.0	4.10
A0224.2	–	4.20	0.1654	22.0	55.0	4.20
A0224.3	–	4.30	0.1693	24.0	58.0	4.30
A02211/64	11/64	4.37	0.1719	28.0	55.0	4.37
A0224.4	–	4.40	0.1732	24.0	58.0	4.40
A0224.5	–	4.50	0.1772	24.0	58.0	4.50
A0224.6	–	4.60	0.1811	24.0	58.0	4.60
A0224.7	–	4.70	0.1850	24.0	58.0	4.70
A0223/16	3/16	4.76	0.1875	30.0	57.0	4.76
A0224.8	–	4.80	0.1890	26.0	62.0	4.80
A0224.9	–	4.90	0.1929	26.0	62.0	4.90
A0225.0	–	5.00	0.1969	26.0	62.0	5.00
A0225.1	–	5.10	0.2008	26.0	62.0	5.10
A02213/64	13/64	5.16	0.2031	31.0	58.0	5.16
A0225.2	–	5.20	0.2047	26.0	62.0	5.20
A0225.3	–	5.30	0.2087	26.0	62.0	5.30
A0225.4	–	5.40	0.2126	28.0	66.0	5.40
A0225.5	–	5.50	0.2165	28.0	66.0	5.50
A0227/32	7/32	5.56	0.2188	33.0	61.0	5.56
A0225.6	–	5.60	0.2205	28.0	66.0	5.60
A0225.7	–	5.70	0.2244	28.0	66.0	5.70
A0225.8	–	5.80	0.2283	28.0	66.0	5.80
A0225.9	–	5.90	0.2323	28.0	66.0	5.90
A02215/64	15/64	5.95	0.2344	34.0	63.0	5.95
A0226.0	–	6.00	0.2362	28.0	66.0	6.00
A0226.1	–	6.10	0.2402	31.0	70.0	6.10
A0226.2	–	6.20	0.2441	31.0	70.0	6.20
A0226.3	–	6.30	0.2480	31.0	70.0	6.30
A0221/4	1/4	6.35	0.2500	36.0	65.0	6.35
A0226.4	–	6.40	0.2520	31.0	70.0	6.40
A0226.5	–	6.50	0.2559	31.0	70.0	6.50
A0226.6	–	6.60	0.2598	31.0	70.0	6.60
A0226.7	–	6.70	0.2638	31.0	70.0	6.70
A0226.8	–	6.80	0.2677	34.0	74.0	6.80
A0226.9	–	6.90	0.2717	34.0	74.0	6.90
A0227.0	–	7.00	0.2756	34.0	74.0	7.00
A0227.1	–	7.10	0.2795	34.0	74.0	7.10
A0229/32	9/32	7.14	0.2813	40.0	70.0	7.14
A0227.2	–	7.20	0.2835	34.0	74.0	7.20
A0227.3	–	7.30	0.2874	34.0	74.0	7.30
A0227.4	–	7.40	0.2913	34.0	74.0	7.40
A0227.5	–	7.50	0.2953	34.0	74.0	7.50
A0227.6	–	7.60	0.2992	37.0	79.0	7.60
A0227.7	–	7.70	0.3031	37.0	79.0	7.70
A0227.8	–	7.80	0.3071	37.0	79.0	7.80
A0227.9	–	7.90	0.3110	37.0	79.0	7.90
A0225/16	5/16	7.94	0.3125	43.0	73.0	7.94
A0228.0	–	8.00	0.3150	37.0	79.0	8.00
A0228.1	–	8.10	0.3189	37.0	79.0	8.10
A0228.2	–	8.20	0.3228	37.0	79.0	8.20

Product	DC	DC	DC	LCF	OAL	D CON MS
	[inch]	[mm]	[inch]	[mm]	[mm]	[mm]
A0228.3	–	8.30	0.3268	37.0	79.0	8.30
A0228.4	–	8.40	0.3307	37.0	79.0	8.40
A0228.5	–	8.50	0.3346	37.0	79.0	8.50
A0228.6	–	8.60	0.3386	40.0	84.0	8.60
A0228.7	–	8.70	0.3425	40.0	84.0	8.70
A02211/32	11/32	8.73	0.3438	45.0	78.0	8.73
A0228.8	–	8.80	0.3465	40.0	84.0	8.80
A0228.9	–	8.90	0.3504	40.0	84.0	8.90
A0229.0	–	9.00	0.3543	40.0	84.0	9.00
A0229.1	–	9.10	0.3583	40.0	84.0	9.10
A0229.2	–	9.20	0.3622	40.0	84.0	9.20
A0229.3	–	9.30	0.3661	40.0	84.0	9.30
A0229.4	–	9.40	0.3701	40.0	84.0	9.40
A0229.5	–	9.50	0.3740	40.0	84.0	9.50
A0223/8	3/8	9.52	0.3750	48.0	81.0	9.52
A0229.6	–	9.60	0.3780	43.0	89.0	9.60
A0229.7	–	9.70	0.3819	43.0	89.0	9.70
A0229.8	–	9.80	0.3858	43.0	89.0	9.80
A0229.9	–	9.90	0.3898	43.0	89.0	9.90
A02210.0	–	10.00	0.3937	43.0	89.0	10.00
A02210.1	–	10.10	0.3976	43.0	89.0	10.10
A02210.2	–	10.20	0.4016	43.0	89.0	10.20
A02210.3	–	10.30	0.4055	43.0	89.0	10.30
A02213/32	13/32	10.32	0.4063	51.0	86.0	10.32
A02210.4	–	10.40	0.4094	43.0	89.0	10.40
A02210.5	–	10.50	0.4134	43.0	89.0	10.50
A02210.6	–	10.60	0.4173	43.0	89.0	10.60
A02210.7	–	10.70	0.4213	47.0	95.0	10.70
A02210.8	–	10.80	0.4252	47.0	95.0	10.80
A02210.9	–	10.90	0.4291	47.0	95.0	10.90
A02211.0	–	11.00	0.4331	47.0	95.0	11.00
A02211.1	–	11.10	0.4370	47.0	95.0	11.10
A0227/16	7/16	11.11	0.4375	54.0	89.0	11.11
A02211.2	–	11.20	0.4409	47.0	95.0	11.20
A02211.3	–	11.30	0.4449	47.0	95.0	11.30
A02211.5	–	11.50	0.4528	47.0	95.0	11.50
A02211.6	–	11.60	0.4567	47.0	95.0	11.60
A02211.7	–	11.70	0.4606	47.0	95.0	11.70
A02211.8	–	11.80	0.4646	47.0	95.0	11.80
A02211.9	–	11.90	0.4685	51.0	102.0	11.90
A02212.0	–	12.00	0.4724	51.0	102.0	12.00
A02212.1	–	12.10	0.4764	51.0	102.0	12.10
A02212.2	–	12.20	0.4803	51.0	102.0	12.20
A02212.5	–	12.50	0.4921	51.0	102.0	12.50
A0221/2	1/2	12.70	0.5000	60.0	98.0	12.70
A02213.0	–	13.00	0.5118	51.0	102.0	13.00
A02213.5	–	13.50	0.5315	54.0	107.0	13.50
A02214.0	–	14.00	0.5512	54.0	107.0	14.00
A0229/16	9/16	14.29	0.5625	67.0	105.0	14.29
A02214.5	–	14.50	0.5709	56.0	111.0	14.50
A02215.0	–	15.00	0.5906	56.0	111.0	15.00
A02215.5	–	15.50	0.6102	58.0	115.0	15.50
A0225/8	5/8	15.88	0.6250	73.0	111.0	15.88
A02216.0	–	16.00	0.6299	58.0	115.0	16.00



A620



HSS-E (5% Cobalt) Stub Drill, Bronze Tempered Finish

Drill with 130° point angle which helps self-centering and reduces the cutting forces. The bronze finish is a thin oxide layer and it is an indication for Cobalt. Suitable for drilling in many materials. Should not be used in hand-held devices.

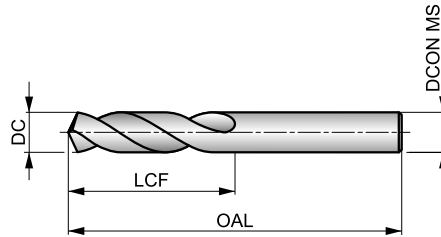

HSS-E	DIN 1897	2.5×D
130°	Bronze	
λ 20-35°	R	DC h8

Workpiece material group suitability, starting values for cutting speed (m/min) and feed Alpha Code. Tables with feed per revolution can be found starting from page 175.

P1.1 ▣40 H	P1.2 ▣45 H	P1.3 ▣46 H	P2.1 ▣34 H	P2.2 ▣30 G	P2.3 ▣27 F	P3.1 ▣27 G	P3.2 ▣21 G	P3.3 ▣18 F	P4.1 ▣16 G	P4.2 ▣13 F	P4.3 ▣11 E	M1.1 ▣30 F	M1.2 ▣26 F
M2.1 ▣27 F	M2.2 ▣22 F	M3.1 ▣13 H	M3.2 ▣11 H	M3.3 ▣10 H	M4.1 ▣15 D	K1.1 ▣34 K	K1.2 ▣25 F	K1.3 ▣19 F	K2.1 ▣27 F	K2.2 ▣22 F	K2.3 ▣18 F	K3.1 ▣24 F	K3.2 ▣18 F
K3.3 ▣15 F	K4.1 ▣22 F	K4.2 ▣17 F	K4.3 ▣12 F	K4.4 ▣11 F	K4.5 ▣9 F	K5.1 ▣25 F	K5.2 ▣19 F	K5.3 ▣15 F	N1.1 ▣40 K	N1.2 ▣30 K	N1.3 ▣20 J	N2.1 ▣49 I	N2.2 ▣44 I
N2.3 ▣32 I	N3.1 ▣68 J	N3.2 ▣40 K	N3.3 ▣20 I	N4.1 ▣40 L	N4.2 ▣32 K	N4.3 ▣18 I	S1.1 ▣30 G	S1.2 ▣18 F	S1.3 ▣10 C	S2.1 ▣12 F	S2.2 ▣8 C	S3.1 ▣9 F	S3.2 ▣6 C
S4.1 ▣7 F	S4.2 ▣5 C												

Product	DC	DC	LCF	OAL	DCON MS
	[mm]	[inch]			
A6202.5	2.50	0.0984	14.0	43.0	2.50
A6202.6	2.60	0.1024	14.0	43.0	2.60
A6202.7	2.70	0.1063	16.0	46.0	2.70
A6202.8	2.80	0.1102	16.0	46.0	2.80
A6202.9	2.90	0.1142	16.0	46.0	2.90
A6203.0	3.00	0.1181	16.0	46.0	3.00
A6203.1	3.10	0.1220	18.0	49.0	3.10
A6203.2	3.20	0.1260	18.0	49.0	3.20
A6203.3	3.30	0.1299	18.0	49.0	3.30
A6203.4	3.40	0.1339	20.0	52.0	3.40
A6203.5	3.50	0.1378	20.0	52.0	3.50
A6203.6	3.60	0.1417	20.0	52.0	3.60
A6203.7	3.70	0.1457	20.0	52.0	3.70
A6203.8	3.80	0.1496	22.0	55.0	3.80
A6203.9	3.90	0.1535	22.0	55.0	3.90
A6204.0	4.00	0.1575	22.0	55.0	4.00
A6204.1	4.10	0.1614	22.0	55.0	4.10
A6204.2	4.20	0.1654	22.0	55.0	4.20
A6204.3	4.30	0.1693	24.0	58.0	4.30
A6204.4	4.40	0.1732	24.0	58.0	4.40
A6204.5	4.50	0.1772	24.0	58.0	4.50
A6204.6	4.60	0.1811	24.0	58.0	4.60
A6204.7	4.70	0.1850	24.0	58.0	4.70
A6204.8	4.80	0.1890	26.0	62.0	4.80

Product	DC	DC	LCF	OAL	DCON MS
	[mm]	[inch]			
A6204.9	4.90	0.1929	26.0	62.0	4.90
A6205.0	5.00	0.1969	26.0	62.0	5.00
A6205.1	5.10	0.2008	26.0	62.0	5.10
A6205.2	5.20	0.2047	26.0	62.0	5.20
A6205.3	5.30	0.2087	26.0	62.0	5.30
A6205.4	5.40	0.2126	28.0	66.0	5.40
A6205.5	5.50	0.2165	28.0	66.0	5.50
A6205.6	5.60	0.2205	28.0	66.0	5.60
A6205.7	5.70	0.2244	28.0	66.0	5.70
A6205.8	5.80	0.2283	28.0	66.0	5.80
A6205.9	5.90	0.2323	28.0	66.0	5.90
A6206.0	6.00	0.2362	28.0	66.0	6.00
A6206.1	6.10	0.2402	31.0	70.0	6.10
A6206.2	6.20	0.2441	31.0	70.0	6.20
A6206.3	6.30	0.2480	31.0	70.0	6.30
A6206.4	6.40	0.2520	31.0	70.0	6.40
A6206.5	6.50	0.2559	31.0	70.0	6.50
A6206.6	6.60	0.2598	31.0	70.0	6.60
A6206.7	6.70	0.2638	31.0	70.0	6.70
A6206.8	6.80	0.2677	34.0	74.0	6.80
A6206.9	6.90	0.2717	34.0	74.0	6.90
A6207.0	7.00	0.2756	34.0	74.0	7.00
A6207.1	7.10	0.2795	34.0	74.0	7.10
A6207.2	7.20	0.2835	34.0	74.0	7.20



Product	DC	DC	LCF	OAL	DCON MS
	[mm]	[inch]	[mm]	[mm]	[mm]
A6207.3	7.30	0.2874	34.0	74.0	7.30
A6207.4	7.40	0.2913	34.0	74.0	7.40
A6207.5	7.50	0.2953	34.0	74.0	7.50
A6207.6	7.60	0.2992	37.0	79.0	7.60
A6207.7	7.70	0.3031	37.0	79.0	7.70
A6207.8	7.80	0.3071	37.0	79.0	7.80
A6207.9	7.90	0.3110	37.0	79.0	7.90
A6208.0	8.00	0.3150	37.0	79.0	8.00
A6208.1	8.10	0.3189	37.0	79.0	8.10
A6208.2	8.20	0.3228	37.0	79.0	8.20
A6208.3	8.30	0.3268	37.0	79.0	8.30
A6208.4	8.40	0.3307	37.0	79.0	8.40
A6208.5	8.50	0.3346	37.0	79.0	8.50
A6208.6	8.60	0.3386	40.0	84.0	8.60
A6208.7	8.70	0.3425	40.0	84.0	8.70
A6208.8	8.80	0.3465	40.0	84.0	8.80
A6208.9	8.90	0.3504	40.0	84.0	8.90
A6209.0	9.00	0.3543	40.0	84.0	9.00
A6209.1	9.10	0.3583	40.0	84.0	9.10
A6209.2	9.20	0.3622	40.0	84.0	9.20

Product	DC	DC	LCF	OAL	DCON MS
	[mm]	[inch]	[mm]	[mm]	[mm]
A6209.3	9.30	0.3661	40.0	84.0	9.30
A6209.4	9.40	0.3701	40.0	84.0	9.40
A6209.5	9.50	0.3740	40.0	84.0	9.50
A6209.6	9.60	0.3780	43.0	89.0	9.60
A6209.7	9.70	0.3819	43.0	89.0	9.70
A6209.8	9.80	0.3858	43.0	89.0	9.80
A6209.9	9.90	0.3898	43.0	89.0	9.90
A62010.0	10.00	0.3937	43.0	89.0	10.00
A62010.2	10.20	0.4016	43.0	89.0	10.20
A62010.3	10.30	0.4055	43.0	89.0	10.30
A62010.4	10.40	0.4094	43.0	89.0	10.40
A62010.5	10.50	0.4134	43.0	89.0	10.50
A62010.8	10.80	0.4252	47.0	95.0	10.80
A62011.0	11.00	0.4331	47.0	95.0	11.00
A62011.5	11.50	0.4528	47.0	95.0	11.50
A62012.0	12.00	0.4724	51.0	102.0	12.00
A62012.2	12.20	0.4803	51.0	102.0	12.20
A62012.5	12.50	0.4921	51.0	102.0	12.50
A62012.8	12.80	0.5039	51.0	102.0	12.80
A62013.0	13.00	0.5118	51.0	102.0	13.00



A117



HSS-E (5% Cobalt) Stub Drill, Bronze Tempered Finish

Drill recommended for use in difficult materials and applications. A 135° split point makes self-centering easier and also reduces the cutting forces. Can be relied on to produce a precise hole and quality finish. The bronze finish is a thin oxide layer and it is an indication for Cobalt.

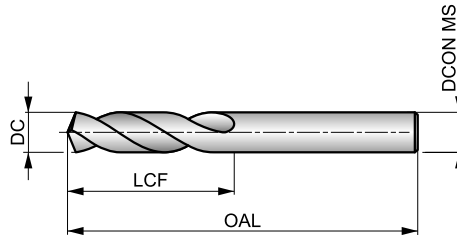

HSS-E	DIN 1897	2.5×D
135°	Bronze	
λ 20-35°	R	DC h8

Workpiece material group suitability, starting values for cutting speed (m/min) and feed Alpha Code. Tables with feed per revolution can be found starting from page 175.

P1.1 ■ 40 H	P1.2 ■ 45 H	P1.3 ■ 46 H	P2.1 ■ 34 H	P2.2 ■ 30 G	P2.3 ■ 27 F	P3.1 ■ 27 G	P3.2 ■ 21 G	P3.3 ■ 18 F	P4.1 ■ 16 G	P4.2 ■ 13 F	P4.3 ■ 11 E	M1.1 ■ 30 F	M1.2 ■ 26 F
M2.1 ■ 27 F	M2.2 ■ 22 F	M3.1 ■ 13 H	M3.2 ■ 11 H	M3.3 ■ 10 H	M4.1 ■ 15 D	K1.1 ■ 34 K	K1.2 ■ 25 F	K1.3 ■ 19 F	K2.1 ■ 27 F	K2.2 ■ 22 F	K2.3 ■ 18 F	K3.1 ■ 24 F	K3.2 ■ 18 F
K3.3 ■ 15 F	K4.1 ■ 22 F	K4.2 ■ 17 F	K4.3 ■ 12 F	K4.4 ■ 11 F	K4.5 ■ 9 F	K5.1 ■ 25 F	K5.2 ■ 19 F	K5.3 ■ 15 F	N1.1 ■ 35 K	N1.2 ■ 26 K	N1.3 ■ 18 J	N2.1 ■ 48 I	N2.2 ■ 43 I
N2.3 ■ 31 I	N3.1 ■ 68 J	N3.2 ■ 40 K	N3.3 ■ 20 I	N4.1 ■ 35 M	N4.2 ■ 28 K	N4.3 ■ 17 I	S1.1 ■ 30 G	S1.2 ■ 18 F	S1.3 ■ 10 C	S2.1 ■ 12 F	S2.2 ■ 8 C	S3.1 ■ 9 F	S3.2 ■ 6 C
S4.1 ■ 7 F	S4.2 ■ 5 C												

DC ≤ 1.5mm 118° point.

Product	DC	DC	DC	LCF	OAL	DCON MS
	[inch]	[mm]	[inch]	[mm]	[mm]	[mm]
A1171.0	–	1.00	0.0394	6.0	26.0	1.00
A1171.1	–	1.10	0.0433	7.0	28.0	1.10
A1171.2	–	1.20	0.0472	8.0	30.0	1.20
A1171.3	–	1.30	0.0512	8.0	30.0	1.30
A1171.4	–	1.40	0.0551	9.0	32.0	1.40
A1171.5	–	1.50	0.0591	9.0	32.0	1.50
A1171.6	–	1.60	0.0630	10.0	34.0	1.60
A1171.7	–	1.70	0.0669	10.0	34.0	1.70
A1171.8	–	1.80	0.0709	11.0	36.0	1.80
A1171.9	–	1.90	0.0748	11.0	36.0	1.90
A1172.0	–	2.00	0.0787	12.0	38.0	2.00
A1172.1	–	2.10	0.0827	12.0	38.0	2.10
A1172.2	–	2.20	0.0866	13.0	40.0	2.20
A1172.3	–	2.30	0.0906	13.0	40.0	2.30
A1172.4	–	2.40	0.0945	14.0	43.0	2.40
A1172.5	–	2.50	0.0984	14.0	43.0	2.50
A1172.6	–	2.60	0.1024	14.0	43.0	2.60
A1172.7	–	2.70	0.1063	16.0	46.0	2.70
A1172.8	–	2.80	0.1102	16.0	46.0	2.80
A1172.9	–	2.90	0.1142	16.0	46.0	2.90
A1173.0	–	3.00	0.1181	16.0	46.0	3.00
A1173.1	–	3.10	0.1220	18.0	49.0	3.10
A1171/8	1/8	3.18	0.1250	18.0	49.0	3.18

Product	DC	DC	DC	LCF	OAL	DCON MS
	[inch]	[mm]	[inch]	[mm]	[mm]	[mm]
A1173.2	–	3.20	0.1260	18.0	49.0	3.20
A1173.3	–	3.30	0.1299	18.0	49.0	3.30
A1173.4	–	3.40	0.1339	20.0	52.0	3.40
A1173.5	–	3.50	0.1378	20.0	52.0	3.50
A1173.6	–	3.60	0.1417	20.0	52.0	3.60
A1173.7	–	3.70	0.1457	20.0	52.0	3.70
A1173.8	–	3.80	0.1496	22.0	55.0	3.80
A1173.9	–	3.90	0.1535	22.0	55.0	3.90
A1175/32	5/32	3.97	0.1563	22.0	55.0	3.97
A1174.0	–	4.00	0.1575	22.0	55.0	4.00
A1174.1	–	4.10	0.1614	22.0	55.0	4.10
A1174.2	–	4.20	0.1654	22.0	55.0	4.20
A1174.3	–	4.30	0.1693	24.0	58.0	4.30
A1174.4	–	4.40	0.1732	24.0	58.0	4.40
A1174.5	–	4.50	0.1772	24.0	58.0	4.50
A1174.6	–	4.60	0.1811	24.0	58.0	4.60
A1174.7	–	4.70	0.1850	24.0	58.0	4.70
A1173/16	3/16	4.76	0.1875	26.0	62.0	4.76
A1174.8	–	4.80	0.1890	26.0	62.0	4.80
A1174.9	–	4.90	0.1929	26.0	62.0	4.90
A1175.0	–	5.00	0.1969	26.0	62.0	5.00
A1175.1	–	5.10	0.2008	26.0	62.0	5.10
A1175.2	–	5.20	0.2047	26.0	62.0	5.20



Product	DC	DC	DC	LCF	OAL	DCON MS
	[inch]	[mm]	[inch]	[mm]	[mm]	[mm]
A1175.3	–	5.30	0.2087	26.0	62.0	5.30
A1175.4	–	5.40	0.2126	28.0	66.0	5.40
A1175.5	–	5.50	0.2165	28.0	66.0	5.50
A1175.6	–	5.60	0.2205	28.0	66.0	5.60
A1175.7	–	5.70	0.2244	28.0	66.0	5.70
A1175.8	–	5.80	0.2283	28.0	66.0	5.80
A1175.9	–	5.90	0.2323	28.0	66.0	5.90
A1176.0	–	6.00	0.2362	28.0	66.0	6.00
A1176.1	–	6.10	0.2402	31.0	70.0	6.10
A1176.2	–	6.20	0.2441	31.0	70.0	6.20
A1176.3	–	6.30	0.2480	31.0	70.0	6.30
A1171/4	1/4	6.35	0.2500	31.0	70.0	6.35
A1176.4	–	6.40	0.2520	31.0	70.0	6.40
A1176.5	–	6.50	0.2559	31.0	70.0	6.50
A1176.6	–	6.60	0.2598	31.0	70.0	6.60
A1176.7	–	6.70	0.2638	31.0	70.0	6.70
A1176.8	–	6.80	0.2677	34.0	74.0	6.80
A1176.9	–	6.90	0.2717	34.0	74.0	6.90
A1177.0	–	7.00	0.2756	34.0	74.0	7.00
A1177.1	–	7.10	0.2795	34.0	74.0	7.10
A1177.2	–	7.20	0.2835	34.0	74.0	7.20
A1177.3	–	7.30	0.2874	34.0	74.0	7.30
A1177.4	–	7.40	0.2913	34.0	74.0	7.40
A1177.5	–	7.50	0.2953	34.0	74.0	7.50
A1177.6	–	7.60	0.2992	37.0	79.0	7.60
A1177.7	–	7.70	0.3031	37.0	79.0	7.70
A1177.8	–	7.80	0.3071	37.0	79.0	7.80
A1177.9	–	7.90	0.3110	37.0	79.0	7.90
A1175/16	5/16	7.94	0.3125	37.0	79.0	7.94

Product	DC	DC	DC	LCF	OAL	DCON MS
	[inch]	[mm]	[inch]	[mm]	[mm]	[mm]
A1178.0	–	8.00	0.3150	37.0	79.0	8.00
A1178.1	–	8.10	0.3189	37.0	79.0	8.10
A1178.2	–	8.20	0.3228	37.0	79.0	8.20
A1178.3	–	8.30	0.3268	37.0	79.0	8.30
A1178.4	–	8.40	0.3307	37.0	79.0	8.40
A1178.5	–	8.50	0.3346	37.0	79.0	8.50
A1178.6	–	8.60	0.3386	40.0	84.0	8.60
A1178.7	–	8.70	0.3425	40.0	84.0	8.70
A1178.8	–	8.80	0.3465	40.0	84.0	8.80
A1178.9	–	8.90	0.3504	40.0	84.0	8.90
A1179.0	–	9.00	0.3543	40.0	84.0	9.00
A1179.1	–	9.10	0.3583	40.0	84.0	9.10
A1179.2	–	9.20	0.3622	40.0	84.0	9.20
A1179.3	–	9.30	0.3661	40.0	84.0	9.30
A1179.4	–	9.40	0.3701	40.0	84.0	9.40
A1179.5	–	9.50	0.3740	40.0	84.0	9.50
A1173/8	3/8	9.52	0.3750	43.0	89.0	9.52
A1179.6	–	9.60	0.3780	43.0	89.0	9.60
A1179.7	–	9.70	0.3819	43.0	89.0	9.70
A1179.8	–	9.80	0.3858	43.0	89.0	9.80
A1179.9	–	9.90	0.3898	43.0	89.0	9.90
A11710.0	–	10.00	0.3937	43.0	89.0	10.00
A11710.2	–	10.20	0.4016	43.0	89.0	10.20
A11710.5	–	10.50	0.4134	43.0	89.0	10.50
A11711.0	–	11.00	0.4331	47.0	95.0	11.00
A11711.5	–	11.50	0.4528	47.0	95.0	11.50
A11712.0	–	12.00	0.4724	51.0	102.0	12.00
A1171/2	1/2	12.70	0.5000	51.0	102.0	12.70
A11713.0	–	13.00	0.5118	51.0	102.0	13.00



A520



ADX HSS Stub Drill, TiN Coated

High performance drill, able to produce high quality and accurate holes at high speeds and feeds (H9 hole tolerance). A 130° thinned point which helps with self-centering and reduces cutting forces. This drill should be used in machines with constant feed only. TiN coating extends the tool life.

ADX

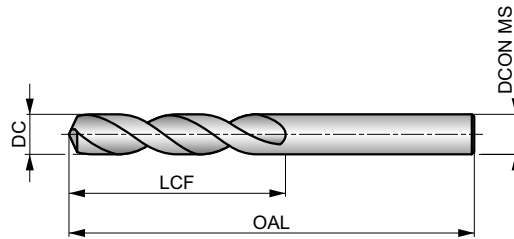

HSS	DIN 1897	2.5×D
130°	TiN	
λ 32-40°	R	DC h8

Workpiece material group suitability, starting values for cutting speed (m/min) and feed Alpha Code. Tables with feed per revolution can be found starting from page 175.

P1.1 ■ 53 M	P1.2 ■ 59 M	P1.3 ■ 61 M	P2.1 ■ 45 M	P2.2 ■ 40 K	P2.3 ■ 35 G	P3.1 ■ 31 I	P3.2 ■ 25 I	P3.3 ■ 21 G	P4.1 ■ 19 I	P4.2 ■ 16 G	P4.3 ■ 13 E	M1.1 ■ 41 I	M1.2 ■ 35 I
M2.1 ■ 37 I	M2.2 ■ 30 I	M3.1 ■ 19 I	M3.2 ■ 16 I	M3.3 ■ 14 I	M4.1 ■ 20 G	K1.1 ■ 48 M	K1.2 ■ 36 K	K1.3 ■ 27 K	K2.1 ■ 37 J	K2.2 ■ 30 J	K2.3 ■ 24 F	K3.1 ■ 33 J	K3.2 ■ 25 J
K3.3 ■ 20 F	K4.1 ■ 30 J	K4.2 ■ 23 J	K4.3 ■ 17 F	K4.4 ■ 14 F	K4.5 ■ 12 F	K5.1 ■ 34 J	K5.2 ■ 26 J	K5.3 ■ 20 F	N1.1 ■ 55 I	N1.2 ■ 41 I	N1.3 ■ 28 M	N2.1 ■ 57 K	N2.2 ■ 51 K
N2.3 ■ 37 K	N3.1 ■ 85 K	N3.2 ■ 50 I	N3.3 ■ 25 E	N4.1 ■ 65 G	N4.2 ■ 50 G	N4.3 ■ 35 F	S1.1 ■ 34 I	S1.2 ■ 20 G	S1.3 ■ 4 B	S2.1 ■ 15 G	S2.2 ■ 10 E	S3.1 ■ 11 G	S3.2 ■ 7 E
S4.1 ■ 9 G	S4.2 ■ 6 E												

Product	DC [inch]	DC [mm]	DC [inch]	LCF [mm]	OAL [mm]	DCON MS [mm]
A5203.0	–	3.00	0.1181	16.0	46.0	3.00
A5203.1	–	3.10	0.1220	18.0	49.0	3.10
A5201/8	1/8	3.18	0.1250	18.0	49.0	3.18
A5203.2	–	3.20	0.1260	18.0	49.0	3.20
A5203.3	–	3.30	0.1299	18.0	49.0	3.30
A5203.4	–	3.40	0.1339	20.0	52.0	3.40
A5203.5	–	3.50	0.1378	20.0	52.0	3.50
A5209/64	9/64	3.57	0.1406	20.0	52.0	3.57
A5203.6	–	3.60	0.1417	20.0	52.0	3.60
A5203.7	–	3.70	0.1457	20.0	52.0	3.70
A5203.8	–	3.80	0.1496	22.0	55.0	3.80
A5203.9	–	3.90	0.1535	22.0	55.0	3.90
A5205/32	5/32	3.97	0.1563	22.0	55.0	3.97
A5204.0	–	4.00	0.1575	22.0	55.0	4.00
A5204.1	–	4.10	0.1614	22.0	55.0	4.10
A5204.2	–	4.20	0.1654	22.0	55.0	4.20
A5204.3	–	4.30	0.1693	24.0	58.0	4.30
A52011/64	11/64	4.37	0.1719	24.0	58.0	4.37
A5204.4	–	4.40	0.1732	24.0	58.0	4.40
A5204.5	–	4.50	0.1772	24.0	58.0	4.50
A5204.6	–	4.60	0.1811	24.0	58.0	4.60
A5204.7	–	4.70	0.1850	24.0	58.0	4.70
A5203/16	3/16	4.76	0.1875	26.0	62.0	4.76
A5204.8	–	4.80	0.1890	26.0	62.0	4.80

Product	DC [inch]	DC [mm]	DC [inch]	LCF [mm]	OAL [mm]	DCON MS [mm]
A5204.9	–	4.90	0.1929	26.0	62.0	4.90
A5205.0	–	5.00	0.1969	26.0	62.0	5.00
A5205.1	–	5.10	0.2008	26.0	62.0	5.10
A52013/64	13/64	5.16	0.2031	26.0	62.0	5.16
A5205.2	–	5.20	0.2047	26.0	62.0	5.20
A5205.3	–	5.30	0.2087	26.0	62.0	5.30
A5205.4	–	5.40	0.2126	28.0	66.0	5.40
A5205.5	–	5.50	0.2165	28.0	66.0	5.50
A5207/32	7/32	5.56	0.2188	28.0	66.0	5.56
A5205.6	–	5.60	0.2205	28.0	66.0	5.60
A5205.7	–	5.70	0.2244	28.0	66.0	5.70
A5205.8	–	5.80	0.2283	28.0	66.0	5.80
A5205.9	–	5.90	0.2323	28.0	66.0	5.90
A52015/64	15/64	5.95	0.2344	28.0	66.0	5.95
A5206.0	–	6.00	0.2362	28.0	66.0	6.00
A5206.1	–	6.10	0.2402	31.0	70.0	6.10
A5206.2	–	6.20	0.2441	31.0	70.0	6.20
A5206.3	–	6.30	0.2480	31.0	70.0	6.30
A5201/4	1/4	6.35	0.2500	31.0	70.0	6.35
A5206.4	–	6.40	0.2520	31.0	70.0	6.40
A5206.5	–	6.50	0.2559	31.0	70.0	6.50
A5206.6	–	6.60	0.2598	31.0	70.0	6.60
A5206.7	–	6.70	0.2638	31.0	70.0	6.70
A52017/64	17/64	6.75	0.2656	34.0	74.0	6.75



Product	DC	DC	DC	LCF	OAL	D CON MS
	[inch]	[mm]	[inch]	[mm]	[mm]	[mm]
A5206.8	–	6.80	0.2677	34.0	74.0	6.80
A5206.9	–	6.90	0.2717	34.0	74.0	6.90
A5207.0	–	7.00	0.2756	34.0	74.0	7.00
A5207.1	–	7.10	0.2795	34.0	74.0	7.10
A5209/32	9/32	7.14	0.2813	34.0	74.0	7.14
A5207.2	–	7.20	0.2835	34.0	74.0	7.20
A5207.3	–	7.30	0.2874	34.0	74.0	7.30
A5207.4	–	7.40	0.2913	34.0	74.0	7.40
A5207.5	–	7.50	0.2953	34.0	74.0	7.50
A52019/64	19/64	7.54	0.2969	37.0	79.0	7.54
A5207.6	–	7.60	0.2992	37.0	79.0	7.60
A5207.7	–	7.70	0.3031	37.0	79.0	7.70
A5207.8	–	7.80	0.3071	37.0	79.0	7.80
A5207.9	–	7.90	0.3110	37.0	79.0	7.90
A5205/16	5/16	7.94	0.3125	37.0	79.0	7.94
A5208.0	–	8.00	0.3150	37.0	79.0	8.00
A5208.1	–	8.10	0.3189	37.0	79.0	8.10
A5208.2	–	8.20	0.3228	37.0	79.0	8.20
A5208.3	–	8.30	0.3268	37.0	79.0	8.30
A52021/64	21/64	8.33	0.3281	37.0	79.0	8.33
A5208.4	–	8.40	0.3307	37.0	79.0	8.40
A5208.5	–	8.50	0.3346	37.0	79.0	8.50
A5208.6	–	8.60	0.3386	40.0	84.0	8.60
A5208.7	–	8.70	0.3425	40.0	84.0	8.70
A52011/32	11/32	8.73	0.3438	40.0	84.0	8.73
A5208.8	–	8.80	0.3465	40.0	84.0	8.80
A5208.9	–	8.90	0.3504	40.0	84.0	8.90
A5209.0	–	9.00	0.3543	40.0	84.0	9.00
A5209.1	–	9.10	0.3583	40.0	84.0	9.10
A52023/64	23/64	9.13	0.3594	40.0	84.0	9.13
A5209.2	–	9.20	0.3622	40.0	84.0	9.20
A5209.3	–	9.30	0.3661	40.0	84.0	9.30
A5209.4	–	9.40	0.3701	40.0	84.0	9.40
A5209.5	–	9.50	0.3740	40.0	84.0	9.50
A5203/8	3/8	9.52	0.3750	43.0	89.0	9.52
A5209.6	–	9.60	0.3780	43.0	89.0	9.60
A5209.7	–	9.70	0.3819	43.0	89.0	9.70
A5209.8	–	9.80	0.3858	43.0	89.0	9.80
A5209.9	–	9.90	0.3898	43.0	89.0	9.90

Product	DC	DC	DC	LCF	OAL	D CON MS
	[inch]	[mm]	[inch]	[mm]	[mm]	[mm]
A52025/64	25/64	9.92	0.3906	43.0	89.0	9.92
A52010.0	–	10.00	0.3937	43.0	89.0	10.00
A52010.1	–	10.10	0.3976	43.0	89.0	10.10
A52010.2	–	10.20	0.4016	43.0	89.0	10.20
A52010.3	–	10.30	0.4055	43.0	89.0	10.30
A52013/32	13/32	10.32	0.4063	43.0	89.0	10.32
A52010.4	–	10.40	0.4094	43.0	89.0	10.40
A52010.5	–	10.50	0.4134	43.0	89.0	10.50
A52010.6	–	10.60	0.4173	43.0	89.0	10.60
A52010.7	–	10.70	0.4213	47.0	95.0	10.70
A52027/64	27/64	10.72	0.4219	47.0	95.0	10.72
A52010.8	–	10.80	0.4252	47.0	95.0	10.80
A52010.9	–	10.90	0.4291	47.0	95.0	10.90
A52011.0	–	11.00	0.4331	47.0	95.0	11.00
A52011.1	–	11.10	0.4370	47.0	95.0	11.10
A5207/16	7/16	11.11	0.4375	47.0	95.0	11.11
A52011.2	–	11.20	0.4409	47.0	95.0	11.20
A52011.3	–	11.30	0.4449	47.0	95.0	11.30
A52011.4	–	11.40	0.4488	47.0	95.0	11.40
A52011.5	–	11.50	0.4528	47.0	95.0	11.50
A52029/64	29/64	11.51	0.4531	47.0	95.0	11.51
A52011.6	–	11.60	0.4567	47.0	95.0	11.60
A52011.7	–	11.70	0.4606	47.0	95.0	11.70
A52011.8	–	11.80	0.4646	47.0	95.0	11.80
A52011.9	–	11.90	0.4685	51.0	102.0	11.90
A52015/32	15/32	11.91	0.4688	51.0	102.0	11.91
A52012.0	–	12.00	0.4724	51.0	102.0	12.00
A52012.1	–	12.10	0.4764	51.0	102.0	12.10
A52012.2	–	12.20	0.4803	51.0	102.0	12.20
A52012.3	–	12.30	0.4843	51.0	102.0	12.30
A52031/64	31/64	12.30	0.4844	51.0	102.0	12.30
A52012.4	–	12.40	0.4882	51.0	102.0	12.40
A52012.5	–	12.50	0.4921	51.0	102.0	12.50
A52012.6	–	12.60	0.4961	51.0	102.0	12.60
A52012.7	–	12.70	0.5000	51.0	102.0	12.70
A5201/2	1/2	12.70	0.5000	51.0	102.0	12.70
A52012.8	–	12.80	0.5039	51.0	102.0	12.80
A52012.9	–	12.90	0.5079	51.0	102.0	12.90
A52013.0	–	13.00	0.5118	51.0	102.0	13.00



A124



HSS Stub Drill, Steam Tempered Finish, with Brazed Carbide Point

Brazed carbide tip gives the high performance of a carbide drill with a strong and less brittle HSS body. A 118°, 4-facet point, helps with self-centering making it an economical choice. It can be used in both conventional and CNC machines. Steam tempered finish retains cutting fluid.

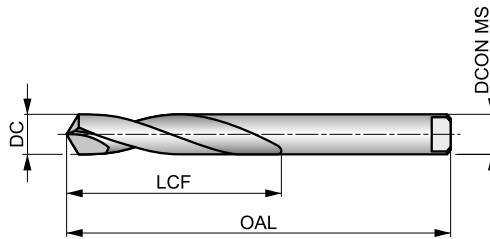

HSS HM	DIN 8037	2.5×D
118°	Bright ST	
λ 10-20°		

Workpiece material group suitability, starting values for cutting speed (m/min) and feed Alpha Code. Tables with feed per revolution can be found starting from page 175.

P2.3 ■ 40 C	P3.3 ■ 40 C	P4.2 ■ 30 C	P4.3 ■ 24 A	M3.1 ■ 41 C	M3.2 ■ 35 C	M3.3 ■ 32 C	M4.1 ■ 35 C	K1.1 ■ 55 C	K1.2 ■ 41 C	K1.3 ■ 31 C	K2.1 ■ 49 C	K2.2 ■ 40 C	K2.3 ■ 32 A
K3.1 ■ 44 C	K3.2 ■ 33 C	K3.3 ■ 27 A	K4.1 ■ 40 C	K4.2 ■ 30 C	K4.3 ■ 22 A	K4.4 ■ 19 A	K4.5 ■ 16 A	K5.1 ■ 46 C	K5.2 ■ 34 C	K5.3 ■ 27 A	N3.1 ■ 119 E	N3.2 ■ 170 G	N4.2 ■ 60 E
S1.1 ■ 40 A	S1.2 ■ 35 A	S1.3 ■ 25 A	S2.1 ■ 33 A	S2.2 ■ 28 A	S3.1 ■ 25 A	S3.2 ■ 20 A	S4.1 ■ 20 A	S4.2 ■ 16 A					

Tang to DIN 1809.

Product	DC	DC	LCF	OAL	DCON MS
	[mm]	[inch]			
A1243.0	3.00	0.1181	20.0	50.0	3.00
A1243.2	3.20	0.1260	25.0	56.0	3.20
A1243.5	3.50	0.1378	25.0	56.0	3.50
A1244.0	4.00	0.1575	25.0	56.0	4.00
A1244.2	4.20	0.1654	28.0	63.0	4.20
A1244.5	4.50	0.1772	28.0	63.0	4.50
A1244.8	4.80	0.1890	28.0	63.0	4.80
A1245.0	5.00	0.1969	28.0	63.0	5.00
A1245.2	5.20	0.2047	32.0	71.0	5.20
A1245.5	5.50	0.2165	32.0	71.0	5.50
A1245.8	5.80	0.2283	32.0	71.0	5.80
A1246.0	6.00	0.2362	32.0	71.0	6.00
A1246.5	6.50	0.2559	32.0	71.0	6.50
A1246.8	6.80	0.2677	40.0	80.0	6.80
A1247.0	7.00	0.2756	40.0	80.0	7.00

Product	DC	DC	LCF	OAL	DCON MS
	[mm]	[inch]			
A1247.5	7.50	0.2953	40.0	80.0	7.50
A1248.0	8.00	0.3150	40.0	80.0	8.00
A1248.5	8.50	0.3346	50.0	90.0	8.50
A1249.0	9.00	0.3543	50.0	90.0	9.00
A1249.5	9.50	0.3740	50.0	90.0	9.50
A12410.0	10.00	0.3937	56.0	100.0	10.00
A12410.5	10.50	0.4134	56.0	100.0	10.50
A12411.0	11.00	0.4331	56.0	100.0	11.00
A12411.5	11.50	0.4528	63.0	112.0	11.50
A12412.0	12.00	0.4724	63.0	112.0	12.00
A12413.0	13.00	0.5118	63.0	112.0	13.00
A12414.0	14.00	0.5512	71.0	125.0	14.00
A12415.0	15.00	0.5906	71.0	125.0	15.00
A12416.0	16.00	0.6299	80.0	140.0	16.00



A720



HSS-E (5% Cobalt) Micro Drill, Bright Finish

Micro drill in very small diameters ranging from 0.15 mm to 1.40 mm. To make tool holding easier, all drills have either a 1.00 mm or 1.50 mm shank diameter. The drills all have a 118°, 4-facet point which is a great aid to self-centering and reduces the cutting forces.

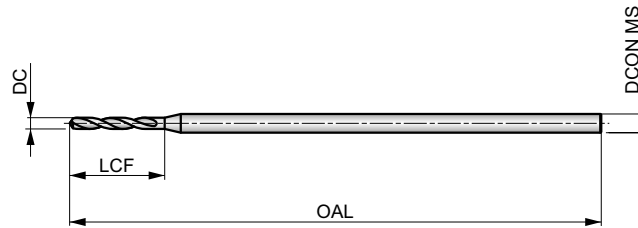

HSS-E	DIN 1899	2.5×D
118°	Bright	
λ 20-35°	R	

Workpiece material group suitability, starting values for cutting speed (m/min) and feed Alpha Code. Tables with feed per revolution can be found starting from page 175.

P1.1 ■ 36 A	P1.2 ■ 40 A	P1.3 ■ 41 A	P2.1 ■ 31 A	P2.2 ■ 27 A	P2.3 ■ 24 A	P3.1 ■ 25 A	P3.2 ■ 20 A	P3.3 ■ 17 A	P4.1 ■ 15 A	P4.2 ■ 13 A	P4.3 ■ 10 A	M1.1 ■ 30 A	M1.2 ■ 26 A
M2.1 ■ 27 A	M2.2 ■ 22 A	M3.1 ■ 12 A	M3.2 ■ 10 A	M3.3 ■ 9 A	M4.1 ■ 15 A	K1.1 ■ 30 A	K1.2 ■ 22 A	K1.3 ■ 17 A	K2.1 ■ 25 A	K2.2 ■ 20 A	K2.3 ■ 16 A	K3.1 ■ 22 A	K3.2 ■ 17 A
K3.3 ■ 13 A	K4.1 ■ 20 A	K4.2 ■ 15 A	K4.3 ■ 11 A	K4.4 ■ 10 A	K4.5 ■ 8 A	K5.1 ■ 23 A	K5.2 ■ 17 A	K5.3 ■ 13 A	N1.1 ■ 35 A	N1.2 ■ 26 A	N1.3 ■ 18 A	N2.1 ■ 42 A	N2.2 ■ 37 A
N2.3 ■ 27 A	N3.1 ■ 68 A	N3.2 ■ 40 A	N3.3 ■ 20 A	N4.1 ■ 48 A	N4.2 ■ 25 A	S1.1 ■ 23 A	S1.2 ■ 17 A	S1.3 ■ 8 A	S2.1 ■ 9 A	S2.2 ■ 6 A	S3.1 ■ 7 A	S3.2 ■ 4 A	S4.1 ■ 5 A
S4.2 ■ 3 A													

Product	DC [mm]	DC [inch]	LCF [mm]	OAL [mm]	DCON MS [mm]	Product	DC [mm]	DC [inch]	LCF [mm]	OAL [mm]	DCON MS [mm]
A720.15	0.15	0.0059	1.0	25.0	1.00	A720.55	0.55	0.0217	4.5	25.0	1.00
A720.16	0.16	0.0063	1.4	25.0	1.00	A720.6	0.60	0.0236	4.5	25.0	1.00
A720.17	0.17	0.0067	1.4	25.0	1.00	A720.62	0.62	0.0244	5.0	25.0	1.00
A720.18	0.18	0.0070	1.4	25.0	1.00	A720.65	0.65	0.0256	5.0	25.0	1.00
A720.2	0.20	0.0079	1.8	25.0	1.00	A720.7	0.70	0.0276	5.6	25.0	1.00
A720.22	0.22	0.0087	1.8	25.0	1.00	A720.75	0.75	0.0295	5.6	25.0	1.00
A720.25	0.25	0.0098	2.2	25.0	1.00	A720.8	0.80	0.0315	6.3	25.0	1.50
A720.27	0.27	0.0106	2.2	25.0	1.00	A720.85	0.85	0.0335	6.3	25.0	1.50
A720.28	0.28	0.0110	2.2	25.0	1.00	A720.9	0.90	0.0354	7.1	25.0	1.50
A720.3	0.30	0.0118	2.2	25.0	1.00	A720.95	0.95	0.0374	7.1	25.0	1.50
A720.35	0.35	0.0138	2.8	25.0	1.00	A7201.0	1.00	0.0394	8.0	25.0	1.50
A720.38	0.38	0.0150	2.8	25.0	1.00	A7201.05	1.05	0.0413	8.0	25.0	1.50
A720.39	0.39	0.0154	3.6	25.0	1.00	A7201.1	1.10	0.0433	9.0	25.0	1.50
A720.4	0.40	0.0157	3.6	25.0	1.00	A7201.2	1.20	0.0472	10.0	25.0	1.50
A720.45	0.45	0.0177	3.6	25.0	1.00	A7201.3	1.30	0.0512	10.0	25.0	1.50
A720.5	0.50	0.0197	4.0	25.0	1.00	A7201.4	1.40	0.0551	11.2	25.0	1.50



A920



PFX HSS-E (5% Cobalt) Stub Drill, Bright Finish

High performance drill, able to produce high quality and accurate holes at high speeds and feeds (H10 hole tolerance). Self-centering 130° point angle and special parabolic flute design help to drill deep holes in a single pass. Suitable for many materials.



PFX

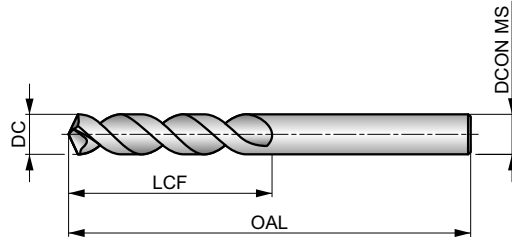

HSS-E	DIN ANSI	3xD
130°	Bright	
$\lambda > 35^\circ$	R	DC h8

Workpiece material group suitability, starting values for cutting speed (m/min) and feed Alpha Code. Tables with feed per revolution can be found starting from page 175.

P1.1 ■ 42 J	P1.2 ■ 47 J	P1.3 ■ 49 J	P2.1 ■ 36 J	P2.2 ■ 32 I	P2.3 ■ 28 E	P3.1 ■ 34 I	P3.2 ■ 27 I	P3.3 ■ 23 E	P4.1 ■ 20 I	P4.2 ■ 17 E	P4.3 ■ 14 E	M1.1 ■ 21 F	M1.2 ■ 17 F
M2.1 ■ 18 F	M2.2 ■ 15 F	M3.1 ■ 8 F	M3.2 ■ 7 F	M3.3 ■ 6 F	M4.1 ■ 9 D	K1.1 ■ 34 L	K1.2 ■ 25 L	K1.3 ■ 19 L	K2.1 ■ 32 L	K2.2 ■ 26 L	K2.3 ■ 21 J	K3.1 ■ 28 L	K3.2 ■ 22 L
K3.3 ■ 17 J	K4.1 ■ 26 L	K4.2 ■ 20 L	K4.3 ■ 14 J	K4.4 ■ 12 J	K4.5 ■ 10 J	K5.1 ■ 30 L	K5.2 ■ 22 L	K5.3 ■ 17 J	N1.1 ■ 75 L	N1.2 ■ 56 L	N1.3 ■ 38 N	N2.1 ■ 62 N	N2.2 ■ 55 N
N2.3 ■ 40 N	N3.1 ■ 112 J	N3.2 ■ 66 J	N3.3 ■ 33 H	N4.1 ■ 55 J	N4.2 ■ 40 H	S1.1 ■ 30 G	S1.2 ■ 18 G	S1.3 ■ 10 C	S2.1 ■ 12 G	S2.2 ■ 8 E	S3.1 ■ 9 G	S3.2 ■ 6 E	S4.1 ■ 7 G
S4.2 ■ 5 E													

Product	DC [inch]	DC [mm]	DC [inch]	LCF [mm]	OAL [mm]	DCON MS [mm]
A9201.0	–	1.00	0.0394	6.0	26.0	1.00
A9201.1	–	1.10	0.0433	7.0	28.0	1.10
A9203/64	3/64	1.19	0.0469	13.0	35.0	1.19
A9201.2	–	1.20	0.0472	8.0	30.0	1.20
A9201.25	–	1.25	0.0492	8.0	30.0	1.25
A9201.3	–	1.30	0.0512	8.0	30.0	1.30
A9201.35	–	1.35	0.0531	9.0	32.0	1.35
A9201.4	–	1.40	0.0551	9.0	32.0	1.40
A9201.5	–	1.50	0.0591	9.0	32.0	1.50
A9201.55	–	1.55	0.0610	10.0	34.0	1.55
A9201/16	1/16	1.59	0.0625	16.0	41.0	1.59
A9201.6	–	1.60	0.0630	10.0	34.0	1.60
A9201.7	–	1.70	0.0669	10.0	34.0	1.70
A9201.75	–	1.75	0.0689	11.0	36.0	1.75
A9201.8	–	1.80	0.0709	11.0	36.0	1.80
A9201.9	–	1.90	0.0748	11.0	36.0	1.90
A9205/64	5/64	1.98	0.0781	17.0	43.0	1.98
A9202.0	–	2.00	0.0787	12.0	38.0	2.00
A9202.1	–	2.10	0.0827	12.0	38.0	2.10
A9202.15	–	2.15	0.0846	13.0	40.0	2.15
A9202.2	–	2.20	0.0866	13.0	40.0	2.20
A9202.3	–	2.30	0.0906	13.0	40.0	2.30
A9202.35	–	2.35	0.0925	14.0	43.0	2.35
A9203/32	3/32	2.38	0.0938	19.0	41.0	2.38

Product	DC [inch]	DC [mm]	DC [inch]	LCF [mm]	OAL [mm]	DCON MS [mm]
A9202.4	–	2.40	0.0945	14.0	43.0	2.40
A9202.5	–	2.50	0.0984	14.0	43.0	2.50
A9202.6	–	2.60	0.1024	14.0	43.0	2.60
A9202.7	–	2.70	0.1063	16.0	46.0	2.70
A9207/64	7/64	2.78	0.1094	21.0	46.0	2.78
A9202.8	–	2.80	0.1102	16.0	46.0	2.80
A9202.9	–	2.90	0.1142	16.0	46.0	2.90
A9203.0	–	3.00	0.1181	16.0	46.0	3.00
A9203.1	–	3.10	0.1220	18.0	49.0	3.10
A9201/8	1/8	3.18	0.1250	22.0	48.0	3.18
A9203.2	–	3.20	0.1260	18.0	49.0	3.20
A9203.3	–	3.30	0.1299	18.0	49.0	3.30
A9203.4	–	3.40	0.1339	20.0	52.0	3.40
A9203.5	–	3.50	0.1378	20.0	52.0	3.50
A9209/64	9/64	3.57	0.1406	24.0	49.0	3.57
A9203.6	–	3.60	0.1417	20.0	52.0	3.60
A9203.7	–	3.70	0.1457	20.0	52.0	3.70
A9203.8	–	3.80	0.1496	22.0	55.0	3.80
A9203.9	–	3.90	0.1535	22.0	55.0	3.90
A9205/32	5/32	3.97	0.1563	25.0	52.0	3.97
A9204.0	–	4.00	0.1575	22.0	55.0	4.00
A9204.1	–	4.10	0.1614	22.0	55.0	4.10
A9204.2	–	4.20	0.1654	22.0	55.0	4.20
A9204.3	–	4.30	0.1693	24.0	58.0	4.30



Product	DC	DC	DC	LCF	OAL	D CON MS
	[inch]	[mm]	[inch]	[mm]	[mm]	[mm]
A92011/64	11/64	4.37	0.1719	27.0	54.0	4.37
A9204.4	–	4.40	0.1732	24.0	58.0	4.40
A9204.5	–	4.50	0.1772	24.0	58.0	4.50
A9204.6	–	4.60	0.1811	24.0	58.0	4.60
A9204.7	–	4.70	0.1850	24.0	58.0	4.70
A9203/16	3/16	4.76	0.1875	29.0	56.0	4.76
A9204.8	–	4.80	0.1890	26.0	62.0	4.80
A9204.9	–	4.90	0.1929	26.0	62.0	4.90
A9205.0	–	5.00	0.1969	26.0	62.0	5.00
A9205.1	–	5.10	0.2008	26.0	62.0	5.10
A92013/64	13/64	5.16	0.2031	30.0	57.0	5.16
A9205.2	–	5.20	0.2047	26.0	62.0	5.20
A9205.3	–	5.30	0.2087	26.0	62.0	5.30
A9205.4	–	5.40	0.2126	28.0	66.0	5.40
A9205.5	–	5.50	0.2165	28.0	66.0	5.50
A9207/32	7/32	5.56	0.2188	32.0	60.0	5.56
A9205.6	–	5.60	0.2205	28.0	66.0	5.60
A9205.7	–	5.70	0.2244	28.0	66.0	5.70
A9205.8	–	5.80	0.2283	28.0	66.0	5.80
A9205.9	–	5.90	0.2323	28.0	66.0	5.90
A92015/64	15/64	5.95	0.2344	33.0	62.0	5.95
A9206.0	–	6.00	0.2362	28.0	66.0	6.00
A9206.1	–	6.10	0.2402	31.0	70.0	6.10
A9206.2	–	6.20	0.2441	31.0	70.0	6.20
A9206.3	–	6.30	0.2480	31.0	70.0	6.30
A9201/4	1/4	6.35	0.2500	35.0	64.0	6.35
A9206.4	–	6.40	0.2520	31.0	70.0	6.40
A9206.5	–	6.50	0.2559	31.0	70.0	6.50
A9206.6	–	6.60	0.2598	31.0	70.0	6.60
A9206.7	–	6.70	0.2638	31.0	70.0	6.70
A92017/64	17/64	6.75	0.2656	37.0	67.0	6.75
A9206.8	–	6.80	0.2677	34.0	74.0	6.80
A9206.9	–	6.90	0.2717	34.0	74.0	6.90
A9207.0	–	7.00	0.2756	34.0	74.0	7.00
A9207.1	–	7.10	0.2795	34.0	74.0	7.10
A9209/32	9/32	7.14	0.2813	38.0	68.0	7.14
A9207.2	–	7.20	0.2835	34.0	74.0	7.20
A9207.3	–	7.30	0.2874	34.0	74.0	7.30
A9207.4	–	7.40	0.2913	34.0	74.0	7.40
A9207.5	–	7.50	0.2953	34.0	74.0	7.50
A92019/64	19/64	7.54	0.2969	40.0	70.0	7.54
A9207.6	–	7.60	0.2992	37.0	79.0	7.60
A9207.7	–	7.70	0.3031	37.0	79.0	7.70
A9207.8	–	7.80	0.3071	37.0	79.0	7.80
A9207.9	–	7.90	0.3110	37.0	79.0	7.90
A9205/16	5/16	7.94	0.3125	41.0	71.0	7.94
A9208.0	–	8.00	0.3150	37.0	79.0	8.00
A9208.1	–	8.10	0.3189	37.0	79.0	8.10
A9208.2	–	8.20	0.3228	37.0	79.0	8.20
A9208.3	–	8.30	0.3268	37.0	79.0	8.30
A92021/64	21/64	8.33	0.3281	43.0	75.0	8.33
A9208.4	–	8.40	0.3307	37.0	79.0	8.40
A9208.5	–	8.50	0.3346	37.0	79.0	8.50
A9208.6	–	8.60	0.3386	40.0	84.0	8.60
A9208.7	–	8.70	0.3425	40.0	84.0	8.70
A92011/32	11/32	8.73	0.3438	43.0	76.0	8.73
A9208.8	–	8.80	0.3465	40.0	84.0	8.80
A9208.9	–	8.90	0.3504	40.0	84.0	8.90
A9209.0	–	9.00	0.3543	40.0	84.0	9.00
A9209.1	–	9.10	0.3583	40.0	84.0	9.10
A92023/64	23/64	9.13	0.3594	44.0	78.0	9.13
A9209.2	–	9.20	0.3622	40.0	84.0	9.20

Product	DC	DC	DC	LCF	OAL	D CON MS
	[inch]	[mm]	[inch]	[mm]	[mm]	[mm]
A9209.3	–	9.30	0.3661	40.0	84.0	9.30
A9209.4	–	9.40	0.3701	40.0	84.0	9.40
A9209.5	–	9.50	0.3740	40.0	84.0	9.50
A9203/8	3/8	9.52	0.3750	46.0	79.0	9.52
A9209.6	–	9.60	0.3780	43.0	89.0	9.60
A9209.7	–	9.70	0.3819	43.0	89.0	9.70
A9209.8	–	9.80	0.3858	43.0	89.0	9.80
A9209.9	–	9.90	0.3898	43.0	89.0	9.90
A92025/64	25/64	9.92	0.3906	48.0	83.0	9.92
A92010.0	–	10.00	0.3937	43.0	89.0	10.00
A92010.2	–	10.20	0.4016	43.0	89.0	10.20
A92010.3	–	10.30	0.4055	43.0	89.0	10.30
A92013/32	13/32	10.32	0.4063	49.0	84.0	10.32
A92010.5	–	10.50	0.4134	43.0	89.0	10.50
A92027/64	27/64	10.72	0.4219	51.0	86.0	10.72
A92010.8	–	10.80	0.4252	47.0	95.0	10.80
A92011.0	–	11.00	0.4331	47.0	95.0	11.00
A9207/16	7/16	11.11	0.4375	52.0	87.0	11.11
A92011.5	–	11.50	0.4528	47.0	95.0	11.50
A92029/64	29/64	11.51	0.4531	54.0	90.0	11.51
A92011.8	–	11.80	0.4646	47.0	95.0	11.80
A92015/32	15/32	11.91	0.4688	54.0	92.0	11.91
A92012.0	–	12.00	0.4724	51.0	102.0	12.00
A92012.2	–	12.20	0.4803	51.0	102.0	12.20
A92031/64	31/64	12.30	0.4844	56.0	94.0	12.30
A92012.5	–	12.50	0.4921	51.0	102.0	12.50
A9201/2	1/2	12.70	0.5000	57.0	95.0	12.70
A92013.0	–	13.00	0.5118	51.0	102.0	13.00
A92033/64	33/64	13.10	0.5156	60.0	98.0	13.10
A92013.5	–	13.50	0.5315	54.0	107.0	13.50
A92035/64	35/64	13.89	0.5469	64.0	102.0	13.89
A92014.0	–	14.00	0.5512	54.0	107.0	14.00
A9209/16	9/16	14.29	0.5625	64.0	102.0	14.29
A92014.5	–	14.50	0.5709	56.0	111.0	14.50
A92037/64	37/64	14.68	0.5781	67.0	105.0	14.68
A92014.75	–	14.75	0.5807	56.0	111.0	14.75
A92015.0	–	15.00	0.5906	56.0	111.0	15.00
A92019/32	19/32	15.08	0.5938	67.0	105.0	15.08
A92039/64	39/64	15.48	0.6094	70.0	108.0	15.48
A92015.5	–	15.50	0.6102	58.0	115.0	15.50
A9205/8	5/8	15.88	0.6250	70.0	108.0	15.88
A92016.0	–	16.00	0.6299	58.0	115.0	16.00
A92041/64	41/64	16.27	0.6406	73.0	114.0	16.27
A92016.5	–	16.50	0.6496	60.0	119.0	16.50
A92021/32	21/32	16.67	0.6563	73.0	114.0	16.67
A92016.75	–	16.75	0.6594	60.0	119.0	16.75
A92017.0	–	17.00	0.6693	60.0	119.0	17.00
A92043/64	43/64	17.07	0.6719	73.0	117.0	17.07
A92011/16	11/16	17.46	0.6875	73.0	117.0	17.46
A92017.5	–	17.50	0.6890	62.0	123.0	17.50
A92045/64	45/64	17.86	0.7031	76.0	121.0	17.86
A92018.0	–	18.00	0.7087	62.0	123.0	18.00
A92023/32	23/32	18.26	0.7188	76.0	121.0	18.26
A92018.5	–	18.50	0.7283	64.0	127.0	18.50
A92047/64	47/64	18.65	0.7344	79.0	127.0	18.65
A92019.0	–	19.00	0.7480	64.0	127.0	19.00
A9203/4	3/4	19.05	0.7500	79.0	127.0	19.05
A92049/64	49/64	19.45	0.7656	83.0	130.0	19.45
A92019.5	–	19.50	0.7677	66.0	131.0	19.50
A92025/32	25/32	19.84	0.7813	83.0	130.0	19.84
A92020.0	–	20.00	0.7874	66.0	131.0	20.00



A921



PFX HSS-E (5% Cobalt) Stub Drill, Alcrona Top Coated

High performance drill, able to produce high quality and accurate holes at high speeds and feeds (H10 hole tolerance). Self-centering 130° point angle and special parabolic flute design. Suitable for many materials. Alcrona-TOP coating improves performance and extends the tool life.



PFX

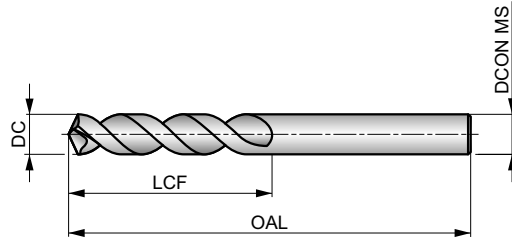

HSS-E	DIN ANSI	3×D
130°	Alcrona Top	
λ>35°	R	DC h8

Workpiece material group suitability, starting values for cutting speed (m/min) and feed Alpha Code. Tables with feed per revolution can be found starting from page 175.

P1.1 ■ 70 M	P1.2 ■ 79 M	P1.3 ■ 81 M	P2.1 ■ 60 M	P2.2 ■ 53 J	P2.3 ■ 47 G	P3.1 ■ 56 J	P3.2 ■ 45 J	P3.3 ■ 38 G	P4.1 ■ 33 J	P4.2 ■ 28 G	P4.3 ■ 23 G	M1.1 ■ 23 F	M1.2 ■ 20 F
M2.1 ■ 21 F	M2.2 ■ 17 F	M3.1 ■ 10 F	M3.2 ■ 9 F	M3.3 ■ 8 F	M4.1 ■ 11 D	K1.1 ■ 53 L	K1.2 ■ 39 L	K1.3 ■ 29 L	K2.1 ■ 52 L	K2.2 ■ 42 L	K2.3 ■ 33 J	K3.1 ■ 46 L	K3.2 ■ 35 L
K3.3 ■ 28 J	K4.1 ■ 42 L	K4.2 ■ 32 L	K4.3 ■ 23 J	K4.4 ■ 20 J	K4.5 ■ 17 J	K5.1 ■ 48 L	K5.2 ■ 36 L	K5.3 ■ 28 J	S1.1 ■ 48 I	S1.2 ■ 29 I	S1.3 ■ 16 E	S2.1 ■ 19 I	S2.2 ■ 14 G
S3.1 ■ 14 I	S3.2 ■ 10 G	S4.1 ■ 11 I	S4.2 ■ 8 G										

Product	DC	DC	DC	LCF	OAL	DCON MS
	[inch]	[mm]	[inch]	[mm]	[mm]	[mm]
A9212.5	–	2.50	0.0984	14.0	43.0	2.50
A9212.6	–	2.60	0.1024	14.0	43.0	2.60
A9212.7	–	2.70	0.1063	16.0	46.0	2.70
A9217/64	7/64	2.78	0.1094	21.0	46.0	2.78
A9212.9	–	2.90	0.1142	16.0	46.0	2.90
A9213.0	–	3.00	0.1181	16.0	46.0	3.00
A9213.1	–	3.10	0.1220	18.0	49.0	3.10
A9211/8	1/8	3.18	0.1250	22.0	48.0	3.18
A9213.2	–	3.20	0.1260	18.0	49.0	3.20
A9213.3	–	3.30	0.1299	18.0	49.0	3.30
A9213.4	–	3.40	0.1339	20.0	52.0	3.40
A9213.5	–	3.50	0.1378	20.0	52.0	3.50
A9219/64	9/64	3.57	0.1406	24.0	49.0	3.57
A9213.6	–	3.60	0.1417	20.0	52.0	3.60
A9213.7	–	3.70	0.1457	20.0	52.0	3.70
A9213.8	–	3.80	0.1496	22.0	55.0	3.80
A9213.9	–	3.90	0.1535	22.0	55.0	3.90
A9215/32	5/32	3.97	0.1563	25.0	52.0	3.97
A9214.0	–	4.00	0.1575	22.0	55.0	4.00
A9214.1	–	4.10	0.1614	22.0	55.0	4.10
A9214.2	–	4.20	0.1654	22.0	55.0	4.20
A9214.3	–	4.30	0.1693	24.0	58.0	4.30
A92111/64	11/64	4.37	0.1719	27.0	54.0	4.37
A9214.4	–	4.40	0.1732	24.0	58.0	4.40
A9214.5	–	4.50	0.1772	24.0	58.0	4.50
A9214.6	–	4.60	0.1811	24.0	58.0	4.60

Product	DC	DC	DC	LCF	OAL	DCON MS
	[inch]	[mm]	[inch]	[mm]	[mm]	[mm]
A9214.7	–	4.70	0.1850	24.0	58.0	4.70
A9213/16	3/16	4.76	0.1875	29.0	56.0	4.76
A9214.8	–	4.80	0.1890	26.0	62.0	4.80
A9214.9	–	4.90	0.1929	26.0	62.0	4.90
A9215.0	–	5.00	0.1969	26.0	62.0	5.00
A9215.1	–	5.10	0.2008	26.0	62.0	5.10
A92113/64	13/64	5.16	0.2031	30.0	57.0	5.16
A9215.2	–	5.20	0.2047	26.0	62.0	5.20
A9215.3	–	5.30	0.2087	26.0	62.0	5.30
A9215.4	–	5.40	0.2126	28.0	66.0	5.40
A9215.5	–	5.50	0.2165	28.0	66.0	5.50
A9217/32	7/32	5.56	0.2188	32.0	60.0	5.56
A9215.6	–	5.60	0.2205	28.0	66.0	5.60
A9215.7	–	5.70	0.2244	28.0	66.0	5.70
A9215.8	–	5.80	0.2283	28.0	66.0	5.80
A9215.9	–	5.90	0.2323	28.0	66.0	5.90
A92115/64	15/64	5.95	0.2344	33.0	62.0	5.95
A9216.0	–	6.00	0.2362	28.0	66.0	6.00
A9216.1	–	6.10	0.2402	31.0	70.0	6.10
A9216.2	–	6.20	0.2441	31.0	70.0	6.20
A9216.3	–	6.30	0.2480	31.0	70.0	6.30
A9211/4	1/4	6.35	0.2500	35.0	64.0	6.35
A9216.4	–	6.40	0.2520	31.0	70.0	6.40
A9216.5	–	6.50	0.2559	31.0	70.0	6.50
A9216.6	–	6.60	0.2598	31.0	70.0	6.60
A9216.7	–	6.70	0.2638	31.0	70.0	6.70



Product	DC	DC	DC	LCF	OAL	DCON MS
	[inch]	[mm]	[inch]	[mm]	[mm]	[mm]
A92117/64	17/64	6.75	0.2656	37.0	67.0	6.75
A9216.8	–	6.80	0.2677	34.0	74.0	6.80
A9216.9	–	6.90	0.2717	34.0	74.0	6.90
A9217.0	–	7.00	0.2756	34.0	74.0	7.00
A9217.1	–	7.10	0.2795	34.0	74.0	7.10
A9219/32	9/32	7.14	0.2813	38.0	68.0	7.14
A9217.2	–	7.20	0.2835	34.0	74.0	7.20
A9217.3	–	7.30	0.2874	34.0	74.0	7.30
A9217.4	–	7.40	0.2913	34.0	74.0	7.40
A9217.5	–	7.50	0.2953	34.0	74.0	7.50
A92119/64	19/64	7.54	0.2969	40.0	70.0	7.54
A9217.6	–	7.60	0.2992	37.0	79.0	7.60
A9217.7	–	7.70	0.3031	37.0	79.0	7.70
A9217.8	–	7.80	0.3071	37.0	79.0	7.80
A9217.9	–	7.90	0.3110	37.0	79.0	7.90
A9215/16	5/16	7.94	0.3125	41.0	71.0	7.94
A9218.0	–	8.00	0.3150	37.0	79.0	8.00
A9218.1	–	8.10	0.3189	37.0	79.0	8.10
A9218.2	–	8.20	0.3228	37.0	79.0	8.20
A9218.3	–	8.30	0.3268	37.0	79.0	8.30
A92121/64	21/64	8.33	0.3281	43.0	75.0	8.33
A9218.4	–	8.40	0.3307	37.0	79.0	8.40
A9218.5	–	8.50	0.3346	37.0	79.0	8.50
A9218.6	–	8.60	0.3386	40.0	84.0	8.60
A9218.7	–	8.70	0.3425	40.0	84.0	8.70
A92111/32	11/32	8.73	0.3438	43.0	76.0	8.73
A9218.8	–	8.80	0.3465	40.0	84.0	8.80
A9218.9	–	8.90	0.3504	40.0	84.0	8.90
A9219.0	–	9.00	0.3543	40.0	84.0	9.00
A9219.1	–	9.10	0.3583	40.0	84.0	9.10
A92123/64	23/64	9.13	0.3594	44.0	78.0	9.13
A9219.2	–	9.20	0.3622	40.0	84.0	9.20
A9219.3	–	9.30	0.3661	40.0	84.0	9.30
A9219.4	–	9.40	0.3701	40.0	84.0	9.40
A9219.5	–	9.50	0.3740	40.0	84.0	9.50
A9213/8	3/8	9.52	0.3750	46.0	79.0	9.52
A9219.6	–	9.60	0.3780	43.0	89.0	9.60

Product	DC	DC	DC	LCF	OAL	DCON MS
	[inch]	[mm]	[inch]	[mm]	[mm]	[mm]
A9219.7	–	9.70	0.3819	43.0	89.0	9.70
A9219.8	–	9.80	0.3858	43.0	89.0	9.80
A9219.9	–	9.90	0.3898	43.0	89.0	9.90
A92125/64	25/64	9.92	0.3906	48.0	83.0	9.92
A92110.0	–	10.00	0.3937	43.0	89.0	10.00
A92110.2	–	10.20	0.4016	43.0	89.0	10.20
A92110.3	–	10.30	0.4055	43.0	89.0	10.30
A92113/32	13/32	10.32	0.4063	49.0	84.0	10.32
A92110.5	–	10.50	0.4134	43.0	89.0	10.50
A92127/64	27/64	10.72	0.4219	51.0	86.0	10.72
A92110.8	–	10.80	0.4252	47.0	95.0	10.80
A92111.0	–	11.00	0.4331	47.0	95.0	11.00
A9217/16	7/16	11.11	0.4375	52.0	87.0	11.11
A92111.5	–	11.50	0.4528	47.0	95.0	11.50
A92129/64	29/64	11.51	0.4531	54.0	90.0	11.51
A92111.8	–	11.80	0.4646	47.0	95.0	11.80
A92115/32	15/32	11.91	0.4688	54.0	92.0	11.91
A92112.0	–	12.00	0.4724	51.0	102.0	12.00
A92131/64	31/64	12.30	0.4844	56.0	94.0	12.30
A92112.5	–	12.50	0.4921	51.0	102.0	12.50
A9211/2	1/2	12.70	0.5000	57.0	95.0	12.70
A92113.0	–	13.00	0.5118	51.0	102.0	13.00
A92133/64	33/64	13.10	0.5156	60.0	98.0	13.10
A92113.5	–	13.50	0.5315	54.0	107.0	13.50
A92135/64	35/64	13.89	0.5469	64.0	102.0	13.89
A92114.0	–	14.00	0.5512	54.0	107.0	14.00
A9219/16	9/16	14.29	0.5625	64.0	102.0	14.29
A92114.5	–	14.50	0.5709	56.0	111.0	14.50
A92137/64	37/64	14.68	0.5781	67.0	105.0	14.68
A92114.75	–	14.75	0.5807	56.0	111.0	14.75
A92115.0	–	15.00	0.5906	56.0	111.0	15.00
A92119/32	19/32	15.08	0.5938	67.0	105.0	15.08
A92139/64	39/64	15.48	0.6094	70.0	108.0	15.48
A92115.5	–	15.50	0.6102	58.0	115.0	15.50
A9215/8	5/8	15.88	0.6250	70.0	108.0	15.88
A92116.0	–	16.00	0.6299	58.0	115.0	16.00



A002



HSS Jobber Drill, TiN-Tip Coated

Versatile drill for both hand-held and machine drilling. A specially designed 118° split point which helps to self-center the drill when drilling by hand and provides more accurate sized holes. Suitable for many materials. TiN-Tip coating improves performance and extends tool life.

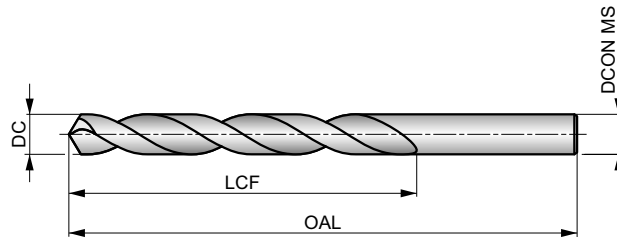

HSS	DIN 338	4xD
118°	TiN-Tip	
λ 20-35°	R	DC h8

Workpiece material group suitability, starting values for cutting speed (m/min) and feed Alpha Code. Tables with feed per revolution can be found starting from page 175.

P1.1 ■ 46 J	P1.2 ■ 52 J	P1.3 ■ 54 J	P2.1 ■ 40 J	P2.2 ■ 35 F	P2.3 ■ 31 F	P3.1 ■ 27 F	P3.2 ■ 21 F	P3.3 ■ 18 F	P4.1 ■ 16 F	P4.2 ■ 13 F	P4.3 ■ 11 E	M1.1 ■ 27 F	M1.2 ■ 23 F
M2.1 ■ 24 F	M2.2 ■ 20 F	M3.1 ■ 14 G	M3.2 ■ 12 G	M3.3 ■ 11 G	M4.1 ■ 16 C	K1.1 ■ 40 J	K1.2 ■ 30 E	K1.3 ■ 22 E	K2.1 ■ 34 E	K2.2 ■ 28 E	K2.3 ■ 22 E	K3.1 ■ 30 E	K3.2 ■ 23 E
K3.3 ■ 19 E	K4.1 ■ 28 E	K4.2 ■ 21 E	K4.3 ■ 16 E	K4.4 ■ 13 E	K4.5 ■ 11 E	K5.1 ■ 32 E	K5.2 ■ 24 E	K5.3 ■ 19 E	N1.1 ■ 41 K	N1.2 ■ 31 K	N1.3 ■ 21 J	N2.1 ■ 51 I	N2.2 ■ 46 I
N2.3 ■ 33 I	N3.1 ■ 56 H	N3.2 ■ 33 I	N3.3 ■ 17 G	N4.1 ■ 30 I	N4.2 ■ 50 H	N4.3 ■ 35 F	S1.1 ■ 23 F	S1.2 ■ 13 D	S1.3 ■ 7 B	S2.1 ■ 9 E	S2.2 ■ 4 A	S3.1 ■ 7 E	S3.2 ■ 3 A
S4.1 ■ 5 E	S4.2 ■ 2 A												

DC < 2mm Bright; DC >= 2mm TiN Tipped and Split Point.

Products from this series are also available in set. Please see A087, A089 A094, A095 or A099.

Product	DC [inch]	DC [mm]	DC [inch]	LCF [mm]	OAL [mm]	DCON MS [mm]
A0021.0	—	1.00	0.0394	12.0	34.0	1.00
A0021.1	—	1.10	0.0433	14.0	36.0	1.10
A0023/64	3/64	1.19	0.0469	16.0	38.0	1.19
A0021.2	—	1.20	0.0472	16.0	38.0	1.20
A0021.3	—	1.30	0.0512	16.0	38.0	1.30
A0021.4	—	1.40	0.0551	18.0	40.0	1.40
A0021.5	—	1.50	0.0591	18.0	40.0	1.50
A0021/16	1/16	1.59	0.0625	20.0	43.0	1.59
A0021.6	—	1.60	0.0630	20.0	43.0	1.60
A0021.7	—	1.70	0.0669	20.0	43.0	1.70
A0021.8	—	1.80	0.0709	22.0	46.0	1.80
A0021.9	—	1.90	0.0748	22.0	46.0	1.90
A0025/64	5/64	1.98	0.0781	24.0	49.0	1.98
A0022.0	—	2.00	0.0787	24.0	49.0	2.00
A0022.1	—	2.10	0.0827	24.0	49.0	2.10
A0022.2	—	2.20	0.0866	27.0	53.0	2.20
A0022.3	—	2.30	0.0906	27.0	53.0	2.30
A0023/32	3/32	2.38	0.0938	30.0	57.0	2.38
A0022.4	—	2.40	0.0945	30.0	57.0	2.40
A0022.5	—	2.50	0.0984	30.0	57.0	2.50
A0022.6	—	2.60	0.1024	30.0	57.0	2.60
A0022.7	—	2.70	0.1063	33.0	61.0	2.70
A0027/64	7/64	2.78	0.1094	33.0	61.0	2.78
A0022.8	—	2.80	0.1102	33.0	61.0	2.80

Product	DC [inch]	DC [mm]	DC [inch]	LCF [mm]	OAL [mm]	DCON MS [mm]
A0022.9	—	2.90	0.1142	33.0	61.0	2.90
A0023.0	—	3.00	0.1181	33.0	61.0	3.00
A0023.1	—	3.10	0.1220	36.0	65.0	3.10
A0021/8	1/8	3.18	0.1250	36.0	65.0	3.18
A0023.2	—	3.20	0.1260	36.0	65.0	3.20
A0023.25	—	3.25	0.1280	36.0	65.0	3.25
A0023.3	—	3.30	0.1299	36.0	65.0	3.30
A0023.4	—	3.40	0.1339	39.0	70.0	3.40
A0023.5	—	3.50	0.1378	39.0	70.0	3.50
A0029/64	9/64	3.57	0.1406	39.0	70.0	3.57
A0023.6	—	3.60	0.1417	39.0	70.0	3.60
A0023.7	—	3.70	0.1457	39.0	70.0	3.70
A0023.8	—	3.80	0.1496	43.0	75.0	3.80
A0023.9	—	3.90	0.1535	43.0	75.0	3.90
A0025/32	5/32	3.97	0.1563	43.0	75.0	3.97
A0024.0	—	4.00	0.1575	43.0	75.0	4.00
A0024.1	—	4.10	0.1614	43.0	75.0	4.10
A0024.2	—	4.20	0.1654	43.0	75.0	4.20
A0024.3	—	4.30	0.1693	47.0	80.0	4.30
A00211/64	11/64	4.37	0.1719	47.0	80.0	4.37
A0024.4	—	4.40	0.1732	47.0	80.0	4.40
A0024.5	—	4.50	0.1772	47.0	80.0	4.50
A0024.6	—	4.60	0.1811	47.0	80.0	4.60
A0024.7	—	4.70	0.1850	47.0	80.0	4.70



Product	DC	DC	DC	LCF	OAL	D CON MS
	[inch]	[mm]	[inch]	[mm]	[mm]	[mm]
A0023/16	3/16	4.76	0.1875	52.0	86.0	4.76
A0024.8	–	4.80	0.1890	52.0	86.0	4.80
A0024.9	–	4.90	0.1929	52.0	86.0	4.90
A0025.0	–	5.00	0.1969	52.0	86.0	5.00
A0025.1	–	5.10	0.2008	52.0	86.0	5.10
A00213/64	13/64	5.16	0.2031	52.0	86.0	5.16
A0025.2	–	5.20	0.2047	52.0	86.0	5.20
A0025.3	–	5.30	0.2087	52.0	86.0	5.30
A0025.4	–	5.40	0.2126	57.0	93.0	5.40
A0025.5	–	5.50	0.2165	57.0	93.0	5.50
A0027/32	7/32	5.56	0.2188	57.0	93.0	5.56
A0025.6	–	5.60	0.2205	57.0	93.0	5.60
A0025.7	–	5.70	0.2244	57.0	93.0	5.70
A0025.8	–	5.80	0.2283	57.0	93.0	5.80
A0025.9	–	5.90	0.2323	57.0	93.0	5.90
A00215/64	15/64	5.95	0.2344	57.0	93.0	5.95
A0026.0	–	6.00	0.2362	57.0	93.0	6.00
A0026.1	–	6.10	0.2402	63.0	101.0	6.10
A0026.2	–	6.20	0.2441	63.0	101.0	6.20
A0026.3	–	6.30	0.2480	63.0	101.0	6.30
A0021/4	1/4	6.35	0.2500	63.0	101.0	6.35
A0026.4	–	6.40	0.2520	63.0	101.0	6.40
A0026.5	–	6.50	0.2559	63.0	101.0	6.50
A0026.6	–	6.60	0.2598	63.0	101.0	6.60
A0026.7	–	6.70	0.2638	63.0	101.0	6.70
A00217/64	17/64	6.75	0.2656	69.0	109.0	6.75
A0026.8	–	6.80	0.2677	69.0	109.0	6.80
A0026.9	–	6.90	0.2717	69.0	109.0	6.90
A0027.0	–	7.00	0.2756	69.0	109.0	7.00
A0027.1	–	7.10	0.2795	69.0	109.0	7.10
A0029/32	9/32	7.14	0.2813	69.0	109.0	7.14
A0027.2	–	7.20	0.2835	69.0	109.0	7.20
A0027.3	–	7.30	0.2874	69.0	109.0	7.30
A0027.4	–	7.40	0.2913	69.0	109.0	7.40
A0027.5	–	7.50	0.2953	69.0	109.0	7.50
A00219/64	19/64	7.54	0.2969	75.0	117.0	7.54
A0027.6	–	7.60	0.2992	75.0	117.0	7.60
A0027.7	–	7.70	0.3031	75.0	117.0	7.70
A0027.8	–	7.80	0.3071	75.0	117.0	7.80
A0027.9	–	7.90	0.3110	75.0	117.0	7.90
A0025/16	5/16	7.94	0.3125	75.0	117.0	7.94
A0028.0	–	8.00	0.3150	75.0	117.0	8.00
A0028.1	–	8.10	0.3189	75.0	117.0	8.10
A0028.2	–	8.20	0.3228	75.0	117.0	8.20
A0028.3	–	8.30	0.3268	75.0	117.0	8.30
A00221/64	21/64	8.33	0.3281	75.0	117.0	8.33
A0028.4	–	8.40	0.3307	75.0	117.0	8.40
A0028.5	–	8.50	0.3346	75.0	117.0	8.50
A0028.6	–	8.60	0.3386	81.0	125.0	8.60
A0028.7	–	8.70	0.3425	81.0	125.0	8.70
A00211/32	11/32	8.73	0.3438	81.0	125.0	8.73
A0028.8	–	8.80	0.3465	81.0	125.0	8.80
A0028.9	–	8.90	0.3504	81.0	125.0	8.90
A0029.0	–	9.00	0.3543	81.0	125.0	9.00
A0029.1	–	9.10	0.3583	81.0	125.0	9.10
A00223/64	23/64	9.13	0.3594	81.0	125.0	9.13
A0029.2	–	9.20	0.3622	81.0	125.0	9.20
A0029.3	–	9.30	0.3661	81.0	125.0	9.30
A0029.4	–	9.40	0.3701	81.0	125.0	9.40
A0029.5	–	9.50	0.3740	81.0	125.0	9.50
A0023/8	3/8	9.52	0.3750	87.0	133.0	9.52
A0029.6	–	9.60	0.3780	87.0	133.0	9.60
A0029.7	–	9.70	0.3819	87.0	133.0	9.70
A0029.8	–	9.80	0.3858	87.0	133.0	9.80
A0029.9	–	9.90	0.3898	87.0	133.0	9.90
A00225/64	25/64	9.92	0.3906	87.0	133.0	9.92
A00210.0	–	10.00	0.3937	87.0	133.0	10.00

Product	DC	DC	DC	LCF	OAL	D CON MS
	[inch]	[mm]	[inch]	[mm]	[mm]	[mm]
A00210.1	–	10.10	0.3976	87.0	133.0	10.10
A00210.2	–	10.20	0.4016	87.0	133.0	10.20
A00210.3	–	10.30	0.4055	87.0	133.0	10.30
A00213/32	13/32	10.32	0.4063	87.0	133.0	10.32
A00210.4	–	10.40	0.4094	87.0	133.0	10.40
A00210.5	–	10.50	0.4134	87.0	133.0	10.50
A00210.6	–	10.60	0.4173	87.0	133.0	10.60
A00210.7	–	10.70	0.4213	94.0	142.0	10.70
A00227/64	27/64	10.72	0.4219	94.0	142.0	10.72
A00210.8	–	10.80	0.4252	94.0	142.0	10.80
A00210.9	–	10.90	0.4291	94.0	142.0	10.90
A00211.0	–	11.00	0.4331	94.0	142.0	11.00
A00211.1	–	11.10	0.4370	94.0	142.0	11.10
A0027/16	7/16	11.11	0.4375	94.0	142.0	11.11
A00211.2	–	11.20	0.4409	94.0	142.0	11.20
A00211.3	–	11.30	0.4449	94.0	142.0	11.30
A00211.4	–	11.40	0.4488	94.0	142.0	11.40
A00211.5	–	11.50	0.4528	94.0	142.0	11.50
A00229/64	29/64	11.51	0.4531	94.0	142.0	11.51
A00211.6	–	11.60	0.4567	94.0	142.0	11.60
A00211.7	–	11.70	0.4606	94.0	142.0	11.70
A00211.8	–	11.80	0.4646	94.0	142.0	11.80
A00211.9	–	11.90	0.4685	101.0	151.0	11.90
A00215/32	15/32	11.91	0.4688	101.0	151.0	11.91
A00212.0	–	12.00	0.4724	101.0	151.0	12.00
A00212.1	–	12.10	0.4764	101.0	151.0	12.10
A00212.2	–	12.20	0.4803	101.0	151.0	12.20
A00212.3	–	12.30	0.4843	101.0	151.0	12.30
A00231/64	31/64	12.30	0.4844	101.0	151.0	12.30
A00212.4	–	12.40	0.4882	101.0	151.0	12.40
A00212.5	–	12.50	0.4921	101.0	151.0	12.50
A00212.6	–	12.60	0.4961	101.0	151.0	12.60
A00212.7	–	12.70	0.5000	101.0	151.0	12.70
A0021/2	1/2	12.70	0.5000	101.0	151.0	12.70
A00212.8	–	12.80	0.5039	101.0	151.0	12.80
A00212.9	–	12.90	0.5079	101.0	151.0	12.90
A00213.0	–	13.00	0.5118	101.0	151.0	13.00
A00233/64	33/64	13.10	0.5156	101.0	151.0	13.10
A00213.1	–	13.10	0.5157	101.0	151.0	13.10
A00213.2	–	13.20	0.5197	101.0	151.0	13.20
A00213.25	–	13.25	0.5217	108.0	160.0	13.25
A00213.3	–	13.30	0.5236	108.0	160.0	13.30
A00213.4	–	13.40	0.5276	108.0	160.0	13.40
A00217/32	17/32	13.49	0.5313	108.0	160.0	13.49
A00213.5	–	13.50	0.5315	108.0	160.0	13.50
A00213.6	–	13.60	0.5354	108.0	160.0	13.60
A00213.7	–	13.70	0.5394	108.0	160.0	13.70
A00213.75	–	13.75	0.5413	108.0	160.0	13.75
A00213.8	–	13.80	0.5433	108.0	160.0	13.80
A00235/64	35/64	13.89	0.5469	108.0	160.0	13.89
A00213.9	–	13.90	0.5472	108.0	160.0	13.90
A00214.0	–	14.00	0.5512	108.0	160.0	14.00
A00214.25	–	14.25	0.5610	114.0	169.0	14.25
A0029/16	9/16	14.29	0.5625	114.0	169.0	14.29
A00214.5	–	14.50	0.5709	114.0	169.0	14.50
A00237/64	37/64	14.68	0.5781	114.0	169.0	14.68
A00214.75	–	14.75	0.5807	114.0	169.0	14.75
A00215.0	–	15.00	0.5906	114.0	169.0	15.00
A00219/32	19/32	15.08	0.5938	120.0	178.0	15.08
A00215.25	–	15.25	0.6004	120.0	178.0	15.25
A00239/64	39/64	15.48	0.6094	120.0	178.0	15.48
A00215.5	–	15.50	0.6102	120.0	178.0	15.50
A00215.75	–	15.75	0.6201	120.0	178.0	15.75
A0025/8	5/8	15.88	0.6250	120.0	178.0	15.88
A00216.0	–	16.00	0.6299	120.0	178.0	16.00



A002S



HSS Jobber Drill, TiN-Tip Coated

Versatile drill for both hand-held and machine drilling. A specially designed 118° split point which helps to self-center the drill when drilling by hand and provides more accurate sized hole. Suitable for many materials. TiN-Tip coating improves performance and extends tool life.

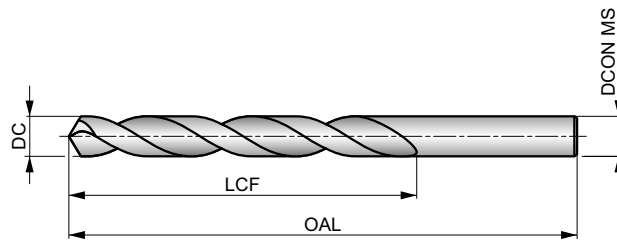

HSS	DIN 338	4xD
118°	TiN-Tip	
λ 20-35°	R	DC h8

Workpiece material group suitability, starting values for cutting speed (m/min) and feed Alpha Code. Tables with feed per revolution can be found starting from page 175.

P1.1 ■ 46 J	P1.2 ■ 52 J	P1.3 ■ 54 J	P2.1 ■ 40 J	P2.2 ■ 35 F	P2.3 ■ 31 F	P3.1 ■ 27 F	P3.2 ■ 21 F	P3.3 ■ 18 F	P4.1 ■ 16 F	P4.2 ■ 13 F	P4.3 ■ 11 E	M1.1 ■ 27 F	M1.2 ■ 23 F
M2.1 ■ 24 F	M2.2 ■ 20 F	M3.1 ■ 14 G	M3.2 ■ 12 G	M3.3 ■ 11 G	M4.1 ■ 16 C	K1.1 ■ 40 J	K1.2 ■ 30 E	K1.3 ■ 22 E	K2.1 ■ 34 E	K2.2 ■ 28 E	K2.3 ■ 22 E	K3.1 ■ 30 E	K3.2 ■ 23 E
K3.3 ■ 19 E	K4.1 ■ 28 E	K4.2 ■ 21 E	K4.3 ■ 16 E	K4.4 ■ 13 E	K4.5 ■ 11 E	K5.1 ■ 32 E	K5.2 ■ 24 E	K5.3 ■ 19 E	N1.1 ■ 41 K	N1.2 ■ 31 K	N1.3 ■ 21 J	N2.1 ■ 51 I	N2.2 ■ 46 I
N2.3 ■ 33 I	N3.1 ■ 56 H	N3.2 ■ 33 I	N3.3 ■ 17 G	N4.1 ■ 30 I	N4.2 ■ 50 H	N4.3 ■ 35 F	S1.1 ■ 23 F	S1.2 ■ 13 D	S1.3 ■ 7 B	S2.1 ■ 9 E	S2.2 ■ 4 A	S3.1 ■ 7 E	S3.2 ■ 3 A
S4.1 ■ 5 E	S4.2 ■ 2 A												

DC <= 5mm Sold in packs of 2.

Product	DC [inch]	DC [mm]	DC [inch]	LCF [mm]	OAL [mm]	DCON MS [mm]
A002S2.0	–	2.00	0.0787	24.0	49.0	2.00
A002S2.5	–	2.50	0.0984	30.0	57.0	2.50
A002S3.0	–	3.00	0.1181	33.0	61.0	3.00
A002S1/8	1/8	3.18	0.1250	36.0	65.0	3.18
A002S3.2	–	3.20	0.1260	36.0	65.0	3.20
A002S3.3	–	3.30	0.1299	36.0	65.0	3.30
A002S3.5	–	3.50	0.1378	39.0	70.0	3.50
A002S5/32	5/32	3.97	0.1563	43.0	75.0	3.97
A002S4.0	–	4.00	0.1575	43.0	75.0	4.00
A002S4.1	–	4.10	0.1614	43.0	75.0	4.10
A002S4.2	–	4.20	0.1654	43.0	75.0	4.20
A002S4.5	–	4.50	0.1772	47.0	80.0	4.50
A002S3/16	3/16	4.76	0.1875	52.0	86.0	4.76
A002S5.0	–	5.00	0.1969	52.0	86.0	5.00
A002S13/64	13/64	5.16	0.2031	52.0	86.0	5.16
A002S5.5	–	5.50	0.2165	57.0	93.0	5.50
A002S7/32	7/32	5.56	0.2188	57.0	93.0	5.56
A002S6.0	–	6.00	0.2362	57.0	93.0	6.00
A002S1/4	1/4	6.35	0.2500	63.0	101.0	6.35
A002S6.5	–	6.50	0.2559	63.0	101.0	6.50

Product	DC [inch]	DC [mm]	DC [inch]	LCF [mm]	OAL [mm]	DCON MS [mm]
A002S17/64	17/64	6.75	0.2656	69.0	109.0	6.75
A002S6.8	–	6.80	0.2677	69.0	109.0	6.80
A002S7.0	–	7.00	0.2756	69.0	109.0	7.00
A002S7.5	–	7.50	0.2953	69.0	109.0	7.50
A002S5/16	5/16	7.94	0.3125	75.0	117.0	7.94
A002S8.0	–	8.00	0.3150	75.0	117.0	8.00
A002S8.2	–	8.20	0.3228	75.0	117.0	8.20
A002S8.5	–	8.50	0.3346	75.0	117.0	8.50
A002S9.0	–	9.00	0.3543	81.0	125.0	9.00
A002S9.5	–	9.50	0.3740	81.0	125.0	9.50
A002S3/8	3/8	9.52	0.3750	87.0	133.0	9.52
A002S10.0	–	10.00	0.3937	87.0	133.0	10.00
A002S10.2	–	10.20	0.4016	87.0	133.0	10.20
A002S10.5	–	10.50	0.4134	87.0	133.0	10.50
A002S11.0	–	11.00	0.4331	94.0	142.0	11.00
A002S11.5	–	11.50	0.4528	94.0	142.0	11.50
A002S12.0	–	12.00	0.4724	101.0	151.0	12.00
A002S12.5	–	12.50	0.4921	101.0	151.0	12.50
A002S1/2	1/2	12.70	0.5000	101.0	151.0	12.70
A002S13.0	–	13.00	0.5118	101.0	151.0	13.00



A100



HSS Jobber Drill, Steam Tempered Finish

A great and versatile all-around drill with a 118° conventional point, which provides strength and is easy to regrind, making it very cost-effective. Usable for hand-held and machine drilling. Steam tempered finish retains cutting fluid and prevents chip tool welding. Suitable for many materials.

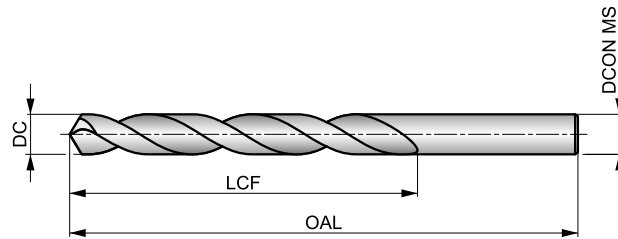

HSS	DIN 338	4×D
118°	ST	
λ20-35°	R	DC h8

Workpiece material group suitability, starting values for cutting speed (m/min) and feed Alpha Code. Tables with feed per revolution can be found starting from page 175.

P1.1 ■ 33 H	P1.2 ■ 37 H	P1.3 ■ 38 H	P2.1 ■ 28 H	P2.2 ■ 25 F	P2.3 ■ 22 E	P3.1 ■ 19 F	P3.2 ■ 15 F	P3.3 ■ 13 E	P4.1 ■ 11 F	P4.2 ■ 10 E	P4.3 ■ 8 D	M1.1 ■ 21 E	M1.2 ■ 17 E
M2.1 ■ 18 E	M2.2 ■ 15 E	M3.1 ■ 9 G	M3.2 ■ 8 G	M3.3 ■ 7 G	M4.1 ■ 9 C	K1.1 ■ 30 H	K1.2 ■ 22 F	K1.3 ■ 17 F	K2.1 ■ 25 E	K2.2 ■ 20 E	K2.3 ■ 16 E	K3.1 ■ 22 E	K3.2 ■ 17 E
K3.3 ■ 13 E	K4.1 ■ 20 E	K4.2 ■ 15 E	K4.3 ■ 11 E	K4.4 ■ 10 E	K4.5 ■ 8 E	K5.1 ■ 23 E	K5.2 ■ 17 E	K5.3 ■ 13 E	N1.1 ■ 33 J	N1.2 ■ 25 J	N1.3 ■ 17 I	N2.1 ■ 42 H	N2.2 ■ 37 H
N2.3 ■ 27 H	N3.1 ■ 59 H	N3.2 ■ 35 I	N3.3 ■ 18 G	N4.1 ■ 30 J	N4.2 ■ 28 H	N4.3 ■ 14 F	S1.1 ■ 23 E	S1.2 ■ 12 D	S1.3 ■ 6 B	S2.1 ■ 8 E	S2.2 ■ 4 A	S3.1 ■ 6 E	S3.2 ■ 3 A
S4.1 ■ 5 E	S4.2 ■ 2 A												

DC ≤ 1mm; 3/64"; N60. Bright.

Products from this series are also available in set. Please see A190, A191 or A199.

Product	DC	DC	DC	LCF	OAL	DCON MS	Product	DC	DC	DC	LCF	OAL	DCON MS
	[inch]	[mm]	[inch]	[mm]	[mm]	[mm]		[inch]	[mm]	[inch]	[mm]	[mm]	[mm]
A100.2	–	0.20	0.0079	2.5	19.0	0.20	A100.6	–	0.60	0.0236	7.0	24.0	0.60
A100.25	–	0.25	0.0098	3.0	19.0	0.25	A100N73	N73	0.61	0.0240	8.0	26.0	0.61
A100.3	–	0.30	0.0118	3.0	19.0	0.30	A100.62	–	0.62	0.0244	8.0	26.0	0.62
A100.32	–	0.32	0.0126	4.0	19.0	0.32	A100N72	N72	0.64	0.0250	8.0	26.0	0.64
A100N80	N80	0.34	0.0135	4.0	19.0	0.34	A100.65	–	0.65	0.0256	8.0	26.0	0.65
A100.35	–	0.35	0.0138	4.0	19.0	0.35	A100N71	N71	0.66	0.0260	8.0	26.0	0.66
A100N79	N79	0.37	0.0145	4.0	19.0	0.37	A100.68	–	0.68	0.0268	9.0	28.0	0.68
A100.38	–	0.38	0.0150	4.0	19.0	0.38	A100.7	–	0.70	0.0276	9.0	28.0	0.70
A1001/64	1/64	0.40	0.0156	5.0	20.0	0.40	A100N70	N70	0.71	0.0280	9.0	28.0	0.71
A100.4	–	0.40	0.0157	5.0	20.0	0.40	A100.72	–	0.72	0.0283	9.0	28.0	0.72
A100N78	N78	0.41	0.0160	5.0	20.0	0.41	A100N69	N69	0.74	0.0292	9.0	28.0	0.74
A100.42	–	0.42	0.0165	5.0	20.0	0.42	A100.75	–	0.75	0.0295	9.0	28.0	0.75
A100.45	–	0.45	0.0177	5.0	20.0	0.45	A100.78	–	0.78	0.0307	10.0	30.0	0.78
A100N77	N77	0.46	0.0180	5.0	20.0	0.46	A1001/32	1/32	0.79	0.0313	10.0	30.0	0.79
A100.48	–	0.48	0.0189	5.0	20.0	0.48	A100N68	N68	0.79	0.0310	10.0	30.0	0.79
A100.5	–	0.50	0.0197	6.0	22.0	0.50	A100.8	–	0.80	0.0315	10.0	30.0	0.80
A100N76	N76	0.51	0.0200	6.0	22.0	0.51	A100N67	N67	0.81	0.0320	10.0	30.0	0.81
A100.52	–	0.52	0.0205	6.0	22.0	0.52	A100.82	–	0.82	0.0323	10.0	30.0	0.82
A100N75	N75	0.53	0.0210	6.0	22.0	0.53	A100N66	N66	0.84	0.0330	10.0	30.0	0.84
A100.55	–	0.55	0.0217	7.0	24.0	0.55	A100.85	–	0.85	0.0335	10.0	30.0	0.85
A100N74	N74	0.57	0.0225	7.0	24.0	0.57	A100.88	–	0.88	0.0346	11.0	32.0	0.88
A100.58	–	0.58	0.0228	7.0	24.0	0.58	A100N65	N65	0.89	0.0350	11.0	32.0	0.89



Product	DC	DC	DC	LCF	OAL	D CON MS
	[inch]	[mm]	[inch]	[mm]	[mm]	[mm]
A100.9	—	0.90	0.0354	11.0	32.0	0.90
A100N64	N64	0.91	0.0360	11.0	32.0	0.91
A100.92	—	0.92	0.0362	11.0	32.0	0.92
A100N63	N63	0.94	0.0370	11.0	32.0	0.94
A100.95	—	0.95	0.0374	11.0	32.0	0.95
A100N62	N62	0.97	0.0380	12.0	34.0	0.97
A100.98	—	0.98	0.0386	12.0	34.0	0.98
A100N61	N61	0.99	0.0390	12.0	34.0	0.99
A1001.0	—	1.00	0.0394	12.0	34.0	1.00
A100N60	N60	1.02	0.0400	12.0	34.0	1.02
A100N59	N59	1.04	0.0410	12.0	34.0	1.04
A1001.05	—	1.05	0.0413	12.0	34.0	1.05
A100N58	N58	1.07	0.0420	14.0	36.0	1.07
A100N57	N57	1.09	0.0430	14.0	36.0	1.09
A1001.1	—	1.10	0.0433	14.0	36.0	1.10
A1001.15	—	1.15	0.0453	14.0	36.0	1.15
A100N56	N56	1.18	0.0465	14.0	36.0	1.18
A1003/64	3/64	1.19	0.0469	16.0	38.0	1.19
A1001.2	—	1.20	0.0472	16.0	38.0	1.20
A1001.25	—	1.25	0.0492	16.0	38.0	1.25
A1001.3	—	1.30	0.0512	16.0	38.0	1.30
A100N55	N55	1.32	0.0520	16.0	38.0	1.32
A1001.35	—	1.35	0.0531	18.0	40.0	1.35
A1001.4	—	1.40	0.0551	18.0	40.0	1.40
A100N54	N54	1.40	0.0550	18.0	40.0	1.40
A1001.45	—	1.45	0.0571	18.0	40.0	1.45
A1001.5	—	1.50	0.0591	18.0	40.0	1.50
A100N53	N53	1.51	0.0595	20.0	43.0	1.51
A1001.55	—	1.55	0.0610	20.0	43.0	1.55
A1001/16	1/16	1.59	0.0625	20.0	43.0	1.59
A1001.6	—	1.60	0.0630	20.0	43.0	1.60
A100N52	N52	1.61	0.0635	20.0	43.0	1.61
A1001.65	—	1.65	0.0650	20.0	43.0	1.65
A1001.7	—	1.70	0.0669	20.0	43.0	1.70
A100N51	N51	1.70	0.0670	22.0	46.0	1.70
A1001.75	—	1.75	0.0689	22.0	46.0	1.75
A100N50	N50	1.78	0.0700	22.0	46.0	1.78
A1001.8	—	1.80	0.0709	22.0	46.0	1.80
A1001.85	—	1.85	0.0728	22.0	46.0	1.85
A100N49	N49	1.85	0.0730	22.0	46.0	1.85
A1001.9	—	1.90	0.0748	22.0	46.0	1.90
A100N48	N48	1.93	0.0760	24.0	49.0	1.93
A1001.95	—	1.95	0.0768	24.0	49.0	1.95
A1005/64	5/64	1.98	0.0781	24.0	49.0	1.98
A100N47	N47	1.99	0.0785	24.0	49.0	1.99
A1002.0	—	2.00	0.0787	24.0	49.0	2.00
A1002.05	—	2.05	0.0807	24.0	49.0	2.05
A100N46	N46	2.06	0.0810	24.0	49.0	2.06
A100N45	N45	2.08	0.0820	24.0	49.0	2.08
A1002.1	—	2.10	0.0827	24.0	49.0	2.10
A1002.15	—	2.15	0.0846	27.0	53.0	2.15
A100N44	N44	2.18	0.0860	27.0	53.0	2.18
A1002.2	—	2.20	0.0866	27.0	53.0	2.20
A1002.25	—	2.25	0.0886	27.0	53.0	2.25
A100N43	N43	2.26	0.0890	27.0	53.0	2.26
A1002.3	—	2.30	0.0906	27.0	53.0	2.30
A1002.35	—	2.35	0.0925	27.0	53.0	2.35
A1003/32	3/32	2.38	0.0938	30.0	57.0	2.38
A100N42	N42	2.38	0.0935	30.0	57.0	2.38
A1002.4	—	2.40	0.0945	30.0	57.0	2.40
A100N41	N41	2.44	0.0960	30.0	57.0	2.44
A1002.45	—	2.45	0.0965	30.0	57.0	2.45

Product	DC	DC	DC	LCF	OAL	D CON MS
	[inch]	[mm]	[inch]	[mm]	[mm]	[mm]
A100N40	N40	2.49	0.0980	30.0	57.0	2.49
A1002.5	—	2.50	0.0984	30.0	57.0	2.50
A100N39	N39	2.53	0.0995	30.0	57.0	2.53
A1002.55	—	2.55	0.1004	30.0	57.0	2.55
A100N38	N38	2.58	0.1015	30.0	57.0	2.58
A1002.6	—	2.60	0.1024	30.0	57.0	2.60
A100N37	N37	2.64	0.1040	30.0	57.0	2.64
A1002.65	—	2.65	0.1043	30.0	57.0	2.65
A1002.7	—	2.70	0.1063	33.0	61.0	2.70
A100N36	N36	2.71	0.1065	33.0	61.0	2.71
A1002.75	—	2.75	0.1083	33.0	61.0	2.75
A1007/64	7/64	2.78	0.1094	33.0	61.0	2.78
A100N35	N35	2.79	0.1100	33.0	61.0	2.79
A1002.8	—	2.80	0.1102	33.0	61.0	2.80
A100N34	N34	2.82	0.1110	33.0	61.0	2.82
A1002.85	—	2.85	0.1122	33.0	61.0	2.85
A100N33	N33	2.87	0.1130	33.0	61.0	2.87
A1002.9	—	2.90	0.1142	33.0	61.0	2.90
A1002.95	—	2.95	0.1161	33.0	61.0	2.95
A100N32	N32	2.95	0.1160	33.0	61.0	2.95
A1003.0	—	3.00	0.1181	33.0	61.0	3.00
A100N31	N31	3.05	0.1200	36.0	65.0	3.05
A1003.1	—	3.10	0.1220	36.0	65.0	3.10
A1003.15	—	3.15	0.1240	36.0	65.0	3.15
A1001/8	1/8	3.18	0.1250	36.0	65.0	3.18
A1003.2	—	3.20	0.1260	36.0	65.0	3.20
A1003.25	—	3.25	0.1280	36.0	65.0	3.25
A100N30	N30	3.26	0.1285	36.0	65.0	3.26
A1003.3	—	3.30	0.1299	36.0	65.0	3.30
A1003.4	—	3.40	0.1339	39.0	70.0	3.40
A100N29	N29	3.45	0.1360	39.0	70.0	3.45
A1003.5	—	3.50	0.1378	39.0	70.0	3.50
A1009/64	9/64	3.57	0.1406	39.0	70.0	3.57
A100N28	N28	3.57	0.1405	39.0	70.0	3.57
A1003.6	—	3.60	0.1417	39.0	70.0	3.60
A100N27	N27	3.66	0.1440	39.0	70.0	3.66
A1003.7	—	3.70	0.1457	39.0	70.0	3.70
A100N26	N26	3.73	0.1470	39.0	70.0	3.73
A1003.75	—	3.75	0.1476	39.0	70.0	3.75
A1003.8	—	3.80	0.1496	43.0	75.0	3.80
A100N25	N25	3.80	0.1495	43.0	75.0	3.80
A100N24	N24	3.86	0.1520	43.0	75.0	3.86
A1003.9	—	3.90	0.1535	43.0	75.0	3.90
A100N23	N23	3.91	0.1540	43.0	75.0	3.91
A1005/32	5/32	3.97	0.1563	43.0	75.0	3.97
A100N22	N22	3.99	0.1570	43.0	75.0	3.99
A1004.0	—	4.00	0.1575	43.0	75.0	4.00
A100N21	N21	4.04	0.1590	43.0	75.0	4.04
A100N20	N20	4.09	0.1610	43.0	75.0	4.09
A1004.1	—	4.10	0.1614	43.0	75.0	4.10
A1004.2	—	4.20	0.1654	43.0	75.0	4.20
A100N19	N19	4.22	0.1660	43.0	75.0	4.22
A1004.25	—	4.25	0.1673	43.0	75.0	4.25
A1004.3	—	4.30	0.1693	47.0	80.0	4.30
A100N18	N18	4.31	0.1695	47.0	80.0	4.31
A10011/64	11/64	4.37	0.1719	47.0	80.0	4.37
A100N17	N17	4.39	0.1730	47.0	80.0	4.39
A1004.4	—	4.40	0.1732	47.0	80.0	4.40
A1004.5	—	4.50	0.1772	47.0	80.0	4.50
A100N16	N16	4.50	0.1770	47.0	80.0	4.50
A100N15	N15	4.57	0.1800	47.0	80.0	4.57
A1004.6	—	4.60	0.1811	47.0	80.0	4.60



Product	DC	DC	DC	LCF	OAL	D CON MS
	[inch]	[mm]	[inch]	[mm]	[mm]	[mm]
A100N14	N14	4.62	0.1820	47.0	80.0	4.62
A1004.7	—	4.70	0.1850	47.0	80.0	4.70
A100N13	N13	4.70	0.1850	47.0	80.0	4.70
A1004.75	—	4.75	0.1870	47.0	80.0	4.75
A1003/16	3/16	4.76	0.1875	52.0	86.0	4.76
A1004.8	—	4.80	0.1890	52.0	86.0	4.80
A100N12	N12	4.80	0.1890	52.0	86.0	4.80
A100N11	N11	4.85	0.1910	52.0	86.0	4.85
A1004.9	—	4.90	0.1929	52.0	86.0	4.90
A100N10	N10	4.92	0.1935	52.0	86.0	4.92
A100N9	N9	4.98	0.1960	52.0	86.0	4.98
A1005.0	—	5.00	0.1969	52.0	86.0	5.00
A100N8	N8	5.06	0.1990	52.0	86.0	5.06
A1005.1	—	5.10	0.2008	52.0	86.0	5.10
A100N7	N7	5.11	0.2010	52.0	86.0	5.11
A10013/64	13/64	5.16	0.2031	52.0	86.0	5.16
A100N6	N6	5.18	0.2040	52.0	86.0	5.18
A1005.2	—	5.20	0.2047	52.0	86.0	5.20
A100N5	N5	5.22	0.2055	52.0	86.0	5.22
A1005.25	—	5.25	0.2067	52.0	86.0	5.25
A1005.3	—	5.30	0.2087	52.0	86.0	5.30
A100N4	N4	5.31	0.2090	57.0	93.0	5.31
A1005.4	—	5.40	0.2126	57.0	93.0	5.40
A100N3	N3	5.41	0.2130	57.0	93.0	5.41
A1005.5	—	5.50	0.2165	57.0	93.0	5.50
A1007/32	7/32	5.56	0.2188	57.0	93.0	5.56
A1005.6	—	5.60	0.2205	57.0	93.0	5.60
A100N2	N2	5.61	0.2210	57.0	93.0	5.61
A1005.7	—	5.70	0.2244	57.0	93.0	5.70
A1005.75	—	5.75	0.2264	57.0	93.0	5.75
A100N1	1	5.79	0.2280	57.0	93.0	5.79
A1005.8	—	5.80	0.2283	57.0	93.0	5.80
A1005.9	—	5.90	0.2323	57.0	93.0	5.90
A100A	A	5.94	0.2340	57.0	93.0	5.94
A10015/64	15/64	5.95	0.2344	57.0	93.0	5.95
A1006.0	—	6.00	0.2362	57.0	93.0	6.00
A100B	B	6.03	0.2380	63.0	101.0	6.03
A1006.1	—	6.10	0.2402	63.0	101.0	6.10
A100C	C	6.15	0.2420	63.0	101.0	6.15
A1006.2	—	6.20	0.2441	63.0	101.0	6.20
A1006.25	—	6.25	0.2461	63.0	101.0	6.25
A100D	D	6.25	0.2460	63.0	101.0	6.25
A1006.3	—	6.30	0.2480	63.0	101.0	6.30
A1001/4	1/4	6.35	0.2500	63.0	101.0	6.35
A100E	E	6.35	0.2500	63.0	101.0	6.35
A1006.4	—	6.40	0.2520	63.0	101.0	6.40
A1006.5	—	6.50	0.2559	63.0	101.0	6.50
A100F	F	6.53	0.2570	63.0	101.0	6.53
A1006.6	—	6.60	0.2598	63.0	101.0	6.60
A100G	G	6.63	0.2610	63.0	101.0	6.63
A1006.7	—	6.70	0.2638	63.0	101.0	6.70
A10017/64	17/64	6.75	0.2656	69.0	109.0	6.75
A1006.75	—	6.75	0.2657	69.0	109.0	6.75
A100H	H	6.76	0.2660	69.0	109.0	6.76
A1006.8	—	6.80	0.2677	69.0	109.0	6.80
A1006.9	—	6.90	0.2717	69.0	109.0	6.90
A100I	I	6.91	0.2720	69.0	109.0	6.91
A1007.0	—	7.00	0.2756	69.0	109.0	7.00
A100J	J	7.04	0.2770	69.0	109.0	7.04
A1007.1	—	7.10	0.2795	69.0	109.0	7.10
A1009/32	9/32	7.14	0.2813	69.0	109.0	7.14
A100K	K	7.14	0.2810	69.0	109.0	7.14
A1007.2	—	7.20	0.2835	69.0	109.0	7.20
A1007.25	—	7.25	0.2854	69.0	109.0	7.25
A1007.3	—	7.30	0.2874	69.0	109.0	7.30
A100L	L	7.37	0.2900	69.0	109.0	7.37
A1007.4	—	7.40	0.2913	69.0	109.0	7.40
A100M	M	7.49	0.2949	69.0	109.0	7.49
A1007.5	—	7.50	0.2953	69.0	109.0	7.50
A10019/64	19/64	7.54	0.2969	75.0	117.0	7.54
A1007.6	—	7.60	0.2992	75.0	117.0	7.60
A100N	N	7.67	0.3020	75.0	117.0	7.67
A1007.7	—	7.70	0.3031	75.0	117.0	7.70
A1007.75	—	7.75	0.3051	75.0	117.0	7.75
A1007.8	—	7.80	0.3071	75.0	117.0	7.80
A1007.9	—	7.90	0.3110	75.0	117.0	7.90
A1005/16	5/16	7.94	0.3125	75.0	117.0	7.94
A1008.0	—	8.00	0.3150	75.0	117.0	8.00
A100O	O	8.03	0.3160	75.0	117.0	8.03
A1008.1	—	8.10	0.3189	75.0	117.0	8.10
A1008.2	—	8.20	0.3228	75.0	117.0	8.20
A100P	P	8.20	0.3230	75.0	117.0	8.20
A1008.25	—	8.25	0.3248	75.0	117.0	8.25
A1008.3	—	8.30	0.3268	75.0	117.0	8.30
A10021/64	21/64	8.33	0.3281	75.0	117.0	8.33
A1008.4	—	8.40	0.3307	75.0	117.0	8.40
A100Q	Q	8.43	0.3320	75.0	117.0	8.43
A1008.5	—	8.50	0.3346	75.0	117.0	8.50
A1008.6	—	8.60	0.3386	81.0	125.0	8.60
A100R	R	8.61	0.3390	81.0	125.0	8.61
A1008.7	—	8.70	0.3425	81.0	125.0	8.70
A10011/32	11/32	8.73	0.3438	81.0	125.0	8.73
A1008.75	—	8.75	0.3445	81.0	125.0	8.75
A1008.8	—	8.80	0.3465	81.0	125.0	8.80
A100S	S	8.84	0.3480	81.0	125.0	8.84
A1008.9	—	8.90	0.3504	81.0	125.0	8.90
A1009.0	—	9.00	0.3543	81.0	125.0	9.00
A100T	T	9.09	0.3580	81.0	125.0	9.09
A1009.1	—	9.10	0.3583	81.0	125.0	9.10
A10023/64	23/64	9.13	0.3594	81.0	125.0	9.13
A1009.2	—	9.20	0.3622	81.0	125.0	9.20
A1009.25	—	9.25	0.3642	81.0	125.0	9.25
A1009.3	—	9.30	0.3661	81.0	125.0	9.30
A100U	U	9.35	0.3680	81.0	125.0	9.35
A1009.4	—	9.40	0.3701	81.0	125.0	9.40
A1009.5	—	9.50	0.3740	81.0	125.0	9.50
A1003/8	3/8	9.52	0.3750	87.0	133.0	9.52
A100V	V	9.58	0.3770	87.0	133.0	9.58
A1009.6	—	9.60	0.3780	87.0	133.0	9.60
A1009.7	—	9.70	0.3819	87.0	133.0	9.70
A1009.75	—	9.75	0.3839	87.0	133.0	9.75
A1009.8	—	9.80	0.3858	87.0	133.0	9.80
A100W	W	9.80	0.3860	87.0	133.0	9.80
A1009.9	—	9.90	0.3898	87.0	133.0	9.90
A10025/64	25/64	9.92	0.3906	87.0	133.0	9.92
A10010.0	—	10.00	0.3937	87.0	133.0	10.00
A100X	X	10.08	0.3970	87.0	133.0	10.08
A10010.1	—	10.10	0.3976	87.0	133.0	10.10
A10010.2	—	10.20	0.4016	87.0	133.0	10.20
A10010.25	—	10.25	0.4035	87.0	133.0	10.25
A100Y	Y	10.26	0.4040	87.0	133.0	10.26
A10010.3	—	10.30	0.4055	87.0	133.0	10.30
A10013/32	13/32	10.32	0.4063	87.0	133.0	10.32
A10010.4	—	10.40	0.4094	87.0	133.0	10.40



Product	DC	DC	DC	LCF	OAL	D CON MS
	[inch]	[mm]	[inch]	[mm]	[mm]	[mm]
A100Z	Z	10.49	0.4130	87.0	133.0	10.49
A10010.5	–	10.50	0.4134	87.0	133.0	10.50
A10010.6	–	10.60	0.4173	87.0	133.0	10.60
A10010.7	–	10.70	0.4213	94.0	142.0	10.70
A10027/64	27/64	10.72	0.4219	94.0	142.0	10.72
A10010.75	–	10.75	0.4232	94.0	142.0	10.75
A10010.8	–	10.80	0.4252	94.0	142.0	10.80
A10010.9	–	10.90	0.4291	94.0	142.0	10.90
A10011.0	–	11.00	0.4331	94.0	142.0	11.00
A10011.1	–	11.10	0.4370	94.0	142.0	11.10
A1007/16	7/16	11.11	0.4375	94.0	142.0	11.11
A10011.2	–	11.20	0.4409	94.0	142.0	11.20
A10011.25	–	11.25	0.4429	94.0	142.0	11.25
A10011.3	–	11.30	0.4449	94.0	142.0	11.30
A10011.4	–	11.40	0.4488	94.0	142.0	11.40
A10011.5	–	11.50	0.4528	94.0	142.0	11.50
A10029/64	29/64	11.51	0.4531	94.0	142.0	11.51
A10011.6	–	11.60	0.4567	94.0	142.0	11.60
A10011.7	–	11.70	0.4606	94.0	142.0	11.70
A10011.75	–	11.75	0.4626	94.0	142.0	11.75
A10011.8	–	11.80	0.4646	94.0	142.0	11.80
A10011.9	–	11.90	0.4685	101.0	151.0	11.90
A10015/32	15/32	11.91	0.4688	101.0	151.0	11.91
A10012.0	–	12.00	0.4724	101.0	151.0	12.00
A10012.1	–	12.10	0.4764	101.0	151.0	12.10
A10012.2	–	12.20	0.4803	101.0	151.0	12.20
A10012.25	–	12.25	0.4823	101.0	151.0	12.25
A10012.3	–	12.30	0.4843	101.0	151.0	12.30
A10031/64	31/64	12.30	0.4844	101.0	151.0	12.30
A10012.4	–	12.40	0.4882	101.0	151.0	12.40
A10012.5	–	12.50	0.4921	101.0	151.0	12.50
A10012.6	–	12.60	0.4961	101.0	151.0	12.60
A10012.7	–	12.70	0.5000	101.0	151.0	12.70
A1001/2	1/2	12.70	0.5000	101.0	151.0	12.70
A10012.75	–	12.75	0.5020	101.0	151.0	12.75
A10012.8	–	12.80	0.5039	101.0	151.0	12.80
A10012.9	–	12.90	0.5079	101.0	151.0	12.90
A10013.0	–	13.00	0.5118	101.0	151.0	13.00
A10033/64	33/64	13.10	0.5156	101.0	151.0	13.10

Product	DC	DC	DC	LCF	OAL	D CON MS
	[inch]	[mm]	[inch]	[mm]	[mm]	[mm]
A10013.1	–	13.10	0.5157	101.0	151.0	13.10
A10013.2	–	13.20	0.5197	101.0	151.0	13.20
A10013.25	–	13.25	0.5217	108.0	160.0	13.25
A10013.3	–	13.30	0.5236	108.0	160.0	13.30
A10013.4	–	13.40	0.5276	108.0	160.0	13.40
A10017/32	17/32	13.49	0.5313	108.0	160.0	13.49
A10013.5	–	13.50	0.5315	108.0	160.0	13.50
A10013.6	–	13.60	0.5354	108.0	160.0	13.60
A10013.7	–	13.70	0.5394	108.0	160.0	13.70
A10013.75	–	13.75	0.5413	108.0	160.0	13.75
A10013.8	–	13.80	0.5433	108.0	160.0	13.80
A10035/64	35/64	13.89	0.5469	108.0	160.0	13.89
A10013.9	–	13.90	0.5472	108.0	160.0	13.90
A10014.0	–	14.00	0.5512	108.0	160.0	14.00
A10014.25	–	14.25	0.5610	114.0	169.0	14.25
A1009/16	9/16	14.29	0.5625	114.0	169.0	14.29
A10014.5	–	14.50	0.5709	114.0	169.0	14.50
A10037/64	37/64	14.68	0.5781	114.0	169.0	14.68
A10014.75	–	14.75	0.5807	114.0	169.0	14.75
A10015.0	–	15.00	0.5906	114.0	169.0	15.00
A10019/32	19/32	15.08	0.5938	120.0	178.0	15.08
A10015.25	–	15.25	0.6004	120.0	178.0	15.25
A10039/64	39/64	15.48	0.6094	120.0	178.0	15.48
A10015.5	–	15.50	0.6102	120.0	178.0	15.50
A10015.75	–	15.75	0.6201	120.0	178.0	15.75
A1005/8	5/8	15.88	0.6250	120.0	178.0	15.88
A10016.0	–	16.00	0.6299	120.0	178.0	16.00
A10041/64	41/64	16.27	0.6406	125.0	184.0	16.27
A10016.5	–	16.50	0.6496	125.0	184.0	16.50
A10021/32	21/32	16.67	0.6563	125.0	184.0	16.67
A10017.0	–	17.00	0.6693	125.0	184.0	17.00
A10043/64	43/64	17.07	0.6719	130.0	191.0	17.07
A10011/16	11/16	17.46	0.6875	130.0	191.0	17.46
A10017.5	–	17.50	0.6890	130.0	191.0	17.50
A10018.0	–	18.00	0.7087	130.0	191.0	18.00
A10018.5	–	18.50	0.7283	135.0	198.0	18.50
A10019.0	–	19.00	0.7480	135.0	198.0	19.00
A10019.5	–	19.50	0.7677	140.0	205.0	19.50
A10020.0	–	20.00	0.7874	140.0	205.0	20.00



A101



HSS Left-Hand Jobber Drill, Steam Tempered Finish

Versatile left-handed drill with steam tempered finish for hand-held and machine drilling. Conventional 118° point provides strength and is easy to regrind, making it very cost-effective. Steam tempered finish retains cutting fluid and prevents chip to tool welding. Suitable for drilling many materials.

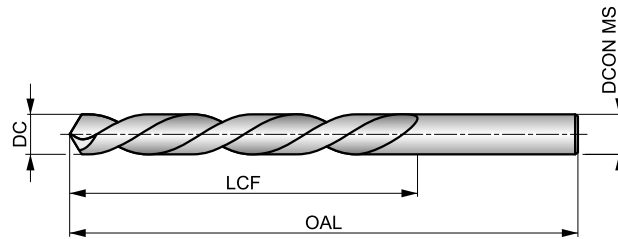

HSS	DIN 338	4×D
118°	ST	
20-35°	L	DC h8

Workpiece material group suitability, starting values for cutting speed (m/min) and feed Alpha Code. Tables with feed per revolution can be found starting from page 175.

P1.1 ■ 33 H	P1.2 ■ 37 H	P1.3 ■ 38 H	P2.1 ■ 28 H	P2.2 ■ 25 F	P2.3 ■ 22 E	P3.1 ■ 19 F	P3.2 ■ 15 F	P3.3 ■ 13 E	P4.1 ■ 11 F	P4.2 ■ 10 E	P4.3 ■ 8 D	M1.1 ■ 21 E	M1.2 ■ 17 E
M2.1 ■ 18 E	M2.2 ■ 15 E	M3.1 ■ 9 G	M3.2 ■ 8 G	M3.3 ■ 7 G	M4.1 ■ 9 C	K1.1 ■ 30 H	K1.2 ■ 22 F	K1.3 ■ 17 F	K2.1 ■ 25 E	K2.2 ■ 20 E	K2.3 ■ 16 E	K3.1 ■ 22 E	K3.2 ■ 17 E
K3.3 ■ 13 E	K4.1 ■ 20 E	K4.2 ■ 15 E	K4.3 ■ 11 E	K4.4 ■ 10 E	K4.5 ■ 8 E	K5.1 ■ 23 E	K5.2 ■ 17 E	K5.3 ■ 13 E	N1.1 ■ 33 J	N1.2 ■ 25 J	N1.3 ■ 17 I	N2.1 ■ 42 H	N2.2 ■ 37 H
N2.3 ■ 27 H	N3.1 ■ 59 H	N3.2 ■ 35 I	N3.3 ■ 18 G	N4.1 ■ 30 J	N4.2 ■ 28 H	N4.3 ■ 14 F	S1.1 ■ 23 E	S1.2 ■ 12 D	S1.3 ■ 6 B	S2.1 ■ 8 E	S2.2 ■ 4 A	S3.1 ■ 6 E	S3.2 ■ 3 A
S4.1 ■ 5 E	S4.2 ■ 2 A												

DC ≤ 3mm Bright.

Product	DC	DC	LCF	OAL	DCON MS	Product	DC	DC	LCF	OAL	DCON MS
	[mm]	[inch]					[mm]	[mm]			
A1011.0	1.00	0.0394	12.0	34.0	1.00	A1013.2	3.20	0.1260	36.0	65.0	3.20
A1011.1	1.10	0.0433	14.0	36.0	1.10	A1013.3	3.30	0.1299	36.0	65.0	3.30
A1011.2	1.20	0.0472	16.0	38.0	1.20	A1013.5	3.50	0.1378	39.0	70.0	3.50
A1011.25	1.25	0.0492	16.0	38.0	1.25	A1013.8	3.80	0.1496	43.0	75.0	3.80
A1011.3	1.30	0.0512	16.0	38.0	1.30	A1014.0	4.00	0.1575	43.0	75.0	4.00
A1011.4	1.40	0.0551	18.0	40.0	1.40	A1014.2	4.20	0.1654	43.0	75.0	4.20
A1011.5	1.50	0.0591	18.0	40.0	1.50	A1014.5	4.50	0.1772	47.0	80.0	4.50
A1011.6	1.60	0.0630	20.0	43.0	1.60	A1014.8	4.80	0.1890	52.0	86.0	4.80
A1011.7	1.70	0.0669	20.0	43.0	1.70	A1015.0	5.00	0.1969	52.0	86.0	5.00
A1011.8	1.80	0.0709	22.0	46.0	1.80	A1015.1	5.10	0.2008	52.0	86.0	5.10
A1011.9	1.90	0.0748	22.0	46.0	1.90	A1015.2	5.20	0.2047	52.0	86.0	5.20
A1012.0	2.00	0.0787	24.0	49.0	2.00	A1015.5	5.50	0.2165	57.0	93.0	5.50
A1012.1	2.10	0.0827	24.0	49.0	2.10	A1016.0	6.00	0.2362	57.0	93.0	6.00
A1012.2	2.20	0.0866	27.0	53.0	2.20	A1016.5	6.50	0.2559	63.0	101.0	6.50
A1012.3	2.30	0.0906	27.0	53.0	2.30	A1017.0	7.00	0.2756	69.0	109.0	7.00
A1012.4	2.40	0.0945	30.0	57.0	2.40	A1017.5	7.50	0.2953	69.0	109.0	7.50
A1012.5	2.50	0.0984	30.0	57.0	2.50	A1018.0	8.00	0.3150	75.0	117.0	8.00
A1012.6	2.60	0.1024	30.0	57.0	2.60	A1018.5	8.50	0.3346	75.0	117.0	8.50
A1012.7	2.70	0.1063	33.0	61.0	2.70	A1019.0	9.00	0.3543	81.0	125.0	9.00
A1012.8	2.80	0.1102	33.0	61.0	2.80	A10110.0	10.00	0.3937	87.0	133.0	10.00
A1012.9	2.90	0.1142	33.0	61.0	2.90	A10111.0	11.00	0.4331	94.0	142.0	11.00
A1013.0	3.00	0.1181	33.0	61.0	3.00	A10112.0	12.00	0.4724	101.0	151.0	12.00



A108



HSS Jobber Drill, Steam Tempered Finish (Designed for Stainless Steel)

First choice when drilling stainless steel with hand-held applications, but can also be used effectively in machines. The 135° split point helps to self-center and reduces the cutting forces. Steam tempered finish helps stop workpiece material from sticking to the cutting edge.

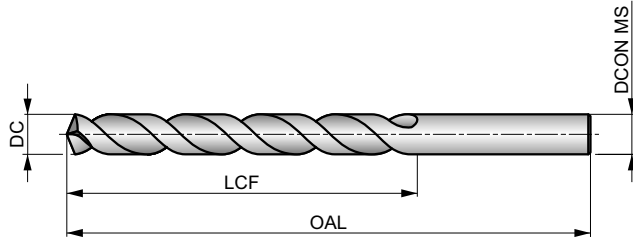

HSS	DIN 338	4xD
135°	ST	
λ > 35°	R	DC h8

Workpiece material group suitability, starting values for cutting speed (m/min) and feed Alpha Code. Tables with feed per revolution can be found starting from page 175.

P1.1 □33 I	P1.2 □37 I	P1.3 □38 I	P2.1 □28 I	P2.2 □25 G	P2.3 □22 E	P3.1 □19 F	P3.2 □15 F	P3.3 □13 E	P4.1 □11 F	P4.2 □10 E	P4.3 □8 D	M1.1 □21 E	M1.2 □17 E
M2.1 □18 E	M2.2 □15 E	M3.1 ■10 G	M3.2 ■9 G	M3.3 ■8 G	M4.1 ■10 D	K1.1 □30 H	K1.2 □22 F	K1.3 □17 F	K2.1 □25 E	K2.2 □20 E	K2.3 □16 E	K3.1 □22 E	K3.2 □17 E
K3.3 □13 E	K4.1 □20 E	K4.2 □15 E	K4.3 □11 E	K4.4 □10 E	K4.5 □8 E	K5.1 □23 E	K5.2 □17 E	K5.3 □13 E	N1.1 □33 J	N1.2 □25 J	N1.3 □17 I	N2.1 □42 H	N2.2 □37 H
N2.3 □27 H	N3.1 □59 H	N3.2 □35 I	N3.3 □18 G	N4.1 □30 J	N4.2 □28 H	N4.3 □14 F	S1.1 ■25 G	S1.2 ■16 E	S1.3 □7 B	S2.1 □9 G	S2.2 □8 E	S3.1 □7 G	S3.2 □6 E
S4.1 □5 G	S4.2 □5 E												

DC > 1.5mm (1/16") Split Point.

Products from this series are also available in set. Please see A188.

Product	DC [inch]	DC [mm]	DC [inch]	LCF [mm]	OAL [mm]	DCON MS [mm]
A1081.0	—	1.00	0.0394	12.0	34.0	1.00
A1081.1	—	1.10	0.0433	14.0	36.0	1.10
A1081.2	—	1.20	0.0472	16.0	38.0	1.20
A1081.3	—	1.30	0.0512	16.0	38.0	1.30
A1081.4	—	1.40	0.0551	18.0	40.0	1.40
A1081.5	—	1.50	0.0591	18.0	40.0	1.50
A1081/16	1/16	1.59	0.0625	20.0	43.0	1.59
A1081.6	—	1.60	0.0630	20.0	43.0	1.60
A1081.7	—	1.70	0.0669	20.0	43.0	1.70
A1081.8	—	1.80	0.0709	22.0	46.0	1.80
A1081.9	—	1.90	0.0748	22.0	46.0	1.90
A1085/64	5/64	1.98	0.0781	24.0	49.0	1.98
A1082.0	—	2.00	0.0787	24.0	49.0	2.00
A1082.1	—	2.10	0.0827	24.0	49.0	2.10
A1082.2	—	2.20	0.0866	27.0	53.0	2.20
A1082.3	—	2.30	0.0906	27.0	53.0	2.30
A1083/32	3/32	2.38	0.0938	30.0	57.0	2.38
A1082.4	—	2.40	0.0945	30.0	57.0	2.40
A1082.5	—	2.50	0.0984	30.0	57.0	2.50
A1082.6	—	2.60	0.1024	30.0	57.0	2.60
A1082.7	—	2.70	0.1063	33.0	61.0	2.70
A1087/64	7/64	2.78	0.1094	33.0	61.0	2.78

Product	DC [inch]	DC [mm]	DC [inch]	LCF [mm]	OAL [mm]	DCON MS [mm]
A1082.8	—	2.80	0.1102	33.0	61.0	2.80
A1082.9	—	2.90	0.1142	33.0	61.0	2.90
A1083.0	—	3.00	0.1181	33.0	61.0	3.00
A1083.1	—	3.10	0.1220	36.0	65.0	3.10
A1081/8	1/8	3.18	0.1250	36.0	65.0	3.18
A1083.2	—	3.20	0.1260	36.0	65.0	3.20
A1083.3	—	3.30	0.1299	36.0	65.0	3.30
A1083.4	—	3.40	0.1339	39.0	70.0	3.40
A1083.5	—	3.50	0.1378	39.0	70.0	3.50
A1089/64	9/64	3.57	0.1406	39.0	70.0	3.57
A1083.6	—	3.60	0.1417	39.0	70.0	3.60
A1083.7	—	3.70	0.1457	39.0	70.0	3.70
A1083.8	—	3.80	0.1496	43.0	75.0	3.80
A1083.9	—	3.90	0.1535	43.0	75.0	3.90
A1085/32	5/32	3.97	0.1563	43.0	75.0	3.97
A1084.0	—	4.00	0.1575	43.0	75.0	4.00
A1084.1	—	4.10	0.1614	43.0	75.0	4.10
A1084.2	—	4.20	0.1654	43.0	75.0	4.20
A1084.3	—	4.30	0.1693	47.0	80.0	4.30
A10811/64	11/64	4.37	0.1719	47.0	80.0	4.37
A1084.4	—	4.40	0.1732	47.0	80.0	4.40
A1084.5	—	4.50	0.1772	47.0	80.0	4.50



Product	DC	DC	DC	LCF	OAL	DCON MS
	[inch]	[mm]	[inch]	[mm]	[mm]	[mm]
A1084.6	–	4.60	0.1811	47.0	80.0	4.60
A1084.7	–	4.70	0.1850	47.0	80.0	4.70
A1083/16	3/16	4.76	0.1875	52.0	86.0	4.76
A1084.8	–	4.80	0.1890	52.0	86.0	4.80
A1084.9	–	4.90	0.1929	52.0	86.0	4.90
A108N10	N10	4.92	0.1935	52.0	86.0	4.92
A1085.0	–	5.00	0.1969	52.0	86.0	5.00
A1085.1	–	5.10	0.2008	52.0	86.0	5.10
A10813/64	13/64	5.16	0.2031	52.0	86.0	5.16
A1085.2	–	5.20	0.2047	52.0	86.0	5.20
A1085.3	–	5.30	0.2087	52.0	86.0	5.30
A1085.4	–	5.40	0.2126	57.0	93.0	5.40
A1085.5	–	5.50	0.2165	57.0	93.0	5.50
A1087/32	7/32	5.56	0.2188	57.0	93.0	5.56
A1085.6	–	5.60	0.2205	57.0	93.0	5.60
A1085.7	–	5.70	0.2244	57.0	93.0	5.70
A1085.8	–	5.80	0.2283	57.0	93.0	5.80
A1085.9	–	5.90	0.2323	57.0	93.0	5.90
A10815/64	15/64	5.95	0.2344	57.0	93.0	5.95
A1086.0	–	6.00	0.2362	57.0	93.0	6.00
A1086.1	–	6.10	0.2402	63.0	101.0	6.10
A1086.2	–	6.20	0.2441	63.0	101.0	6.20
A1086.3	–	6.30	0.2480	63.0	101.0	6.30
A1081/4	1/4	6.35	0.2500	63.0	101.0	6.35
A1086.4	–	6.40	0.2520	63.0	101.0	6.40
A1086.5	–	6.50	0.2559	63.0	101.0	6.50
A1086.6	–	6.60	0.2598	63.0	101.0	6.60
A1086.7	–	6.70	0.2638	63.0	101.0	6.70
A10817/64	17/64	6.75	0.2656	69.0	109.0	6.75
A1086.8	–	6.80	0.2677	69.0	109.0	6.80
A1086.9	–	6.90	0.2717	69.0	109.0	6.90
A1087.0	–	7.00	0.2756	69.0	109.0	7.00
A1087.1	–	7.10	0.2795	69.0	109.0	7.10
A1089/32	9/32	7.14	0.2813	69.0	109.0	7.14
A1087.2	–	7.20	0.2835	69.0	109.0	7.20
A1087.3	–	7.30	0.2874	69.0	109.0	7.30
A1087.4	–	7.40	0.2913	69.0	109.0	7.40
A1087.5	–	7.50	0.2953	69.0	109.0	7.50
A10819/64	19/64	7.54	0.2969	75.0	117.0	7.54
A1087.6	–	7.60	0.2992	75.0	117.0	7.60
A1087.7	–	7.70	0.3031	75.0	117.0	7.70
A1087.8	–	7.80	0.3071	75.0	117.0	7.80
A1087.9	–	7.90	0.3110	75.0	117.0	7.90
A1085/16	5/16	7.94	0.3125	75.0	117.0	7.94
A1088.0	–	8.00	0.3150	75.0	117.0	8.00
A1088.1	–	8.10	0.3189	75.0	117.0	8.10
A1088.2	–	8.20	0.3228	75.0	117.0	8.20
A1088.3	–	8.30	0.3268	75.0	117.0	8.30

Product	DC	DC	DC	LCF	OAL	DCON MS
	[inch]	[mm]	[inch]	[mm]	[mm]	[mm]
A10821/64	21/64	8.33	0.3281	75.0	117.0	8.33
A1088.4	–	8.40	0.3307	75.0	117.0	8.40
A1088.5	–	8.50	0.3346	75.0	117.0	8.50
A1088.6	–	8.60	0.3386	81.0	125.0	8.60
A1088.7	–	8.70	0.3425	81.0	125.0	8.70
A10811/32	11/32	8.73	0.3438	81.0	125.0	8.73
A1088.8	–	8.80	0.3465	81.0	125.0	8.80
A1088.9	–	8.90	0.3504	81.0	125.0	8.90
A1089.0	–	9.00	0.3543	81.0	125.0	9.00
A1089.1	–	9.10	0.3583	81.0	125.0	9.10
A10823/64	23/64	9.13	0.3594	81.0	125.0	9.13
A1089.2	–	9.20	0.3622	81.0	125.0	9.20
A1089.3	–	9.30	0.3661	81.0	125.0	9.30
A1089.4	–	9.40	0.3701	81.0	125.0	9.40
A1089.5	–	9.50	0.3740	81.0	125.0	9.50
A1083/8	3/8	9.52	0.3750	87.0	133.0	9.52
A1089.6	–	9.60	0.3780	87.0	133.0	9.60
A1089.7	–	9.70	0.3819	87.0	133.0	9.70
A1089.8	–	9.80	0.3858	87.0	133.0	9.80
A1089.9	–	9.90	0.3898	87.0	133.0	9.90
A10825/64	25/64	9.92	0.3906	87.0	133.0	9.92
A10810.0	–	10.00	0.3937	87.0	133.0	10.00
A10810.2	–	10.20	0.4016	87.0	133.0	10.20
A10813/32	13/32	10.32	0.4063	87.0	133.0	10.32
A10810.5	–	10.50	0.4134	87.0	133.0	10.50
A10827/64	27/64	10.72	0.4219	94.0	142.0	10.72
A10810.8	–	10.80	0.4252	94.0	142.0	10.80
A10811.0	–	11.00	0.4331	94.0	142.0	11.00
A1087/16	7/16	11.11	0.4375	94.0	142.0	11.11
A10811.5	–	11.50	0.4528	94.0	142.0	11.50
A10829/64	29/64	11.51	0.4531	94.0	142.0	11.51
A10811.8	–	11.80	0.4646	94.0	142.0	11.80
A10815/32	15/32	11.91	0.4688	101.0	151.0	11.91
A10812.0	–	12.00	0.4724	101.0	151.0	12.00
A10812.2	–	12.20	0.4803	101.0	151.0	12.20
A10831/64	31/64	12.30	0.4844	101.0	151.0	12.30
A10812.5	–	12.50	0.4921	101.0	151.0	12.50
A1081/2	1/2	12.70	0.5000	101.0	151.0	12.70
A10812.8	–	12.80	0.5039	101.0	151.0	12.80
A10812.9	–	12.90	0.5079	101.0	151.0	12.90
A10813.0	–	13.00	0.5118	101.0	151.0	13.00
A10813.5	–	13.50	0.5315	108.0	160.0	13.50
A10814.0	–	14.00	0.5512	108.0	160.0	14.00
A10814.5	–	14.50	0.5709	114.0	169.0	14.50
A10815.0	–	15.00	0.5906	114.0	169.0	15.00
A10815.25	–	15.25	0.6004	120.0	178.0	15.25
A10815.5	–	15.50	0.6102	120.0	178.0	15.50
A10816.0	–	16.00	0.6299	120.0	178.0	16.00



A147



HSS-E (5% Cobalt) Jobber Drill, Bright Finish (Designed for Stainless Steel)

Versatile and hard-working drill which satisfies all machine drilling requirements in stainless steels, but can also be used for hand-held operations. A 130° split point helps to self-center the drill and reduces the cutting forces. Bright finish.

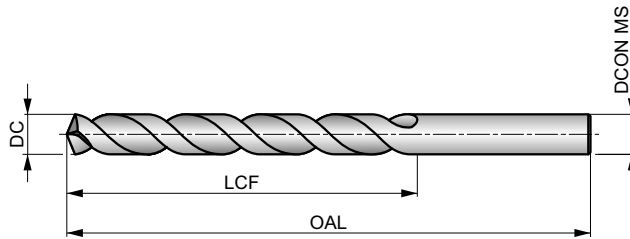

HSS-E	DIN 338	4xD
130°	Bright	
VA	R	DC h8

Workpiece material group suitability, starting values for cutting speed (m/min) and feed Alpha Code. Tables with feed per revolution can be found starting from page 175.

P1.1 33 I	P1.2 37 I	P1.3 38 I	P2.1 28 I	P2.2 25 G	P2.3 22 E	P3.1 19 F	P3.2 15 F	P3.3 13 E	P4.1 11 F	P4.2 10 E	P4.3 8 D	M1.1 21 E	M1.2 17 E
M2.1 18 E	M2.2 15 E	M2.3 13 B	M3.1 10 G	M3.2 9 G	M3.3 8 G	M4.1 10 D	M4.2 9 B	K1.1 30 H	K1.2 22 F	K1.3 17 F	K2.1 25 E	K2.2 20 E	K2.3 16 E
K3.1 22 E	K3.2 17 E	K3.3 13 E	K4.1 20 E	K4.2 15 E	K4.3 11 E	K4.4 10 E	K4.5 8 E	K5.1 23 E	K5.2 17 E	K5.3 13 E	N1.1 33 J	N1.2 25 J	N1.3 17 I
N2.1 42 H	N2.2 37 H	N2.3 27 H	N3.1 59 H	N3.2 35 I	N3.3 18 G	N4.1 30 J	N4.2 28 H	N4.3 14 F	S1.1 25 G	S1.2 16 E	S1.3 7 B	S2.1 9 G	S2.2 8 E
S3.1 7 G	S3.2 6 E	S4.1 5 G	S4.2 5 E										

Product	DC [inch]	DC [mm]	DC [inch]	LCF [mm]	OAL [mm]	DCON MS [mm]
A147.3	–	0.30	0.0118	3.0	19.0	0.30
A147.4	–	0.40	0.0157	5.0	20.0	0.40
A147.5	–	0.50	0.0197	6.0	22.0	0.50
A147.6	–	0.60	0.0236	7.0	24.0	0.60
A147.7	–	0.70	0.0276	9.0	28.0	0.70
A147.8	–	0.80	0.0315	10.0	30.0	0.80
A147.9	–	0.90	0.0354	11.0	32.0	0.90
A1471.0	–	1.00	0.0394	12.0	34.0	1.00
A1471.1	–	1.10	0.0433	14.0	36.0	1.10
A1471.2	–	1.20	0.0472	16.0	38.0	1.20
A1471.3	–	1.30	0.0512	16.0	38.0	1.30
A1471.4	–	1.40	0.0551	18.0	40.0	1.40
A1471.5	–	1.50	0.0591	18.0	40.0	1.50
A1471/16	1/16	1.59	0.0625	20.0	43.0	1.59
A1471.6	–	1.60	0.0630	20.0	43.0	1.60
A1471.7	–	1.70	0.0669	20.0	43.0	1.70
A1471.8	–	1.80	0.0709	22.0	46.0	1.80
A1471.9	–	1.90	0.0748	22.0	46.0	1.90
A1472.0	–	2.00	0.0787	24.0	49.0	2.00
A1472.1	–	2.10	0.0827	24.0	49.0	2.10
A1472.2	–	2.20	0.0866	27.0	53.0	2.20
A1472.3	–	2.30	0.0906	27.0	53.0	2.30
A1473/32	3/32	2.38	0.0938	30.0	57.0	2.38
A1472.4	–	2.40	0.0945	30.0	57.0	2.40

Product	DC [inch]	DC [mm]	DC [inch]	LCF [mm]	OAL [mm]	DCON MS [mm]
A1472.5	–	2.50	0.0984	30.0	57.0	2.50
A1472.6	–	2.60	0.1024	30.0	57.0	2.60
A1472.7	–	2.70	0.1063	33.0	61.0	2.70
A1472.8	–	2.80	0.1102	33.0	61.0	2.80
A1472.9	–	2.90	0.1142	33.0	61.0	2.90
A1473.0	–	3.00	0.1181	33.0	61.0	3.00
A1473.1	–	3.10	0.1220	36.0	65.0	3.10
A1471/8	1/8	3.18	0.1250	36.0	65.0	3.18
A1473.2	–	3.20	0.1260	36.0	65.0	3.20
A1473.3	–	3.30	0.1299	36.0	65.0	3.30
A1473.4	–	3.40	0.1339	39.0	70.0	3.40
A1473.5	–	3.50	0.1378	39.0	70.0	3.50
A1473.6	–	3.60	0.1417	39.0	70.0	3.60
A1473.7	–	3.70	0.1457	39.0	70.0	3.70
A1473.8	–	3.80	0.1496	43.0	75.0	3.80
A1473.9	–	3.90	0.1535	43.0	75.0	3.90
A1475/32	5/32	3.97	0.1563	43.0	75.0	3.97
A1474.0	–	4.00	0.1575	43.0	75.0	4.00
A1474.1	–	4.10	0.1614	43.0	75.0	4.10
A1474.2	–	4.20	0.1654	43.0	75.0	4.20
A1474.3	–	4.30	0.1693	47.0	80.0	4.30
A1474.4	–	4.40	0.1732	47.0	80.0	4.40
A1474.5	–	4.50	0.1772	47.0	80.0	4.50
A1474.6	–	4.60	0.1811	47.0	80.0	4.60



Product	DC	DC	DC	LCF	OAL	D CON MS
	[inch]	[mm]	[inch]	[mm]	[mm]	[mm]
A1474.7	–	4.70	0.1850	47.0	80.0	4.70
A1473/16	3/16	4.76	0.1875	52.0	86.0	4.76
A1474.8	–	4.80	0.1890	52.0	86.0	4.80
A1474.9	–	4.90	0.1929	52.0	86.0	4.90
A1475.0	–	5.00	0.1969	52.0	86.0	5.00
A1475.1	–	5.10	0.2008	52.0	86.0	5.10
A1475.2	–	5.20	0.2047	52.0	86.0	5.20
A1475.3	–	5.30	0.2087	52.0	86.0	5.30
A1475.4	–	5.40	0.2126	57.0	93.0	5.40
A1475.5	–	5.50	0.2165	57.0	93.0	5.50
A1475.6	–	5.60	0.2205	57.0	93.0	5.60
A1475.7	–	5.70	0.2244	57.0	93.0	5.70
A1475.8	–	5.80	0.2283	57.0	93.0	5.80
A1475.9	–	5.90	0.2323	57.0	93.0	5.90
A1476.0	–	6.00	0.2362	57.0	93.0	6.00
A1476.1	–	6.10	0.2402	63.0	101.0	6.10
A1476.2	–	6.20	0.2441	63.0	101.0	6.20
A1476.3	–	6.30	0.2480	63.0	101.0	6.30
A1471/4	1/4	6.35	0.2500	63.0	101.0	6.35
A1476.4	–	6.40	0.2520	63.0	101.0	6.40
A1476.5	–	6.50	0.2559	63.0	101.0	6.50
A1476.6	–	6.60	0.2598	63.0	101.0	6.60
A1476.7	–	6.70	0.2638	63.0	101.0	6.70
A1476.8	–	6.80	0.2677	69.0	109.0	6.80
A1476.9	–	6.90	0.2717	69.0	109.0	6.90
A1477.0	–	7.00	0.2756	69.0	109.0	7.00
A1477.1	–	7.10	0.2795	69.0	109.0	7.10
A1477.2	–	7.20	0.2835	69.0	109.0	7.20
A1477.3	–	7.30	0.2874	69.0	109.0	7.30
A1477.4	–	7.40	0.2913	69.0	109.0	7.40
A1477.5	–	7.50	0.2953	69.0	109.0	7.50
A1477.6	–	7.60	0.2992	75.0	117.0	7.60
A1477.7	–	7.70	0.3031	75.0	117.0	7.70
A1477.8	–	7.80	0.3071	75.0	117.0	7.80

Product	DC	DC	DC	LCF	OAL	D CON MS
	[inch]	[mm]	[inch]	[mm]	[mm]	[mm]
A1477.9	–	7.90	0.3110	75.0	117.0	7.90
A1478.0	–	8.00	0.3150	75.0	117.0	8.00
A1478.1	–	8.10	0.3189	75.0	117.0	8.10
A1478.2	–	8.20	0.3228	75.0	117.0	8.20
A1478.3	–	8.30	0.3268	75.0	117.0	8.30
A1478.4	–	8.40	0.3307	75.0	117.0	8.40
A1478.5	–	8.50	0.3346	75.0	117.0	8.50
A1478.6	–	8.60	0.3386	81.0	125.0	8.60
A1478.7	–	8.70	0.3425	81.0	125.0	8.70
A1478.8	–	8.80	0.3465	81.0	125.0	8.80
A1478.9	–	8.90	0.3504	81.0	125.0	8.90
A1479.0	–	9.00	0.3543	81.0	125.0	9.00
A1479.1	–	9.10	0.3583	81.0	125.0	9.10
A1479.2	–	9.20	0.3622	81.0	125.0	9.20
A1479.3	–	9.30	0.3661	81.0	125.0	9.30
A1479.4	–	9.40	0.3701	81.0	125.0	9.40
A1479.5	–	9.50	0.3740	81.0	125.0	9.50
A1479.6	–	9.60	0.3780	87.0	133.0	9.60
A1479.7	–	9.70	0.3819	87.0	133.0	9.70
A1479.8	–	9.80	0.3858	87.0	133.0	9.80
A1479.9	–	9.90	0.3898	87.0	133.0	9.90
A14710.0	–	10.00	0.3937	87.0	133.0	10.00
A14710.2	–	10.20	0.4016	87.0	133.0	10.20
A14710.5	–	10.50	0.4134	87.0	133.0	10.50
A14711.0	–	11.00	0.4331	94.0	142.0	11.00
A14711.2	–	11.20	0.4409	94.0	142.0	11.20
A14711.5	–	11.50	0.4528	94.0	142.0	11.50
A14712.0	–	12.00	0.4724	101.0	151.0	12.00
A14712.5	–	12.50	0.4921	101.0	151.0	12.50
A14713.0	–	13.00	0.5118	101.0	151.0	13.00
A14713.5	–	13.50	0.5315	108.0	160.0	13.50
A14714.0	–	14.00	0.5512	108.0	160.0	14.00
A14714.5	–	14.50	0.5709	114.0	169.0	14.50
A14715.0	–	15.00	0.5906	114.0	169.0	15.00



A777



HSS-E (8% Cobalt) Jobber Drill, Bronze Tempered Finish

A top performer, producing accurate sized holes with a quality finish in high strength materials. The 135° split point helps to self-center. The bronze finish is a thin oxide layer formed on the tool surface and is an indication for 8% Cobalt HSS-E Drill.

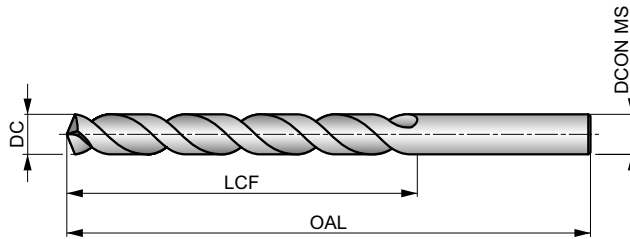

HSS-E	DIN 338	4xD
135°	Bronze	
λ 20-35°	R	DC h8

Workpiece material group suitability, starting values for cutting speed (m/min) and feed Alpha Code. Tables with feed per revolution can be found starting from page 175.

P1.1 36 H	P1.2 40 H	P1.3 41 H	P2.1 31 H	P2.2 27 G	P2.3 24 E	P3.1 25 F	P3.2 20 F	P3.3 17 E	P4.1 15 F	P4.2 13 E	P4.3 10 D	M1.1 30 E	M1.2 26 E
M2.1 27 E	M2.2 22 E	M3.1 13 G	M3.2 11 G	M3.3 10 G	M4.1 15 C	K1.1 35 H	K1.2 26 D	K1.3 19 D	K2.1 27 E	K2.2 22 E	K2.3 18 E	K3.1 24 E	K3.2 18 E
K3.3 15 E	K4.1 22 E	K4.2 17 E	K4.3 12 E	K4.4 11 E	K4.5 9 E	K5.1 25 E	K5.2 19 E	K5.3 15 E	N1.1 33 J	N1.2 25 J	N1.3 17 I	N2.1 46 H	N2.2 42 H
N2.3 30 H	N3.1 68 H	N3.2 40 F	N3.3 20 H	S1.1 28 F	S1.2 20 D	S1.3 11 C	S2.1 9 E	S2.2 8 B	S3.1 7 E	S3.2 6 B	S4.1 5 E	S4.2 5 B	

NAS907J. DC ≤ 1.4mm 4 Facet Point.
Products from this series are also available in set. Please see A295.

Product	DC [inch]	DC [mm]	DC [inch]	LCF [mm]	OAL [mm]	DCON MS [mm]
A777.3	—	0.30	0.0118	3.0	19.0	0.30
A777.35	—	0.35	0.0138	4.0	19.0	0.35
A777.4	—	0.40	0.0157	5.0	20.0	0.40
A777.45	—	0.45	0.0177	5.0	20.0	0.45
A777.5	—	0.50	0.0197	6.0	22.0	0.50
A777.55	—	0.55	0.0217	7.0	24.0	0.55
A777.6	—	0.60	0.0236	7.0	24.0	0.60
A777.65	—	0.65	0.0256	8.0	26.0	0.65
A777.7	—	0.70	0.0276	9.0	28.0	0.70
A777.8	—	0.80	0.0315	10.0	30.0	0.80
A777.9	—	0.90	0.0354	11.0	32.0	0.90
A777.95	—	0.95	0.0374	11.0	32.0	0.95
A7771.0	—	1.00	0.0394	12.0	34.0	1.00
A7771.1	—	1.10	0.0433	14.0	36.0	1.10
A7771.2	—	1.20	0.0472	16.0	38.0	1.20
A7771.3	—	1.30	0.0512	16.0	38.0	1.30
A7771.4	—	1.40	0.0551	18.0	40.0	1.40
A7771.5	—	1.50	0.0591	18.0	40.0	1.50
A7771/16	1/16	1.59	0.0625	20.0	43.0	1.59
A7771.6	—	1.60	0.0630	20.0	43.0	1.60
A7771.7	—	1.70	0.0669	20.0	43.0	1.70
A7771.8	—	1.80	0.0709	22.0	46.0	1.80
A7771.9	—	1.90	0.0748	22.0	46.0	1.90
A7775/64	5/64	1.98	0.0781	24.0	49.0	1.98

Product	DC [inch]	DC [mm]	DC [inch]	LCF [mm]	OAL [mm]	DCON MS [mm]
A7772.0	—	2.00	0.0787	24.0	49.0	2.00
A7772.1	—	2.10	0.0827	24.0	49.0	2.10
A7772.2	—	2.20	0.0866	27.0	53.0	2.20
A7772.3	—	2.30	0.0906	27.0	53.0	2.30
A7773/32	3/32	2.38	0.0938	30.0	57.0	2.38
A7772.4	—	2.40	0.0945	30.0	57.0	2.40
A7772.5	—	2.50	0.0984	30.0	57.0	2.50
A7772.6	—	2.60	0.1024	30.0	57.0	2.60
A7772.7	—	2.70	0.1063	33.0	61.0	2.70
A7777/64	7/64	2.78	0.1094	33.0	61.0	2.78
A7772.8	—	2.80	0.1102	33.0	61.0	2.80
A7772.9	—	2.90	0.1142	33.0	61.0	2.90
A7773.0	—	3.00	0.1181	33.0	61.0	3.00
A7773.1	—	3.10	0.1220	36.0	65.0	3.10
A7771/8	1/8	3.18	0.1250	36.0	65.0	3.18
A7773.2	—	3.20	0.1260	36.0	65.0	3.20
A7773.3	—	3.30	0.1299	36.0	65.0	3.30
A7773.4	—	3.40	0.1339	39.0	70.0	3.40
A7773.5	—	3.50	0.1378	39.0	70.0	3.50
A7779/64	9/64	3.57	0.1406	39.0	70.0	3.57
A7773.6	—	3.60	0.1417	39.0	70.0	3.60
A7773.7	—	3.70	0.1457	39.0	70.0	3.70
A7773.8	—	3.80	0.1496	43.0	75.0	3.80
A7773.9	—	3.90	0.1535	43.0	75.0	3.90



Product	DC	DC	DC	LCF	OAL	D CON MS
	[inch]	[mm]	[inch]	[mm]	[mm]	[mm]
A7775/32	5/32	3.97	0.1563	43.0	75.0	3.97
A7774.0	–	4.00	0.1575	43.0	75.0	4.00
A7774.1	–	4.10	0.1614	43.0	75.0	4.10
A7774.2	–	4.20	0.1654	43.0	75.0	4.20
A7774.3	–	4.30	0.1693	47.0	80.0	4.30
A77711/64	11/64	4.37	0.1719	47.0	80.0	4.37
A7774.4	–	4.40	0.1732	47.0	80.0	4.40
A7774.5	–	4.50	0.1772	47.0	80.0	4.50
A7774.6	–	4.60	0.1811	47.0	80.0	4.60
A7774.7	–	4.70	0.1850	47.0	80.0	4.70
A7773/16	3/16	4.76	0.1875	52.0	86.0	4.76
A7774.8	–	4.80	0.1890	52.0	86.0	4.80
A7774.9	–	4.90	0.1929	52.0	86.0	4.90
A7775.0	–	5.00	0.1969	52.0	86.0	5.00
A7775.1	–	5.10	0.2008	52.0	86.0	5.10
A77713/64	13/64	5.16	0.2031	52.0	86.0	5.16
A7775.2	–	5.20	0.2047	52.0	86.0	5.20
A7775.3	–	5.30	0.2087	52.0	86.0	5.30
A7775.4	–	5.40	0.2126	57.0	93.0	5.40
A7775.5	–	5.50	0.2165	57.0	93.0	5.50
A7777/32	7/32	5.56	0.2188	57.0	93.0	5.56
A7775.6	–	5.60	0.2205	57.0	93.0	5.60
A7775.7	–	5.70	0.2244	57.0	93.0	5.70
A7775.8	–	5.80	0.2283	57.0	93.0	5.80
A7775.9	–	5.90	0.2323	57.0	93.0	5.90
A77715/64	15/64	5.95	0.2344	57.0	93.0	5.95
A7776.0	–	6.00	0.2362	57.0	93.0	6.00
A7776.1	–	6.10	0.2402	63.0	101.0	6.10
A7776.2	–	6.20	0.2441	63.0	101.0	6.20
A7776.3	–	6.30	0.2480	63.0	101.0	6.30
A7771/4	1/4	6.35	0.2500	63.0	101.0	6.35
A7776.4	–	6.40	0.2520	63.0	101.0	6.40
A7776.5	–	6.50	0.2559	63.0	101.0	6.50
A7776.6	–	6.60	0.2598	63.0	101.0	6.60
A7776.7	–	6.70	0.2638	63.0	101.0	6.70
A77717/64	17/64	6.75	0.2656	69.0	109.0	6.75
A7776.8	–	6.80	0.2677	69.0	109.0	6.80
A7776.9	–	6.90	0.2717	69.0	109.0	6.90
A7777.0	–	7.00	0.2756	69.0	109.0	7.00
A7777.1	–	7.10	0.2795	69.0	109.0	7.10
A7779/32	9/32	7.14	0.2813	69.0	109.0	7.14
A7777.2	–	7.20	0.2835	69.0	109.0	7.20
A7777.3	–	7.30	0.2874	69.0	109.0	7.30
A7777.4	–	7.40	0.2913	69.0	109.0	7.40
A7777.5	–	7.50	0.2953	69.0	109.0	7.50
A77719/64	19/64	7.54	0.2969	75.0	117.0	7.54
A7777.6	–	7.60	0.2992	75.0	117.0	7.60
A7777.7	–	7.70	0.3031	75.0	117.0	7.70
A7777.8	–	7.80	0.3071	75.0	117.0	7.80
A7777.9	–	7.90	0.3110	75.0	117.0	7.90
A7775/16	5/16	7.94	0.3125	75.0	117.0	7.94
A7778.0	–	8.00	0.3150	75.0	117.0	8.00

Product	DC	DC	DC	LCF	OAL	D CON MS
	[inch]	[mm]	[inch]	[mm]	[mm]	[mm]
A7778.1	–	8.10	0.3189	75.0	117.0	8.10
A7778.2	–	8.20	0.3228	75.0	117.0	8.20
A7778.3	–	8.30	0.3268	75.0	117.0	8.30
A77721/64	21/64	8.33	0.3281	75.0	117.0	8.33
A7778.4	–	8.40	0.3307	75.0	117.0	8.40
A7778.5	–	8.50	0.3346	75.0	117.0	8.50
A7778.6	–	8.60	0.3386	81.0	125.0	8.60
A7778.7	–	8.70	0.3425	81.0	125.0	8.70
A77711/32	11/32	8.73	0.3438	81.0	125.0	8.73
A7778.8	–	8.80	0.3465	81.0	125.0	8.80
A7778.9	–	8.90	0.3504	81.0	125.0	8.90
A7779.0	–	9.00	0.3543	81.0	125.0	9.00
A7779.1	–	9.10	0.3583	81.0	125.0	9.10
A77723/64	23/64	9.13	0.3594	81.0	125.0	9.13
A7779.2	–	9.20	0.3622	81.0	125.0	9.20
A7779.3	–	9.30	0.3661	81.0	125.0	9.30
A7779.4	–	9.40	0.3701	81.0	125.0	9.40
A7779.5	–	9.50	0.3740	81.0	125.0	9.50
A7773/8	3/8	9.52	0.3750	87.0	133.0	9.52
A7779.6	–	9.60	0.3780	87.0	133.0	9.60
A7779.7	–	9.70	0.3819	87.0	133.0	9.70
A7779.8	–	9.80	0.3858	87.0	133.0	9.80
A7779.9	–	9.90	0.3898	87.0	133.0	9.90
A77725/64	25/64	9.92	0.3906	87.0	133.0	9.92
A77710.0	–	10.00	0.3937	87.0	133.0	10.00
A77710.1	–	10.10	0.3976	87.0	133.0	10.10
A77710.2	–	10.20	0.4016	87.0	133.0	10.20
A77713/32	13/32	10.32	0.4063	87.0	133.0	10.32
A77710.5	–	10.50	0.4134	87.0	133.0	10.50
A77727/64	27/64	10.72	0.4219	94.0	142.0	10.72
A77710.8	–	10.80	0.4252	94.0	142.0	10.80
A77711.0	–	11.00	0.4331	94.0	142.0	11.00
A7777/16	7/16	11.11	0.4375	94.0	142.0	11.11
A77711.2	–	11.20	0.4409	94.0	142.0	11.20
A77711.5	–	11.50	0.4528	94.0	142.0	11.50
A77729/64	29/64	11.51	0.4531	94.0	142.0	11.51
A77711.8	–	11.80	0.4646	94.0	142.0	11.80
A77715/32	15/32	11.91	0.4688	101.0	151.0	11.91
A77712.0	–	12.00	0.4724	101.0	151.0	12.00
A77712.2	–	12.20	0.4803	101.0	151.0	12.20
A77731/64	31/64	12.30	0.4844	101.0	151.0	12.30
A77712.5	–	12.50	0.4921	101.0	151.0	12.50
A7771/2	1/2	12.70	0.5000	101.0	151.0	12.70
A77712.8	–	12.80	0.5039	101.0	151.0	12.80
A77713.0	–	13.00	0.5118	101.0	151.0	13.00
A77713.5	–	13.50	0.5315	108.0	160.0	13.50
A77714.0	–	14.00	0.5512	108.0	160.0	14.00
A77714.5	–	14.50	0.5709	114.0	169.0	14.50
A77715.0	–	15.00	0.5906	114.0	169.0	15.00
A77715.5	–	15.50	0.6102	120.0	178.0	15.50
A77716.0	–	16.00	0.6299	120.0	178.0	16.00



A160



HSS Jobber Drill, Steam Tempered Finish, with Brazed Carbide Point

HSS body with a brazed carbide tip, giving the performance of a carbide drill with a strong and flexible body. It has a 118°, 4-facet self-centering point making it an economical choice when drilling cast iron materials. It can be used in both conventional and CNC machines.

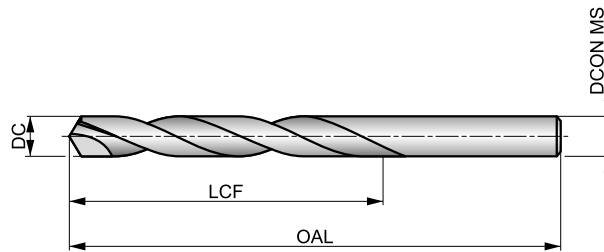

HSS HM	DIN 338	4×D
118°	Bright ST	
λ 20-35°	R	DC h8

Workpiece material group suitability, starting values for cutting speed (m/min) and feed Alpha Code. Tables with feed per revolution can be found starting from page 175.

P1.1 ▣73 E	P1.2 ▣82 E	P1.3 ▣85 E	P2.1 ▣63 E	P2.2 ▣55 D	P2.3 ▣49 C	P3.1 ▣59 D	P3.2 ▣47 D	P3.3 ▣40 C	P4.1 ▣35 D	P4.2 ▣30 C	P4.3 ▣24 A	M1.1 ▣55 B	M1.2 ▣46 B
M2.1 ▣49 B	M2.2 ▣40 B	M3.1 ▣41 C	M3.2 ▣35 C	M3.3 ▣32 C	M4.1 ▣35 A	K1.1 ▣50 C	K1.2 ▣37 A	K1.3 ▣28 A	K2.1 ▣43 A	K2.2 ▣35 A	K2.3 ▣28 A	K3.1 ▣38 A	K3.2 ▣29 A
K3.3 ▣24 A	K4.1 ▣35 A	K4.2 ▣27 A	K4.3 ▣20 A	K4.4 ▣17 A	K4.5 ▣14 A	K5.1 ▣40 A	K5.2 ▣30 A	K5.3 ▣23 A	N1.1 ▣50 I	N1.2 ▣38 I	N1.3 ▣25 H	N2.1 ▣62 G	N2.2 ▣55 G
N2.3 ▣40 G	N3.1 ▣119 C	N3.2 ▣70 G	N3.3 ▣35 D	N4.2 ▣60 E	S1.1 ▣35 A	S1.2 ▣35 A	S1.3 ▣25 A	S2.1 ▣33 A	S2.2 ▣28 A	S3.1 ▣25 A	S3.2 ▣20 A	S4.1 ▣20 A	S4.2 ▣16 A

Product	DC		LCF	OAL	DCON MS
	[mm]	[inch]			
A1604.0	4.00	0.1575	43.0	75.0	4.00
A1604.5	4.50	0.1772	47.0	80.0	4.50
A1605.0	5.00	0.1969	52.0	86.0	5.00
A1605.5	5.50	0.2165	57.0	93.0	5.50
A1606.0	6.00	0.2362	57.0	93.0	6.00
A1606.5	6.50	0.2559	63.0	101.0	6.50
A1606.8	6.80	0.2677	69.0	109.0	6.80
A1607.0	7.00	0.2756	69.0	109.0	7.00
A1607.5	7.50	0.2953	69.0	109.0	7.50
A1608.0	8.00	0.3150	75.0	117.0	8.00
A1608.5	8.50	0.3346	75.0	117.0	8.50
A1609.0	9.00	0.3543	81.0	125.0	9.00
A1609.5	9.50	0.3740	81.0	125.0	9.50
A16010.0	10.00	0.3937	87.0	133.0	10.00
A16010.2	10.20	0.4016	87.0	133.0	10.20
A16010.5	10.50	0.4134	87.0	133.0	10.50
A16011.0	11.00	0.4331	94.0	142.0	11.00
A16011.5	11.50	0.4528	94.0	142.0	11.50
A16012.0	12.00	0.4724	101.0	151.0	12.00
A16013.0	13.00	0.5118	101.0	151.0	13.00
A16014.0	14.00	0.5512	108.0	160.0	14.00
A16015.0	15.00	0.5906	114.0	169.0	15.00
A16016.0	16.00	0.6299	120.0	178.0	16.00



A510



ADX HSS Jobber Drill, TiN Coated

High performance drill, able to produce high quality and accurate holes at high speeds and feeds (H9 hole tolerance). A 130° thinned point aids self-centering. This drill should be used in machines with constant feed only. TiN coating improves performance and extends the tool life. Suitable for drilling many materials.



ADX

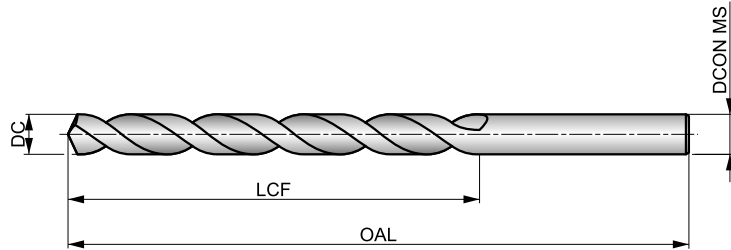

HSS	DIN 338	4×D
130°	TiN	
λ 32-40°	R	DC h8

Workpiece material group suitability, starting values for cutting speed (m/min) and feed Alpha Code. Tables with feed per revolution can be found starting from page 175.

P1.1 ■ 53 M	P1.2 ■ 59 M	P1.3 ■ 61 M	P2.1 ■ 45 M	P2.2 ■ 40 K	P2.3 ■ 35 F	P3.1 ■ 31 H	P3.2 ■ 25 H	P3.3 ■ 21 F	P4.1 ■ 19 H	P4.2 ■ 16 F	P4.3 ▣ 13 D	M1.1 ■ 38 G	M1.2 ■ 32 G
M2.1 ■ 34 G	M2.2 ■ 28 G	M3.1 ■ 16 I	M3.2 ■ 14 I	M3.3 ▣ 13 I	M4.1 ▣ 19 G	K1.1 ■ 42 K	K1.2 ■ 31 J	K1.3 ■ 23 J	K2.1 ■ 34 J	K2.2 ■ 28 J	K2.3 ■ 22 F	K3.1 ■ 30 J	K3.2 ■ 23 J
K3.3 ■ 19 F	K4.1 ■ 28 J	K4.2 ■ 21 J	K4.3 ■ 16 F	K4.4 ■ 13 F	K4.5 ■ 11 F	K5.1 ■ 32 J	K5.2 ■ 24 J	K5.3 ■ 19 F	N1.1 ▣ 50 G	N1.2 ▣ 38 G	N1.3 ■ 25 M	N2.1 ■ 48 I	N2.2 ■ 43 I
N2.3 ■ 31 I	N3.1 ■ 85 I	N3.2 ■ 50 I	N3.3 ▣ 25 D	N4.1 ■ 65 G	N4.2 ■ 50 G	N4.3 ■ 35 F	S1.1 ▣ 32 G	S1.2 ▣ 20 H	S1.3 ▣ 4 B	S2.1 ▣ 12 E	S2.2 ▣ 8 E	S3.1 ▣ 9 E	S3.2 ▣ 6 E
S4.1 ▣ 17 E	S4.2 ▣ 15 E												

Product	DC [inch]	DC [mm]	DC [inch]	LCF [mm]	OAL [mm]	DCON MS [mm]	Product	DC [inch]	DC [mm]	DC [inch]	LCF [mm]	OAL [mm]	DCON MS [mm]
A5103.0	–	3.00	0.1181	33.0	61.0	3.00	A5104.9	–	4.90	0.1929	52.0	86.0	4.90
A5103.1	–	3.10	0.1220	36.0	65.0	3.10	A5105.0	–	5.00	0.1969	52.0	86.0	5.00
A5101/8	1/8	3.18	0.1250	36.0	65.0	3.18	A5105.1	–	5.10	0.2008	52.0	86.0	5.10
A5103.2	–	3.20	0.1260	36.0	65.0	3.20	A51013/64	13/64	5.16	0.2031	52.0	86.0	5.16
A5103.3	–	3.30	0.1299	36.0	65.0	3.30	A5105.2	–	5.20	0.2047	52.0	86.0	5.20
A5103.4	–	3.40	0.1339	39.0	70.0	3.40	A5105.3	–	5.30	0.2087	52.0	86.0	5.30
A5103.5	–	3.50	0.1378	39.0	70.0	3.50	A5105.4	–	5.40	0.2126	57.0	93.0	5.40
A5109/64	9/64	3.57	0.1406	39.0	70.0	3.57	A5105.5	–	5.50	0.2165	57.0	93.0	5.50
A5103.6	–	3.60	0.1417	39.0	70.0	3.60	A5107/32	7/32	5.56	0.2188	57.0	93.0	5.56
A5103.7	–	3.70	0.1457	39.0	70.0	3.70	A5105.6	–	5.60	0.2205	57.0	93.0	5.60
A5103.8	–	3.80	0.1496	43.0	75.0	3.80	A5105.7	–	5.70	0.2244	57.0	93.0	5.70
A5103.9	–	3.90	0.1535	43.0	75.0	3.90	A5105.8	–	5.80	0.2283	57.0	93.0	5.80
A5105/32	5/32	3.97	0.1563	43.0	75.0	3.97	A5105.9	–	5.90	0.2323	57.0	93.0	5.90
A5104.0	–	4.00	0.1575	43.0	75.0	4.00	A51015/64	15/64	5.95	0.2344	57.0	93.0	5.95
A5104.1	–	4.10	0.1614	43.0	75.0	4.10	A5106.0	–	6.00	0.2362	57.0	93.0	6.00
A5104.2	–	4.20	0.1654	43.0	75.0	4.20	A5106.1	–	6.10	0.2402	63.0	101.0	6.10
A5104.3	–	4.30	0.1693	47.0	80.0	4.30	A5106.2	–	6.20	0.2441	63.0	101.0	6.20
A51011/64	11/64	4.37	0.1719	47.0	80.0	4.37	A5106.3	–	6.30	0.2480	63.0	101.0	6.30
A5104.4	–	4.40	0.1732	47.0	80.0	4.40	A5101/4	1/4	6.35	0.2500	63.0	101.0	6.35
A5104.5	–	4.50	0.1772	47.0	80.0	4.50	A5106.4	–	6.40	0.2520	63.0	101.0	6.40
A5104.6	–	4.60	0.1811	47.0	80.0	4.60	A5106.5	–	6.50	0.2559	63.0	101.0	6.50
A5104.7	–	4.70	0.1850	47.0	80.0	4.70	A5106.6	–	6.60	0.2598	63.0	101.0	6.60
A5103/16	3/16	4.76	0.1875	52.0	86.0	4.76	A5106.7	–	6.70	0.2638	63.0	101.0	6.70
A5104.8	–	4.80	0.1890	52.0	86.0	4.80	A51017/64	17/64	6.75	0.2656	69.0	109.0	6.75



Product	DC	DC	DC	LCF	OAL	D CON MS
	[inch]	[mm]	[inch]	[mm]	[mm]	[mm]
A5106.8	—	6.80	0.2677	69.0	109.0	6.80
A5106.9	—	6.90	0.2717	69.0	109.0	6.90
A5107.0	—	7.00	0.2756	69.0	109.0	7.00
A5107.1	—	7.10	0.2795	69.0	109.0	7.10
A5109/32	9/32	7.14	0.2813	69.0	109.0	7.14
A5107.2	—	7.20	0.2835	69.0	109.0	7.20
A5107.3	—	7.30	0.2874	69.0	109.0	7.30
A5107.4	—	7.40	0.2913	69.0	109.0	7.40
A5107.5	—	7.50	0.2953	69.0	109.0	7.50
A51019/64	19/64	7.54	0.2969	75.0	117.0	7.54
A5107.6	—	7.60	0.2992	75.0	117.0	7.60
A5107.7	—	7.70	0.3031	75.0	117.0	7.70
A5107.8	—	7.80	0.3071	75.0	117.0	7.80
A5107.9	—	7.90	0.3110	75.0	117.0	7.90
A5105/16	5/16	7.94	0.3125	75.0	117.0	7.94
A5108.0	—	8.00	0.3150	75.0	117.0	8.00
A5108.1	—	8.10	0.3189	75.0	117.0	8.10
A5108.2	—	8.20	0.3228	75.0	117.0	8.20
A5108.3	—	8.30	0.3268	75.0	117.0	8.30
A51021/64	21/64	8.33	0.3281	75.0	117.0	8.33
A5108.4	—	8.40	0.3307	75.0	117.0	8.40
A5108.5	—	8.50	0.3346	75.0	117.0	8.50
A5108.6	—	8.60	0.3386	81.0	125.0	8.60
A5108.7	—	8.70	0.3425	81.0	125.0	8.70
A51011/32	11/32	8.73	0.3438	81.0	125.0	8.73
A5108.8	—	8.80	0.3465	81.0	125.0	8.80
A5108.9	—	8.90	0.3504	81.0	125.0	8.90
A5109.0	—	9.00	0.3543	81.0	125.0	9.00
A5109.1	—	9.10	0.3583	81.0	125.0	9.10
A51023/64	23/64	9.13	0.3594	81.0	125.0	9.13
A5109.2	—	9.20	0.3622	81.0	125.0	9.20
A5109.3	—	9.30	0.3661	81.0	125.0	9.30
A5109.4	—	9.40	0.3701	81.0	125.0	9.40
A5109.5	—	9.50	0.3740	81.0	125.0	9.50
A5103/8	3/8	9.52	0.3750	87.0	133.0	9.52
A5109.6	—	9.60	0.3780	87.0	133.0	9.60
A5109.7	—	9.70	0.3819	87.0	133.0	9.70
A5109.8	—	9.80	0.3858	87.0	133.0	9.80
A5109.9	—	9.90	0.3898	87.0	133.0	9.90
A51025/64	25/64	9.92	0.3906	87.0	133.0	9.92

Product	DC	DC	DC	LCF	OAL	D CON MS
	[inch]	[mm]	[inch]	[mm]	[mm]	[mm]
A51010.0	—	10.00	0.3937	87.0	133.0	10.00
A51010.1	—	10.10	0.3976	87.0	133.0	10.10
A51010.2	—	10.20	0.4016	87.0	133.0	10.20
A51010.3	—	10.30	0.4055	87.0	133.0	10.30
A51013/32	13/32	10.32	0.4063	87.0	133.0	10.32
A51010.4	—	10.40	0.4094	87.0	133.0	10.40
A51010.5	—	10.50	0.4134	87.0	133.0	10.50
A51010.6	—	10.60	0.4173	87.0	133.0	10.60
A51010.7	—	10.70	0.4213	94.0	142.0	10.70
A51027/64	27/64	10.72	0.4219	94.0	142.0	10.72
A51010.8	—	10.80	0.4252	94.0	142.0	10.80
A51010.9	—	10.90	0.4291	94.0	142.0	10.90
A51011.0	—	11.00	0.4331	94.0	142.0	11.00
A51011.1	—	11.10	0.4370	94.0	142.0	11.10
A5107/16	7/16	11.11	0.4375	94.0	142.0	11.11
A51011.2	—	11.20	0.4409	94.0	142.0	11.20
A51011.3	—	11.30	0.4449	94.0	142.0	11.30
A51011.4	—	11.40	0.4488	94.0	142.0	11.40
A51011.5	—	11.50	0.4528	94.0	142.0	11.50
A51029/64	29/64	11.51	0.4531	94.0	142.0	11.51
A51011.6	—	11.60	0.4567	94.0	142.0	11.60
A51011.7	—	11.70	0.4606	94.0	142.0	11.70
A51011.8	—	11.80	0.4646	94.0	142.0	11.80
A51011.9	—	11.90	0.4685	101.0	151.0	11.90
A51015/32	15/32	11.91	0.4688	101.0	151.0	11.91
A51012.0	—	12.00	0.4724	101.0	151.0	12.00
A51012.1	—	12.10	0.4764	101.0	151.0	12.10
A51012.2	—	12.20	0.4803	101.0	151.0	12.20
A51012.3	—	12.30	0.4843	101.0	151.0	12.30
A51031/64	31/64	12.30	0.4844	101.0	151.0	12.30
A51012.4	—	12.40	0.4882	101.0	151.0	12.40
A51012.5	—	12.50	0.4921	101.0	151.0	12.50
A51012.6	—	12.60	0.4961	101.0	151.0	12.60
A51012.7	—	12.70	0.5000	101.0	151.0	12.70
A5101/2	1/2	12.70	0.5000	101.0	151.0	12.70
A51012.8	—	12.80	0.5039	101.0	151.0	12.80
A51012.9	—	12.90	0.5079	101.0	151.0	12.90
A51013.0	—	13.00	0.5118	101.0	151.0	13.00
A51014.0	—	14.00	0.5512	108.0	160.0	14.00



A553



ADX HSS-E (5% Cobalt) Jobber Drill, TiAlN Top Coated with Coolant Feed

High performance drill, able to produce high quality, accurate holes at high speeds and feeds (H9 hole tolerance). A 130° thinned point and TiAlN Top coating improves performance and extends the tool life. This drill should be used in CNC machines only. Suitable for drilling many materials.



ADX

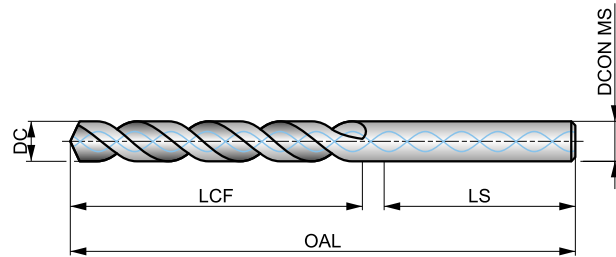

HSS-E	DORMER	5xD
130°	TiAlN Top	DIN 6535HA
$\lambda > 35^\circ$	R	DCON MS
DC h8		

Workpiece material group suitability, starting values for cutting speed (m/min) and feed Alpha Code. Tables with feed per revolution can be found starting from page 175.

P1.1 ■ 80 L	P1.2 ■ 89 L	P1.3 ■ 92 L	P2.1 ■ 68 L	P2.2 ■ 60 L	P2.3 ■ 53 F	P3.1 ■ 41 H	P3.2 ■ 33 H	P3.3 ■ 28 F	P4.1 ■ 25 H	P4.2 ■ 21 F	P4.3 ■ 17 D	M1.1 ■ 55 G	M1.2 ■ 46 G
M2.1 ■ 49 G	M2.2 ■ 40 G	M3.1 ■ 22 I	M3.2 ■ 19 I	M3.3 ■ 17 I	M4.1 ■ 27 G	K1.1 ■ 70 K	K1.2 ■ 52 J	K1.3 ■ 39 J	K2.1 ■ 55 J	K2.2 ■ 45 J	K2.3 ■ 36 F	K3.1 ■ 49 J	K3.2 ■ 37 J
K3.3 ■ 30 F	K4.1 ■ 45 J	K4.2 ■ 34 J	K4.3 ■ 25 F	K4.4 ■ 22 F	K4.5 ■ 18 F	K5.1 ■ 51 J	K5.2 ■ 39 J	K5.3 ■ 30 F	N1.1 ■ 70 H	N1.2 ■ 53 H	N1.3 ■ 35 M	N2.1 ■ 85 I	N2.2 ■ 76 I
N2.3 ■ 55 I	N3.1 ■ 144 I	N3.2 ■ 85 I	N3.3 ■ 43 G	N4.1 ■ 90 G	S1.1 ■ 45 G	S1.2 ■ 30 E	S1.3 ■ 8 C	S2.1 ■ 20 E	S2.2 ■ 14 G	S3.1 ■ 15 E	S3.2 ■ 10 G	S4.1 ■ 12 E	S4.2 ■ 8 G

DCON MS tolerance h6.

Product	DC		LCF	OAL	LS	DCON MS	Product	DC		LCF	OAL	LS	DCON MS
	[mm]	[inch]						[mm]	[inch]				
A5535.0	5.00	0.1969	36.0	79.0	36.0	6.00	A55311.3	11.30	0.4449	94.0	150.0	45.0	12.00
A5535.2	5.20	0.2047	38.0	79.0	36.0	6.00	A55311.5	11.50	0.4528	94.0	150.0	45.0	12.00
A5535.5	5.50	0.2165	40.0	79.0	36.0	6.00	A55312.0	12.00	0.4724	94.0	150.0	45.0	12.00
A5536.0	6.00	0.2362	43.0	79.0	36.0	6.00	A55312.5	12.50	0.4921	101.0	160.0	45.0	14.00
A5536.3	6.30	0.2480	46.0	87.0	36.0	8.00	A55313.0	13.00	0.5118	101.0	160.0	45.0	14.00
A5536.5	6.50	0.2559	47.0	87.0	36.0	8.00	A55313.5	13.50	0.5315	101.0	160.0	45.0	14.00
A5536.8	6.80	0.2677	48.0	87.0	36.0	8.00	A55314.0	14.00	0.5512	101.0	160.0	45.0	14.00
A5536.9	6.90	0.2717	48.0	87.0	36.0	8.00	A55314.25	14.25	0.5610	108.0	170.0	48.0	16.00
A5537.0	7.00	0.2756	48.0	87.0	36.0	8.00	A55314.5	14.50	0.5709	108.0	170.0	48.0	16.00
A5537.4	7.40	0.2913	54.0	94.0	36.0	8.00	A55315.0	15.00	0.5906	108.0	170.0	48.0	16.00
A5537.5	7.50	0.2953	54.0	94.0	36.0	8.00	A55315.25	15.25	0.6004	108.0	170.0	48.0	16.00
A5538.0	8.00	0.3150	58.0	94.0	36.0	8.00	A55315.5	15.50	0.6102	108.0	170.0	48.0	16.00
A5538.5	8.50	0.3346	75.0	130.0	40.0	10.00	A55316.0	16.00	0.6299	108.0	170.0	48.0	16.00
A5538.7	8.70	0.3425	75.0	130.0	40.0	10.00	A55316.5	16.50	0.6496	125.0	190.0	48.0	18.00
A5539.0	9.00	0.3543	75.0	130.0	40.0	10.00	A55317.0	17.00	0.6693	125.0	190.0	48.0	18.00
A5539.5	9.50	0.3740	75.0	130.0	40.0	10.00	A55317.5	17.50	0.6890	130.0	190.0	48.0	18.00
A55310.0	10.00	0.3937	75.0	130.0	40.0	10.00	A55317.75	17.75	0.6988	130.0	190.0	48.0	18.00
A55310.2	10.20	0.4016	87.0	150.0	45.0	12.00	A55318.0	18.00	0.7087	130.0	190.0	48.0	18.00
A55310.3	10.30	0.4055	87.0	150.0	45.0	12.00	A55319.0	19.00	0.7480	135.0	200.0	50.0	20.00
A55310.5	10.50	0.4134	87.0	150.0	45.0	12.00	A55319.25	19.25	0.7579	140.0	200.0	50.0	20.00
A55311.0	11.00	0.4331	94.0	150.0	45.0	12.00	A55320.0	20.00	0.7874	140.0	200.0	50.0	20.00



A900



PFX HSS-E (5% Cobalt) Jobber Drill, Bright Finish

High performance drill, able to produce high quality and accurate holes at high speeds and feeds (H10 hole tolerance). Self-centering 130° point angle and special parabolic flute design help to drill deep holes in a single pass. Suitable for many materials.



PFX

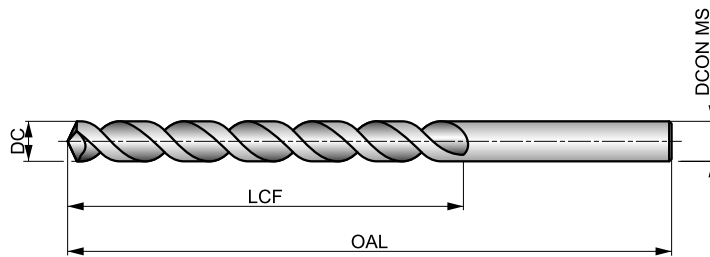

HSS-E	DIN ANSI	6×D
130°	Bright	
λ>35°	R	DC h8

Workpiece material group suitability, starting values for cutting speed (m/min) and feed Alpha Code. Tables with feed per revolution can be found starting from page 175.

P1.1 ■ 34 H	P1.2 ■ 39 H	P1.3 ■ 40 H	P2.1 ■ 30 H	P2.2 ■ 26 H	P2.3 ■ 23 E	P3.1 ■ 31 H	P3.2 ■ 25 H	P3.3 ■ 21 E	P4.1 ■ 19 H	P4.2 ■ 16 E	P4.3 ■ 13 E	M1.1 ■ 21 E	M1.2 ■ 17 E
M2.1 ■ 18 E	M2.2 ■ 15 E	M3.1 ■ 8 E	M3.2 ■ 7 E	M3.3 ■ 6 E	M4.1 ■ 9 C	K1.1 ■ 24 J	K1.2 ■ 18 J	K1.3 ■ 13 J	K2.1 ■ 23 J	K2.2 ■ 19 J	K2.3 ■ 15 I	K3.1 ■ 21 J	K3.2 ■ 16 J
K3.3 ■ 13 I	K4.1 ■ 19 J	K4.2 ■ 14 J	K4.3 ■ 11 I	K4.4 ■ 9 I	K4.5 ■ 8 I	K5.1 ■ 22 J	K5.2 ■ 16 J	K5.3 ■ 13 I	N1.1 ■ 60 J	N1.2 ■ 45 J	N1.3 ■ 30 N	N2.1 ■ 62 N	N2.2 ■ 55 N
N2.3 ■ 40 N	N3.1 ■ 90 H	N3.2 ■ 53 I	N3.3 ■ 27 G	N4.1 ■ 55 I	N4.2 ■ 40 G	S1.1 ■ 22 E	S1.2 ■ 15 E	S1.3 ■ 6 C	S2.1 ■ 9 G	S2.2 ■ 8 C	S3.1 ■ 7 G	S3.2 ■ 6 C	S4.1 ■ 5 G
S4.2 ■ 5 C													

Product	DC [inch]	DC [mm]	DC [inch]	LCF [mm]	OAL [mm]	DCON MS [mm]
A9001.0	–	1.00	0.0394	12.0	34.0	1.00
A9001.1	–	1.10	0.0433	14.0	36.0	1.10
A9003/64	3/64	1.19	0.0469	19.0	44.0	1.19
A9001.2	–	1.20	0.0472	16.0	38.0	1.20
A9001.25	–	1.25	0.0492	16.0	36.0	1.25
A9001.3	–	1.30	0.0512	16.0	38.0	1.30
A9001.4	–	1.40	0.0551	18.0	40.0	1.40
A9001.5	–	1.50	0.0591	18.0	40.0	1.50
A9001.55	–	1.55	0.0610	20.0	43.0	1.55
A9001/16	1/16	1.59	0.0625	22.0	48.0	1.59
A9001.6	–	1.60	0.0630	20.0	43.0	1.60
A9001.7	–	1.70	0.0669	20.0	43.0	1.70
A9001.75	–	1.75	0.0689	22.0	46.0	1.75
A9001.8	–	1.80	0.0709	22.0	46.0	1.80
A9001.9	–	1.90	0.0748	22.0	46.0	1.90
A9005/64	5/64	1.98	0.0781	25.0	51.0	1.98
A9002.0	–	2.00	0.0787	24.0	49.0	2.00
A9002.1	–	2.10	0.0827	24.0	49.0	2.10
A9002.15	–	2.15	0.0846	27.0	53.0	2.15
A9002.2	–	2.20	0.0866	27.0	53.0	2.20
A9002.3	–	2.30	0.0906	27.0	53.0	2.30
A9003/32	3/32	2.38	0.0937	32.0	57.0	2.38
A9002.4	–	2.40	0.0945	30.0	57.0	2.40
A9002.5	–	2.50	0.0984	30.0	57.0	2.50

Product	DC [inch]	DC [mm]	DC [inch]	LCF [mm]	OAL [mm]	DCON MS [mm]
A9002.6	–	2.60	0.1024	30.0	57.0	2.60
A9002.7	–	2.70	0.1063	33.0	61.0	2.70
A9007/64	7/64	2.78	0.1094	38.0	67.0	2.78
A9002.8	–	2.80	0.1102	33.0	61.0	2.80
A9002.9	–	2.90	0.1142	33.0	61.0	2.90
A9003.0	–	3.00	0.1181	33.0	61.0	3.00
A9003.1	–	3.10	0.1220	36.0	65.0	3.10
A9001/8	1/8	3.18	0.1250	41.0	70.0	3.18
A9003.2	–	3.20	0.1260	36.0	65.0	3.20
A9003.3	–	3.30	0.1299	36.0	65.0	3.30
A9003.4	–	3.40	0.1339	39.0	70.0	3.40
A9003.5	–	3.50	0.1378	39.0	70.0	3.50
A9009/64	9/64	3.57	0.1406	44.0	73.0	3.57
A9003.6	–	3.60	0.1417	39.0	70.0	3.60
A9003.7	–	3.70	0.1457	39.0	70.0	3.70
A9003.8	–	3.80	0.1496	43.0	75.0	3.80
A9003.9	–	3.90	0.1535	43.0	75.0	3.90
A9005/32	5/32	3.97	0.1563	51.0	79.0	3.97
A9004.0	–	4.00	0.1575	43.0	75.0	4.00
A9004.1	–	4.10	0.1614	43.0	75.0	4.10
A9004.2	–	4.20	0.1654	43.0	75.0	4.20
A9004.3	–	4.30	0.1693	47.0	80.0	4.30
A90011/64	11/64	4.37	0.1719	54.0	83.0	4.37
A9004.4	–	4.40	0.1732	47.0	80.0	4.40



Product	DC	DC	DC	LCF	OAL	D CON MS
	[inch]	[mm]	[inch]	[mm]	[mm]	[mm]
A9004.5	–	4.50	0.1772	47.0	80.0	4.50
A9004.6	–	4.60	0.1811	47.0	80.0	4.60
A9004.7	–	4.70	0.1850	47.0	80.0	4.70
A9003/16	3/16	4.76	0.1875	59.0	89.0	4.76
A9004.8	–	4.80	0.1890	52.0	86.0	4.80
A9004.9	–	4.90	0.1929	52.0	86.0	4.90
A9005.0	–	5.00	0.1969	52.0	86.0	5.00
A9005.1	–	5.10	0.2008	52.0	86.0	5.10
A90013/64	13/64	5.16	0.2031	62.0	92.0	5.16
A9005.2	–	5.20	0.2047	52.0	86.0	5.20
A9005.3	–	5.30	0.2087	52.0	86.0	5.30
A9005.4	–	5.40	0.2126	57.0	93.0	5.40
A9005.5	–	5.50	0.2165	57.0	93.0	5.50
A9007/32	7/32	5.56	0.2188	64.0	95.0	5.56
A9005.6	–	5.60	0.2205	57.0	93.0	5.60
A9005.7	–	5.70	0.2244	57.0	93.0	5.70
A9005.8	–	5.80	0.2283	57.0	93.0	5.80
A9005.9	–	5.90	0.2323	57.0	93.0	5.90
A90015/64	15/64	5.95	0.2344	67.0	98.0	5.95
A9006.0	–	6.00	0.2362	57.0	93.0	6.00
A9006.1	–	6.10	0.2402	63.0	101.0	6.10
A9006.2	–	6.20	0.2441	63.0	101.0	6.20
A9006.3	–	6.30	0.2480	63.0	101.0	6.30
A9001/4	1/4	6.35	0.2500	70.0	102.0	6.35
A9006.4	–	6.40	0.2520	63.0	101.0	6.40
A9006.5	–	6.50	0.2559	63.0	101.0	6.50
A9006.6	–	6.60	0.2598	63.0	101.0	6.60
A9006.7	–	6.70	0.2638	63.0	101.0	6.70
A90017/64	17/64	6.75	0.2656	73.0	105.0	6.75
A9006.8	–	6.80	0.2677	69.0	109.0	6.80
A9006.9	–	6.90	0.2717	69.0	109.0	6.90
A9007.0	–	7.00	0.2756	69.0	109.0	7.00
A9007.1	–	7.10	0.2795	69.0	109.0	7.10
A9009/32	9/32	7.14	0.2813	75.0	108.0	7.14
A9007.2	–	7.20	0.2835	69.0	109.0	7.20
A9007.3	–	7.30	0.2874	69.0	109.0	7.30
A9007.4	–	7.40	0.2913	69.0	109.0	7.40
A9007.5	–	7.50	0.2953	69.0	109.0	7.50
A90019/64	19/64	7.54	0.2969	78.0	111.0	7.54
A9007.6	–	7.60	0.2992	75.0	117.0	7.60
A9007.7	–	7.70	0.3031	75.0	117.0	7.70
A9007.8	–	7.80	0.3071	75.0	117.0	7.80
A9007.9	–	7.90	0.3110	75.0	117.0	7.90
A9005/16	5/16	7.94	0.3125	81.0	114.0	7.94
A9008.0	–	8.00	0.3150	75.0	117.0	8.00
A9008.1	–	8.10	0.3189	75.0	117.0	8.10
A9008.2	–	8.20	0.3228	75.0	117.0	8.20
A9008.3	–	8.30	0.3268	75.0	117.0	8.30
A90021/64	21/64	8.33	0.3281	84.0	117.0	8.33
A9008.4	–	8.40	0.3307	75.0	117.0	8.40
A9008.5	–	8.50	0.3346	75.0	117.0	8.50
A9008.6	–	8.60	0.3386	81.0	125.0	8.60
A9008.7	–	8.70	0.3425	81.0	125.0	8.70
A90011/32	11/32	8.73	0.3438	87.0	121.0	8.73
A9008.8	–	8.80	0.3465	81.0	125.0	8.80
A9008.9	–	8.90	0.3504	81.0	125.0	8.90
A9009.0	–	9.00	0.3543	81.0	125.0	9.00
A9009.1	–	9.10	0.3583	81.0	125.0	9.10
A90023/64	23/64	9.13	0.3594	89.0	124.0	9.13
A9009.2	–	9.20	0.3622	81.0	125.0	9.20

Product	DC	DC	DC	LCF	OAL	D CON MS
	[inch]	[mm]	[inch]	[mm]	[mm]	[mm]
A9009.3	–	9.30	0.3661	81.0	125.0	9.30
A9009.4	–	9.40	0.3701	81.0	125.0	9.40
A9009.5	–	9.50	0.3740	81.0	125.0	9.50
A9003/8	3/8	9.52	0.3750	92.0	127.0	9.52
A9009.6	–	9.60	0.3780	87.0	133.0	9.60
A9009.7	–	9.70	0.3819	87.0	133.0	9.70
A9009.8	–	9.80	0.3858	87.0	133.0	9.80
A9009.9	–	9.90	0.3898	87.0	133.0	9.90
A90025/64	25/64	9.92	0.3906	95.0	130.0	9.92
A90010.0	–	10.00	0.3937	87.0	133.0	10.00
A90010.2	–	10.20	0.4016	87.0	133.0	10.20
A90010.3	–	10.30	0.4055	87.0	133.0	10.30
A90013/32	13/32	10.32	0.4063	98.0	133.0	10.32
A90010.4	–	10.40	0.4094	87.0	133.0	10.40
A90010.5	–	10.50	0.4134	87.0	133.0	10.50
A90027/64	27/64	10.72	0.4219	100.0	137.0	10.72
A90010.8	–	10.80	0.4252	94.0	142.0	10.80
A90011.0	–	11.00	0.4331	94.0	142.0	11.00
A9007/16	7/16	11.11	0.4375	103.0	140.0	11.11
A90011.5	–	11.50	0.4528	94.0	142.0	11.50
A90029/64	29/64	11.51	0.4531	106.0	143.0	11.51
A90011.8	–	11.80	0.4646	94.0	142.0	11.80
A90015/32	15/32	11.91	0.4688	110.0	146.0	11.91
A90012.0	–	12.00	0.4724	101.0	151.0	12.00
A90031/64	31/64	12.30	0.4844	111.0	149.0	12.30
A90012.5	–	12.50	0.4921	101.0	151.0	12.50
A9001/2	1/2	12.70	0.5000	101.0	151.0	12.70
A90013.0	–	13.00	0.5118	101.0	151.0	13.00
A90033/64	33/64	13.10	0.5156	122.0	168.0	13.10
A90013.5	–	13.50	0.5315	108.0	160.0	13.50
A90035/64	35/64	13.89	0.5469	122.0	168.0	13.89
A90014.0	–	14.00	0.5512	108.0	160.0	14.00
A9009/16	9/16	14.29	0.5625	122.0	168.0	14.29
A90014.5	–	14.50	0.5709	114.0	169.0	14.50
A90037/64	37/64	14.68	0.5781	122.0	168.0	14.68
A90015.0	–	15.00	0.5906	114.0	169.0	15.00
A90019/32	19/32	15.08	0.5938	132.0	181.0	15.08
A90039/64	39/64	15.48	0.6094	132.0	181.0	15.48
A90015.5	–	15.50	0.6102	120.0	178.0	15.50
A9005/8	5/8	15.88	0.6250	132.0	181.0	15.88
A90016.0	–	16.00	0.6299	120.0	178.0	16.00
A90041/64	41/64	16.27	0.6406	132.0	181.0	16.27
A90016.5	–	16.50	0.6496	125.0	184.0	16.50
A90021/32	21/32	16.67	0.6563	132.0	181.0	16.67
A90017.0	–	17.00	0.6693	125.0	184.0	17.00
A90043/64	43/64	17.07	0.6719	143.0	194.0	17.07
A90011/16	11/16	17.46	0.6875	143.0	194.0	17.46
A90017.5	–	17.50	0.6890	130.0	191.0	17.50
A90045/64	45/64	17.86	0.7031	130.0	191.0	17.86
A90018.0	–	18.00	0.7087	130.0	191.0	18.00
A90023/32	23/32	18.26	0.7188	130.0	191.0	18.26
A90018.5	–	18.50	0.7283	135.0	198.0	18.50
A90047/64	47/64	18.65	0.7344	135.0	198.0	18.65
A90019.0	–	19.00	0.7480	135.0	198.0	19.00
A9003/4	3/4	19.05	0.7500	135.0	198.0	19.05
A90049/64	49/64	19.45	0.7656	135.0	198.0	19.45
A90019.5	–	19.50	0.7677	140.0	205.0	19.50
A90025/32	25/32	19.84	0.7813	140.0	205.0	19.84
A90020.0	–	20.00	0.7874	140.0	205.0	20.00



A901



PFX HSS-E (5% Cobalt) Jobbler Drill, Alcrona Top Coated

High performance drill, able to produce high quality and accurate holes at high speeds and feeds (H10 hole tolerance). A 130° point angle and special parabolic flute design. Suitable for many materials. Alcrona-TOP coating improves performance and extends the tool life.



PFX

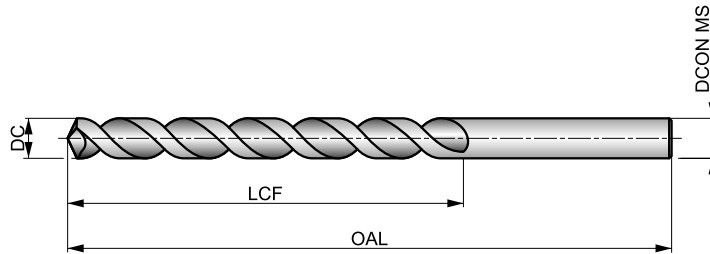

HSS-E	DIN ANSI	6xD
130°	Alcrona Top	
$\lambda > 35^\circ$	R	DC h8

Workpiece material group suitability, starting values for cutting speed (m/min) and feed Alpha Code. Tables with feed per revolution can be found starting from page 175.

P1.1 ■ 58 J	P1.2 ■ 65 J	P1.3 ■ 68 J	P2.1 ■ 50 J	P2.2 ■ 44 I	P2.3 ■ 39 G	P3.1 ■ 49 I	P3.2 ■ 39 I	P3.3 ■ 33 G	P4.1 ■ 29 I	P4.2 ■ 25 G	P4.3 ■ 20 G	M1.1 ■ 23 E	M1.2 ■ 20 E
M2.1 ■ 21 E	M2.2 ■ 17 E	M3.1 ■ 10 E	M3.2 ■ 9 E	M3.3 ■ 8 E	M4.1 ■ 11 C	K1.1 ■ 58 I	K1.2 ■ 43 I	K1.3 ■ 32 I	K2.1 ■ 42 J	K2.2 ■ 34 J	K2.3 ■ 27 I	K3.1 ■ 37 J	K3.2 ■ 28 J
K3.3 ■ 23 I	K4.1 ■ 34 J	K4.2 ■ 26 J	K4.3 ■ 19 I	K4.4 ■ 16 I	K4.5 ■ 14 I	K5.1 ■ 39 J	K5.2 ■ 29 J	K5.3 ■ 23 I	S1.1 ■ 35 G	S1.2 ■ 24 G	S1.3 ■ 10 E	S2.1 ■ 15 I	S2.2 ■ 14 E
S3.1 ■ 11 I	S3.2 ■ 10 E	S4.1 ■ 9 I	S4.2 ■ 8 E										

Product	DC	DC	DC	LCF	OAL	DCON MS
	[inch]	[mm]	[inch]	[mm]	[mm]	[mm]
A9011.5	–	1.50	0.0591	18.0	40.0	1.50
A9011.55	–	1.55	0.0610	20.0	43.0	1.55
A9011/16	1/16	1.59	0.0625	22.0	48.0	1.59
A9011.6	–	1.60	0.0630	20.0	43.0	1.60
A9011.75	–	1.75	0.0689	22.0	46.0	1.75
A9011.8	–	1.80	0.0709	22.0	46.0	1.80
A9011.9	–	1.90	0.0748	22.0	46.0	1.90
A9015/64	5/64	1.98	0.0781	25.0	51.0	1.98
A9012.0	–	2.00	0.0787	24.0	49.0	2.00
A9012.1	–	2.10	0.0827	24.0	49.0	2.10
A9012.15	–	2.15	0.0846	27.0	53.0	2.15
A9013/32	3/32	2.38	0.0937	32.0	57.0	2.38
A9012.4	–	2.40	0.0945	30.0	57.0	2.40
A9012.5	–	2.50	0.0984	30.0	57.0	2.50
A9012.6	–	2.60	0.1024	30.0	57.0	2.60
A9012.7	–	2.70	0.1063	33.0	61.0	2.70
A9017/64	7/64	2.78	0.1094	38.0	67.0	2.78
A9012.9	–	2.90	0.1142	33.0	61.0	2.90
A9013.0	–	3.00	0.1181	33.0	61.0	3.00
A9013.1	–	3.10	0.1220	36.0	65.0	3.10
A9011/8	1/8	3.18	0.1250	41.0	70.0	3.18
A9013.2	–	3.20	0.1260	36.0	65.0	3.20
A9013.3	–	3.30	0.1299	36.0	65.0	3.30
A9013.4	–	3.40	0.1339	39.0	70.0	3.40
A9013.5	–	3.50	0.1378	39.0	70.0	3.50
A9013.6	–	3.60	0.1417	39.0	70.0	3.60

Product	DC	DC	DC	LCF	OAL	DCON MS
	[inch]	[mm]	[inch]	[mm]	[mm]	[mm]
A9019/64	9/64	3.57	0.1406	44.0	73.0	3.57
A9013.7	–	3.70	0.1457	39.0	70.0	3.70
A9013.8	–	3.80	0.1496	43.0	75.0	3.80
A9013.9	–	3.90	0.1535	43.0	75.0	3.90
A9015/32	5/32	3.97	0.1563	51.0	79.0	3.97
A9014.0	–	4.00	0.1575	43.0	75.0	4.00
A9014.1	–	4.10	0.1614	43.0	75.0	4.10
A9014.2	–	4.20	0.1654	43.0	75.0	4.20
A9014.3	–	4.30	0.1693	47.0	80.0	4.30
A90111/64	11/64	4.37	0.1719	54.0	83.0	4.37
A9014.4	–	4.40	0.1732	47.0	80.0	4.40
A9014.5	–	4.50	0.1772	47.0	80.0	4.50
A9014.6	–	4.60	0.1811	47.0	80.0	4.60
A9014.7	–	4.70	0.1850	47.0	80.0	4.70
A9013/16	3/16	4.76	0.1875	59.0	89.0	4.76
A9014.8	–	4.80	0.1890	52.0	86.0	4.80
A9014.9	–	4.90	0.1929	52.0	86.0	4.90
A9015.0	–	5.00	0.1969	52.0	86.0	5.00
A9015.1	–	5.10	0.2008	52.0	86.0	5.10
A90113/64	13/64	5.16	0.2031	62.0	92.0	5.16
A9015.2	–	5.20	0.2047	52.0	86.0	5.20
A9015.3	–	5.30	0.2087	52.0	86.0	5.30
A9015.4	–	5.40	0.2126	57.0	93.0	5.40
A9015.5	–	5.50	0.2165	57.0	93.0	5.50
A9017/32	7/32	5.56	0.2188	64.0	95.0	5.56
A9015.6	–	5.60	0.2205	57.0	93.0	5.60



Product	DC	DC	DC	LCF	OAL	DCON MS
	[inch]	[mm]	[inch]	[mm]	[mm]	[mm]
A9015.7	–	5.70	0.2244	57.0	93.0	5.70
A9015.8	–	5.80	0.2283	57.0	93.0	5.80
A9015.9	–	5.90	0.2323	57.0	93.0	5.90
A90115/64	15/64	5.95	0.2344	67.0	98.0	5.95
A9016.0	–	6.00	0.2362	57.0	93.0	6.00
A9016.1	–	6.10	0.2402	63.0	101.0	6.10
A9016.2	–	6.20	0.2441	63.0	101.0	6.20
A9016.3	–	6.30	0.2480	63.0	101.0	6.30
A9011/4	1/4	6.35	0.2500	70.0	102.0	6.35
A9016.4	–	6.40	0.2520	63.0	101.0	6.40
A9016.5	–	6.50	0.2559	63.0	101.0	6.50
A9016.6	–	6.60	0.2598	63.0	101.0	6.60
A9016.7	–	6.70	0.2638	63.0	101.0	6.70
A90117/64	17/64	6.75	0.2656	73.0	105.0	6.75
A9016.8	–	6.80	0.2677	69.0	109.0	6.80
A9016.9	–	6.90	0.2717	69.0	109.0	6.90
A9017.0	–	7.00	0.2756	69.0	109.0	7.00
A9017.1	–	7.10	0.2795	69.0	109.0	7.10
A9019/32	9/32	7.14	0.2813	75.0	108.0	7.14
A9017.2	–	7.20	0.2835	69.0	109.0	7.20
A9017.3	–	7.30	0.2874	69.0	109.0	7.30
A9017.4	–	7.40	0.2913	69.0	109.0	7.40
A9017.5	–	7.50	0.2953	69.0	109.0	7.50
A90119/64	19/64	7.54	0.2969	78.0	111.0	7.54
A9017.6	–	7.60	0.2992	75.0	117.0	7.60
A9017.7	–	7.70	0.3031	75.0	117.0	7.70
A9017.8	–	7.80	0.3071	75.0	117.0	7.80
A9017.9	–	7.90	0.3110	75.0	117.0	7.90
A9015/16	5/16	7.94	0.3125	81.0	114.0	7.94
A9018.0	–	8.00	0.3150	75.0	117.0	8.00
A9018.1	–	8.10	0.3189	75.0	117.0	8.10
A9018.2	–	8.20	0.3228	75.0	117.0	8.20
A9018.3	–	8.30	0.3268	75.0	117.0	8.30
A90121/64	21/64	8.33	0.3281	84.0	117.0	8.33
A9018.4	–	8.40	0.3307	75.0	117.0	8.40
A9018.5	–	8.50	0.3346	75.0	117.0	8.50
A9018.6	–	8.60	0.3386	81.0	125.0	8.60
A9018.7	–	8.70	0.3425	81.0	125.0	8.70
A90111/32	11/32	8.73	0.3438	87.0	121.0	8.73
A9018.8	–	8.80	0.3465	81.0	125.0	8.80
A9018.9	–	8.90	0.3504	81.0	125.0	8.90
A9019.0	–	9.00	0.3543	81.0	125.0	9.00
A9019.1	–	9.10	0.3583	81.0	125.0	9.10

Product	DC	DC	DC	LCF	OAL	DCON MS
	[inch]	[mm]	[inch]	[mm]	[mm]	[mm]
A90123/64	23/64	9.13	0.3594	89.0	124.0	9.13
A9019.2	–	9.20	0.3622	81.0	125.0	9.20
A9019.3	–	9.30	0.3661	81.0	125.0	9.30
A9019.4	–	9.40	0.3701	81.0	125.0	9.40
A9019.5	–	9.50	0.3740	81.0	125.0	9.50
A9013/8	3/8	9.52	0.3750	92.0	127.0	9.52
A9019.6	–	9.60	0.3780	87.0	133.0	9.60
A9019.7	–	9.70	0.3819	87.0	133.0	9.70
A9019.8	–	9.80	0.3858	87.0	133.0	9.80
A9019.9	–	9.90	0.3898	87.0	133.0	9.90
A90125/64	25/64	9.92	0.3906	95.0	130.0	9.92
A90110.0	–	10.00	0.3937	87.0	133.0	10.00
A90110.2	–	10.20	0.4016	87.0	133.0	10.20
A90110.3	–	10.30	0.4055	87.0	133.0	10.30
A90113/32	13/32	10.32	0.4063	98.0	133.0	10.32
A90110.4	–	10.40	0.4094	87.0	133.0	10.40
A90110.5	–	10.50	0.4134	87.0	133.0	10.50
A90127/64	27/64	10.72	0.4219	100.0	137.0	10.72
A90110.8	–	10.80	0.4252	94.0	142.0	10.80
A90111.0	–	11.00	0.4331	94.0	142.0	11.00
A9017/16	7/16	11.11	0.4375	103.0	140.0	11.11
A90111.5	–	11.50	0.4528	94.0	142.0	11.50
A90129/64	29/64	11.51	0.4531	106.0	143.0	11.51
A90111.8	–	11.80	0.4646	94.0	142.0	11.80
A90115/32	15/32	11.91	0.4688	110.0	146.0	11.91
A90112.0	–	12.00	0.4724	101.0	151.0	12.00
A90131/64	31/64	12.30	0.4844	111.0	149.0	12.30
A90112.5	–	12.50	0.4921	101.0	151.0	12.50
A9011/2	1/2	12.70	0.5000	101.0	151.0	12.70
A90113.0	–	13.00	0.5118	101.0	151.0	13.00
A90133/64	33/64	13.10	0.5156	122.0	168.0	13.10
A90113.5	–	13.50	0.5315	108.0	160.0	13.50
A90135/64	35/64	13.89	0.5469	122.0	168.0	13.89
A90114.0	–	14.00	0.5512	108.0	160.0	14.00
A9019/16	9/16	14.29	0.5625	122.0	168.0	14.29
A90114.5	–	14.50	0.5709	114.0	169.0	14.50
A90137/64	37/64	14.68	0.5781	122.0	168.0	14.68
A90115.0	–	15.00	0.5906	114.0	169.0	15.00
A90119/32	19/32	15.08	0.5938	132.0	181.0	15.08
A90139/64	39/64	15.48	0.6094	132.0	181.0	15.48
A90115.5	–	15.50	0.6102	120.0	178.0	15.50
A9015/8	5/8	15.88	0.6250	132.0	181.0	15.88
A90116.0	–	16.00	0.6299	120.0	178.0	16.00



A170



HSS Reduced Shank Drill, Steam Tempered Finish

A 1/2 inch parallel shank allows this drill, even with a large cutting diameter, to be clamped in conventional, hand-held power tools. A 118° point makes regrinding easy. Steam tempered finish retains cutting fluid and prevents chip to tool welding. Suitable for drilling many materials.

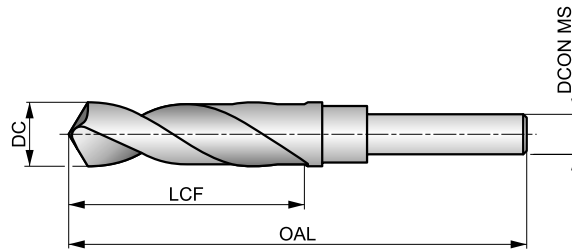

HSS	DORMER	4xD
118°	ST	
λ 20-35°	R	DC h8

Workpiece material group suitability, starting values for cutting speed (m/min) and feed Alpha Code. Tables with feed per revolution can be found starting from page 175.

P1.1 ■ 33 H	P1.2 ■ 37 H	P1.3 ■ 38 H	P2.1 ■ 28 H	P2.2 ■ 25 F	P2.3 ■ 22 D	P3.1 ■ 19 E	P3.2 ■ 15 E	P3.3 ■ 13 D	P4.1 ■ 11 E	P4.2 ■ 10 D	P4.3 ■ 8 C	M1.1 ■ 21 D	M1.2 ■ 17 D
M2.1 ■ 18 D	M2.2 ■ 15 D	M3.1 ■ 8 F	M3.2 ■ 7 F	M3.3 ■ 6 F	M4.1 ■ 7 B	K1.1 ■ 27 H	K1.2 ■ 20 E	K1.3 ■ 15 E	K2.1 ■ 23 D	K2.2 ■ 19 D	K2.3 ■ 15 D	K3.1 ■ 21 D	K3.2 ■ 16 D
K3.3 ■ 13 D	K4.1 ■ 19 D	K4.2 ■ 14 D	K4.3 ■ 11 D	K4.4 ■ 19 D	K4.5 ■ 8 D	K5.1 ■ 22 D	K5.2 ■ 16 D	K5.3 ■ 13 D	N1.1 ■ 33 I	N1.2 ■ 25 I	N1.3 ■ 17 H	N2.1 ■ 42 G	N2.2 ■ 37 G
N2.3 ■ 27 G	N3.1 ■ 56 G	N3.2 ■ 33 H	N3.3 ■ 17 F	N4.1 ■ 30 I	N4.2 ■ 28 G	N4.3 ■ 14 E	S1.1 ■ 17 E	S1.2 ■ 9 C	S1.3 ■ 5 A	S2.1 ■ 5 D	S2.2 ■ 4 A	S3.1 ■ 4 D	S3.2 ■ 3 A
S4.1 ■ 3 D	S4.2 ■ 2 A												

Product	DC	DC	DC	LCF	OAL	LCF	OAL	DCON MS
	[inch]	[mm]	[inch]	[inch]	[inch]	[mm]	[mm]	
A17013.0	–	13.00	0.5118	–	–	83.0	156.0	13.00
A17033/64	33/64	13.10	0.5156	3.1/8	6"	–	–	13.10
A17017/32	17/32	13.49	0.5313	3.1/8	6"	–	–	13.49
A17013.5	–	13.50	0.5315	–	–	83.0	156.0	13.50
A17035/64	35/64	13.89	0.5469	3.1/8	6"	–	–	13.89
A17014.0	–	14.00	0.5512	–	–	83.0	156.0	14.00
A1709/16	9/16	14.29	0.5625	3.1/8	6"	–	–	14.29
A17014.5	–	14.50	0.5709	–	–	83.0	156.0	14.50
A17037/64	37/64	14.68	0.5781	3.1/8	6"	–	–	14.68
A17015.0	–	15.00	0.5906	–	–	83.0	156.0	15.00
A17019/32	19/32	15.08	0.5938	3.1/8	6"	–	–	15.08
A17039/64	39/64	15.48	0.6094	3.1/8	6"	–	–	15.48
A17015.5	–	15.50	0.6102	–	–	83.0	156.0	15.50
A1705/8	5/8	15.88	0.6250	3.1/8	6"	–	–	15.88
A17016.0	–	16.00	0.6299	–	–	84.0	157.0	16.00
A17041/64	41/64	16.27	0.6406	3.1/8	6"	–	–	16.27
A17016.5	–	16.50	0.6496	–	–	84.0	157.0	16.50
A17021/32	21/32	16.67	0.6563	3.1/8	6"	–	–	16.67
A17017.0	–	17.00	0.6693	–	–	84.0	157.0	17.00
A17043/64	43/64	17.07	0.6719	3.1/8	6"	–	–	17.07
A17011/16	11/16	17.46	0.6875	3.1/8	6"	–	–	17.46
A17017.5	–	17.50	0.6890	–	–	84.0	157.0	17.50
A17045/64	45/64	17.86	0.7031	3.1/8	6"	–	–	17.86
A17018.0	–	18.00	0.7087	–	–	84.0	157.0	18.00



Product	DC	DC	DC	LCF	OAL	LCF	OAL	DCON MS
	[inch]	[mm]	[inch]	[inch]	[inch]	[mm]	[mm]	[mm]
A17023/32	23/32	18.26	0.7188	3.1/8	6"	—	—	18.26
A17018.5	—	18.50	0.7283	—	—	84.0	157.0	18.50
A17047/64	47/64	18.65	0.7344	3.1/8	6"	—	—	18.65
A17019.0	—	19.00	0.7480	—	—	84.0	157.0	19.00
A1703/4	3/4	19.05	0.7500	3.1/8	6"	—	—	19.05
A17049/64	49/64	19.45	0.7656	3"	6"	—	—	19.45
A17019.5	—	19.50	0.7677	—	—	81.0	158.0	19.50
A17025/32	25/32	19.84	0.7813	3"	6"	—	—	19.84
A17020.0	—	20.00	0.7874	—	—	81.0	158.0	20.00
A17051/64	51/64	20.24	0.7969	3"	6"	—	—	20.24
A17013/16	13/16	20.64	0.8125	3"	6"	—	—	20.64
A17021.0	—	21.00	0.8268	—	—	82.0	158.0	21.00
A17053/64	53/64	21.03	0.8281	3"	6"	—	—	21.03
A17027/32	27/32	21.43	0.8437	3"	6"	—	—	21.43
A17055/64	55/64	21.83	0.8594	3"	6"	—	—	21.83
A17022.0	—	22.00	0.8661	—	—	82.0	158.0	22.00
A1707/8	7/8	22.22	0.8750	3"	6"	—	—	22.22
A17057/64	57/64	22.62	0.8906	3"	6"	—	—	22.62
A17023.0	—	23.00	0.9055	—	—	82.0	158.0	23.00
A17029/32	29/32	23.02	0.9063	3"	6"	—	—	23.02
A17059/64	59/64	23.42	0.9219	3"	6"	—	—	23.42
A17015/16	15/16	23.81	0.9375	3"	6"	—	—	23.81
A17024.0	—	24.00	0.9449	—	—	83.0	159.0	24.00
A17061/64	61/64	24.21	0.9531	3"	6"	—	—	24.21
A17031/32	31/32	24.61	0.9688	3"	6"	—	—	24.61
A17025.0	—	25.00	0.9843	—	—	83.0	159.0	25.00
A17063/64	63/64	25.00	0.9844	3"	6"	—	—	25.00
A1701	1"	25.40	1.0000	3"	6"	—	—	25.40
A1701.1/32	1.1/32	26.19	1.0313	3"	6"	—	—	26.19
A1701.1/16	1.1/16	26.99	1.0625	3"	6"	—	—	26.99
A1701.7/64	1.7/64	28.18	1.1094	3"	6"	—	—	28.18
A1701.1/8	1.1/8	28.58	1.1250	3"	6"	—	—	28.58
A1701.9/64	1.9/64	28.97	1.1406	3"	6"	—	—	28.97
A1701.5/32	1.5/32	29.37	1.1563	3"	6"	—	—	29.37
A1701.3/16	1.3/16	30.16	1.1875	3"	6"	—	—	30.16
A1701.7/32	1.7/32	30.96	1.2188	3"	6"	—	—	30.96
A1701.1/4	1.1/4	31.75	1.2500	3"	6"	—	—	31.75
A1701.5/16	1.5/16	33.34	1.3125	3"	6"	—	—	33.34
A1701.3/8	1.3/8	34.93	1.3750	3"	6"	—	—	34.93
A1701.7/16	1.7/16	36.51	1.4375	3"	6"	—	—	36.51
A1701.1/2	1.1/2	38.10	1.5000	3"	6"	—	—	38.10



A243



HSS Long Series Aircraft Extension Drill, Bright Finish

NAS907 standard with a 135° split point which helps with self-centering, preventing the point of the drill from skidding over the surface of the material. Long overall length combined with a short flute length makes it ideal for drilling in difficult to reach areas and is suitable for many materials.

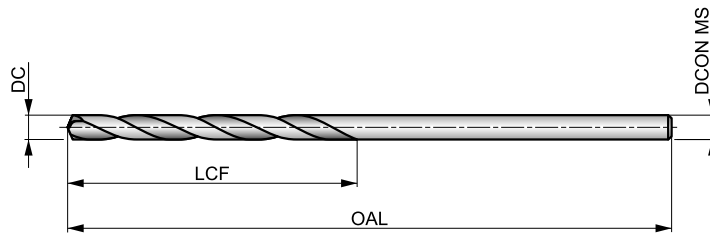

HSS	NAS 907	4xD
135°	Bright	
λ 20-35°	R	DC h8

Workpiece material group suitability, starting values for cutting speed (m/min) and feed Alpha Code. Tables with feed per revolution can be found starting from page 175.

P2.2 ▣ 25 F	P2.3 ▣ 22 E	P3.1 ▣ 19 F	P3.2 ▣ 15 F	P3.3 ▣ 13 E	P4.1 ▣ 11 F	P4.2 ▣ 10 E	P4.3 ▣ 8 D	M1.1 ▣ 21 E	M1.2 ▣ 17 E	M2.1 ▣ 18 E	M2.2 ▣ 15 E	M3.1 ▣ 9 G	M3.2 ▣ 8 G
M3.3 ▣ 7 G	M4.1 ▣ 9 C	K1.1 ▣ 30 I	K1.2 ▣ 22 F	K1.3 ▣ 17 F	K2.1 ▣ 25 E	K2.2 ▣ 20 E	K2.3 ▣ 16 E	K3.1 ▣ 22 E	K3.2 ▣ 17 E	K3.3 ▣ 13 E	K4.1 ▣ 20 E	K4.2 ▣ 15 E	K4.3 ▣ 11 E
K4.4 ▣ 10 E	K4.5 ▣ 8 E	K5.1 ▣ 23 E	K5.2 ▣ 17 E	K5.3 ▣ 13 E	N3.1 ▣ 27 H	S1.1 ▣ 23 F	S1.2 ▣ 12 D	S1.3 ▣ 6 B	S2.1 ▣ 8 E	S2.2 ▣ 4 A	S3.1 ▣ 6 E	S3.2 ▣ 3 A	S4.1 ▣ 5 E
S4.2 ▣ 2 A													

6" OAL.

Product	DC [inch]	DC [inch]	LCF [inch]	OAL [inch]	DCON MS [inch]
A2433/32X6	3/32	0.0938	1.1/4	6"	0.0938
A243N40X6	N40	0.0980	1.3/8	6"	0.0980
A2431/8X6	1/8	0.1250	1.5/8	6"	0.1250
A243N30X6	N30	0.1285	1.5/8	6"	0.1285
A2435/32X6	5/32	0.1563	2"	6"	0.1563
A243N21X6	N21	0.1590	2.1/8	6"	0.1590

Product	DC [inch]	DC [inch]	LCF [inch]	OAL [inch]	DCON MS [inch]
A243N20X6	N20	0.1610	2.1/8	6"	0.1610
A2433/16X6	3/16	0.1875	2.5/16	6"	0.1875
A243N11X6	N11	0.1910	2.5/16	6"	0.1910
A243N10X6	N10	0.1935	2.7/16	6"	0.1935
A2431/4X6	1/4	0.2500	2.3/4	6"	0.2500



A244



HSS Long Series Aircraft Extension Drill, Bright Finish

NAS907 standard with a 118° split point which helps with self-centering, stopping the point of the drill from skidding over the surface of the material. Long overall length combined with a short flute length makes it ideal for drilling in difficult to reach areas and is suitable for many materials.

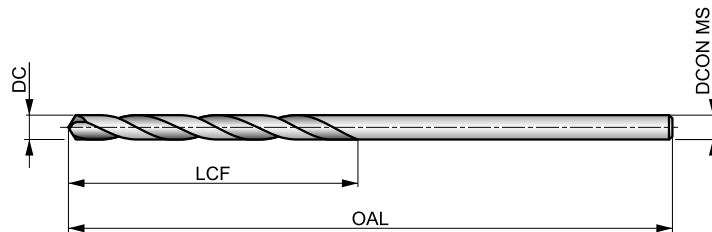

HSS	NAS 907	4×D
118°	Bright	
20-35°	R	DC h8

Workpiece material group suitability, starting values for cutting speed (m/min) and feed Alpha Code. Tables with feed per revolution can be found starting from page 175.

P2.2 ■ 25 F	P2.3 ■ 22 E	P3.1 ■ 19 F	P3.2 ■ 15 F	P3.3 ■ 13 E	P4.1 ■ 11 F	P4.2 ■ 10 E	P4.3 ■ 8 D	M1.1 ■ 21 E	M1.2 ■ 17 E	M2.1 ■ 18 E	M2.2 ■ 15 E	M3.1 ■ 9 G	M3.2 ■ 8 G
M3.3 ■ 7 G	M4.1 ■ 9 C	K1.1 ■ 30 I	K1.2 ■ 22 F	K1.3 ■ 17 F	K2.1 ■ 25 E	K2.2 ■ 20 E	K2.3 ■ 16 E	K3.1 ■ 22 E	K3.2 ■ 17 E	K3.3 ■ 13 E	K4.1 ■ 20 E	K4.2 ■ 15 E	K4.3 ■ 11 E
K4.4 ■ 10 E	K4.5 ■ 8 E	K5.1 ■ 23 E	K5.2 ■ 17 E	K5.3 ■ 13 E	N3.1 ■ 27 H	S1.1 ■ 23 F	S1.2 ■ 12 D	S1.3 ■ 6 B	S2.1 ■ 8 E	S2.2 ■ 4 A	S3.1 ■ 6 E	S3.2 ■ 3 A	S4.1 ■ 5 E
S4.2 ■ 2 A													

6°OAL.

Product	DC [inch]	DC [inch]	LCF [inch]	OAL [inch]	DCON MS [inch]
A2441/8X6	1/8	0.1250	1.5/8	6"	0.1250
A2445/32X6	5/32	0.1563	2"	6"	0.1563
A2443/16X6	3/16	0.1875	2.5/16	6"	0.1875
A2441/4X6	1/4	0.2500	2.3/4	6"	0.2500



A110



HSS Long Series Drill, Steam Tempered Finish

For drilling deeper holes. Conventional 118° point provides strength and means an easy point to regrind, making it very cost-effective. Suitable for drilling many materials. Steam tempered finish retains cutting fluid and prevents chip to tool welding. For hand-held and machine drilling.

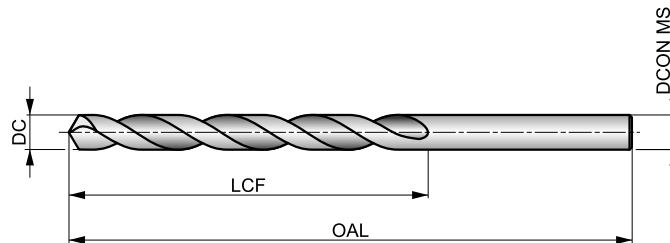

HSS	DIN 340	6xD
118°	ST	
λ 20-35°	R	DC h8

Workpiece material group suitability, starting values for cutting speed (m/min) and feed Alpha Code. Tables with feed per revolution can be found starting from page 175.

P1.1 ■ 27 G	P1.2 ■ 30 G	P1.3 ■ 31 G	P2.1 ■ 23 G	P2.2 ■ 20 E	P2.3 ■ 18 D	P3.1 ■ 13 E	P3.2 ■ 11 E	P3.3 ■ 9 D	P4.1 ■ 8 E	P4.2 ■ 7 D	P4.3 ■ 5 B	M1.1 ■ 14 D	M1.2 ■ 12 D
M2.1 ■ 12 D	M2.2 ■ 10 D	M3.1 ■ 7 F	M3.2 ■ 6 F	M3.3 ■ 5 F	M4.1 ■ 4 B	K1.1 ■ 28 H	K1.2 ■ 21 E	K1.3 ■ 16 E	K2.1 ■ 18 D	K2.2 ■ 15 D	K2.3 ■ 12 D	K3.1 ■ 16 D	K3.2 ■ 12 D
K3.3 ■ 10 D	K4.1 ■ 15 D	K4.2 ■ 11 D	K4.3 ■ 8 D	K4.4 ■ 7 D	K4.5 ■ 6 D	K5.1 ■ 17 D	K5.2 ■ 13 D	K5.3 ■ 10 D	N1.1 ■ 32 I	N1.2 ■ 24 I	N1.3 ■ 16 H	N2.1 ■ 42 G	N2.2 ■ 37 G
N2.3 ■ 27 G	N3.1 ■ 54 G	N3.2 ■ 32 H	N3.3 ■ 16 E	N4.1 ■ 35 I	N4.2 ■ 26 G	N4.3 ■ 12 E	S1.1 ■ 17 E	S1.2 ■ 9 C	S1.3 ■ 4 A	S2.1 ■ 5 D	S2.2 ■ 4 A	S3.1 ■ 4 D	S3.2 ■ 3 A
S4.1 ■ 3 D	S4.2 ■ 2 A												

DC ≤ 1mm; 1/16" Bright.

Product	DC [inch]	DC [mm]	DC [inch]	LCF [mm]	OAL [mm]	DCON MS [mm]
A110.5	-	0.50	0.0197	12.0	32.0	0.50
A110.6	-	0.60	0.0236	15.0	35.0	0.60
A110.7	-	0.70	0.0276	21.0	42.0	0.70
A1101/32	1/32	0.79	0.0313	25.0	46.0	0.79
A110.8	-	0.80	0.0315	25.0	46.0	0.80
A110.9	-	0.90	0.0354	29.0	51.0	0.90
A1101.0	-	1.00	0.0394	33.0	56.0	1.00
A1101.1	-	1.10	0.0433	37.0	60.0	1.10
A1101.2	-	1.20	0.0472	41.0	65.0	1.20
A1101.3	-	1.30	0.0512	41.0	65.0	1.30
A1101.4	-	1.40	0.0551	45.0	70.0	1.40
A1101.5	-	1.50	0.0591	45.0	70.0	1.50
A1101/16	1/16	1.59	0.0625	50.0	76.0	1.59
A1101.6	-	1.60	0.0630	50.0	76.0	1.60
A1101.7	-	1.70	0.0669	50.0	76.0	1.70
A1101.75	-	1.75	0.0689	53.0	80.0	1.75
A1101.8	-	1.80	0.0709	53.0	80.0	1.80
A1101.9	-	1.90	0.0748	53.0	80.0	1.90
A1105/64	5/64	1.98	0.0781	56.0	85.0	1.98
A1102.0	-	2.00	0.0787	56.0	85.0	2.00
A1102.05	-	2.05	0.0807	56.0	85.0	2.05
A1102.1	-	2.10	0.0827	56.0	85.0	2.10
A1102.2	-	2.20	0.0866	59.0	90.0	2.20
A1102.25	-	2.25	0.0886	59.0	90.0	2.25

Product	DC [inch]	DC [mm]	DC [inch]	LCF [mm]	OAL [mm]	DCON MS [mm]
A1102.3	-	2.30	0.0906	59.0	90.0	2.30
A1103/32	3/32	2.38	0.0938	62.0	95.0	2.38
A1102.4	-	2.40	0.0945	62.0	95.0	2.40
A1102.5	-	2.50	0.0984	62.0	95.0	2.50
A1102.6	-	2.60	0.1024	62.0	95.0	2.60
A1102.7	-	2.70	0.1063	66.0	100.0	2.70
A1107/64	7/64	2.78	0.1094	66.0	100.0	2.78
A1102.8	-	2.80	0.1102	66.0	100.0	2.80
A1102.9	-	2.90	0.1142	66.0	100.0	2.90
A1103.0	-	3.00	0.1181	66.0	100.0	3.00
A1103.1	-	3.10	0.1220	69.0	106.0	3.10
A1101/8	1/8	3.18	0.1250	69.0	106.0	3.18
A1103.2	-	3.20	0.1260	69.0	106.0	3.20
A1103.25	-	3.25	0.1280	69.0	106.0	3.25
A1103.3	-	3.30	0.1299	69.0	106.0	3.30
A1103.4	-	3.40	0.1339	73.0	112.0	3.40
A1103.5	-	3.50	0.1378	73.0	112.0	3.50
A1109/64	9/64	3.57	0.1406	73.0	112.0	3.57
A1103.6	-	3.60	0.1417	73.0	112.0	3.60
A1103.7	-	3.70	0.1457	73.0	112.0	3.70
A1103.75	-	3.75	0.1476	73.0	112.0	3.75
A1103.8	-	3.80	0.1496	78.0	119.0	3.80
A1103.9	-	3.90	0.1535	78.0	119.0	3.90
A1105/32	5/32	3.97	0.1563	78.0	119.0	3.97



Product	DC	DC	DC	LCF	OAL	D CON MS
	[inch]	[mm]	[inch]	[mm]	[mm]	[mm]
A1104.0	–	4.00	0.1575	78.0	119.0	4.00
A1104.1	–	4.10	0.1614	78.0	119.0	4.10
A1104.2	–	4.20	0.1654	78.0	119.0	4.20
A1104.25	–	4.25	0.1673	78.0	119.0	4.25
A1104.3	–	4.30	0.1693	82.0	126.0	4.30
A11011/64	11/64	4.37	0.1719	82.0	126.0	4.37
A1104.4	–	4.40	0.1732	82.0	126.0	4.40
A1104.5	–	4.50	0.1772	82.0	126.0	4.50
A1104.6	–	4.60	0.1811	82.0	126.0	4.60
A1104.7	–	4.70	0.1850	82.0	126.0	4.70
A1104.75	–	4.75	0.1870	82.0	126.0	4.75
A1103/16	3/16	4.76	0.1875	87.0	132.0	4.76
A1104.8	–	4.80	0.1890	87.0	132.0	4.80
A1104.9	–	4.90	0.1929	87.0	132.0	4.90
A1105.0	–	5.00	0.1969	87.0	132.0	5.00
A1105.1	–	5.10	0.2008	87.0	132.0	5.10
A11013/64	13/64	5.16	0.2031	87.0	132.0	5.16
A1105.2	–	5.20	0.2047	87.0	132.0	5.20
A1105.25	–	5.25	0.2067	87.0	132.0	5.25
A1105.3	–	5.30	0.2087	87.0	132.0	5.30
A1105.4	–	5.40	0.2126	91.0	139.0	5.40
A1105.5	–	5.50	0.2165	91.0	139.0	5.50
A1107/32	7/32	5.56	0.2188	91.0	139.0	5.56
A1105.6	–	5.60	0.2205	91.0	139.0	5.60
A1105.7	–	5.70	0.2244	91.0	139.0	5.70
A1105.75	–	5.75	0.2264	91.0	139.0	5.75
A1105.8	–	5.80	0.2283	91.0	139.0	5.80
A1105.9	–	5.90	0.2323	91.0	139.0	5.90
A11015/64	15/64	5.95	0.2344	91.0	139.0	5.95
A1106.0	–	6.00	0.2362	91.0	139.0	6.00
A1106.1	–	6.10	0.2402	97.0	148.0	6.10
A1106.2	–	6.20	0.2441	97.0	148.0	6.20
A1106.25	–	6.25	0.2461	97.0	148.0	6.25
A1106.3	–	6.30	0.2480	97.0	148.0	6.30
A1101/4	1/4	6.35	0.2500	97.0	148.0	6.35
A1106.4	–	6.40	0.2520	97.0	148.0	6.40
A1106.5	–	6.50	0.2559	97.0	148.0	6.50
A1106.6	–	6.60	0.2598	97.0	148.0	6.60
A1106.7	–	6.70	0.2638	97.0	148.0	6.70
A11017/64	17/64	6.75	0.2656	102.0	156.0	6.75
A1106.75	–	6.75	0.2657	102.0	156.0	6.75
A1106.8	–	6.80	0.2677	102.0	156.0	6.80
A1106.9	–	6.90	0.2717	102.0	156.0	6.90
A1107.0	–	7.00	0.2756	102.0	156.0	7.00
A1107.1	–	7.10	0.2795	102.0	156.0	7.10
A1109/32	9/32	7.14	0.2813	102.0	156.0	7.14
A1107.2	–	7.20	0.2835	102.0	156.0	7.20
A1107.25	–	7.25	0.2854	102.0	156.0	7.25
A1107.3	–	7.30	0.2874	102.0	156.0	7.30
A1107.4	–	7.40	0.2913	102.0	156.0	7.40
A1107.5	–	7.50	0.2953	102.0	156.0	7.50
A1107.6	–	7.60	0.2992	109.0	165.0	7.60
A1107.7	–	7.70	0.3031	109.0	165.0	7.70
A1107.75	–	7.75	0.3051	109.0	165.0	7.75
A1107.8	–	7.80	0.3071	109.0	165.0	7.80
A1107.9	–	7.90	0.3110	109.0	165.0	7.90
A1105/16	5/16	7.94	0.3125	109.0	165.0	7.94
A1108.0	–	8.00	0.3150	109.0	165.0	8.00
A1108.1	–	8.10	0.3189	109.0	165.0	8.10
A1108.2	–	8.20	0.3228	109.0	165.0	8.20
A1108.25	–	8.25	0.3248	109.0	165.0	8.25
A1108.3	–	8.30	0.3268	109.0	165.0	8.30
A1108.4	–	8.40	0.3307	109.0	165.0	8.40
A1108.5	–	8.50	0.3346	109.0	165.0	8.50
A1108.6	–	8.60	0.3386	115.0	175.0	8.60

Product	DC	DC	DC	LCF	OAL	D CON MS
	[inch]	[mm]	[inch]	[mm]	[mm]	[mm]
A1108.7	–	8.70	0.3425	115.0	175.0	8.70
A11011/32	11/32	8.73	0.3438	115.0	175.0	8.73
A1108.75	–	8.75	0.3445	115.0	175.0	8.75
A1108.8	–	8.80	0.3465	115.0	175.0	8.80
A1108.9	–	8.90	0.3504	115.0	175.0	8.90
A1109.0	–	9.00	0.3543	115.0	175.0	9.00
A1109.1	–	9.10	0.3583	115.0	175.0	9.10
A1109.2	–	9.20	0.3622	115.0	175.0	9.20
A1109.25	–	9.25	0.3642	115.0	175.0	9.25
A1109.3	–	9.30	0.3661	115.0	175.0	9.30
A1109.4	–	9.40	0.3701	115.0	175.0	9.40
A1109.5	–	9.50	0.3740	115.0	175.0	9.50
A1103/8	3/8	9.52	0.3750	121.0	184.0	9.52
A1109.6	–	9.60	0.3780	121.0	184.0	9.60
A1109.7	–	9.70	0.3819	121.0	184.0	9.70
A1109.75	–	9.75	0.3839	121.0	184.0	9.75
A1109.8	–	9.80	0.3858	121.0	184.0	9.80
A1109.9	–	9.90	0.3898	121.0	184.0	9.90
A11010.0	–	10.00	0.3937	121.0	184.0	10.00
A11010.1	–	10.10	0.3976	121.0	184.0	10.10
A11010.2	–	10.20	0.4016	121.0	184.0	10.20
A11010.25	–	10.25	0.4035	121.0	184.0	10.25
A11010.3	–	10.30	0.4055	121.0	184.0	10.30
A11013/32	13/32	10.32	0.4063	121.0	184.0	10.32
A11010.5	–	10.50	0.4134	121.0	184.0	10.50
A11010.75	–	10.75	0.4232	128.0	195.0	10.75
A11010.8	–	10.80	0.4252	128.0	195.0	10.80
A11011.0	–	11.00	0.4331	128.0	195.0	11.00
A1107/16	7/16	11.11	0.4375	128.0	195.0	11.11
A11011.25	–	11.25	0.4429	128.0	195.0	11.25
A11011.4	–	11.40	0.4488	128.0	195.0	11.40
A11011.5	–	11.50	0.4528	128.0	195.0	11.50
A11011.75	–	11.75	0.4626	128.0	195.0	11.75
A11012.0	–	12.00	0.4724	134.0	205.0	12.00
A11012.1	–	12.10	0.4764	134.0	205.0	12.10
A11012.25	–	12.25	0.4823	134.0	205.0	12.25
A11012.5	–	12.50	0.4921	134.0	205.0	12.50
A1101/2	1/2	12.70	0.5000	134.0	205.0	12.70
A11013.0	–	13.00	0.5118	134.0	205.0	13.00
A11017/32	17/32	13.49	0.5313	140.0	214.0	13.49
A11013.5	–	13.50	0.5315	140.0	214.0	13.50
A11014.0	–	14.00	0.5512	140.0	214.0	14.00
A1109/16	9/16	14.29	0.5625	144.0	220.0	14.29
A11014.5	–	14.50	0.5709	144.0	220.0	14.50
A11015.0	–	15.00	0.5906	144.0	220.0	15.00
A11015.5	–	15.50	0.6102	149.0	227.0	15.50
A1105/8	5/8	15.88	0.6250	149.0	227.0	15.88
A11016.0	–	16.00	0.6299	149.0	227.0	16.00
A11016.5	–	16.50	0.6496	154.0	235.0	16.50
A11017.0	–	17.00	0.6693	154.0	235.0	17.00
A11011/16	11/16	17.46	0.6875	158.0	241.0	17.46
A11017.5	–	17.50	0.6890	158.0	241.0	17.50
A11018.0	–	18.00	0.7087	158.0	241.0	18.00
A11018.5	–	18.50	0.7283	162.0	247.0	18.50
A11019.0	–	19.00	0.7480	162.0	247.0	19.00
A1103/4	3/4	19.05	0.7500	166.0	254.0	19.05
A11019.5	–	19.50	0.7677	166.0	254.0	19.50
A11020.0	–	20.00	0.7874	166.0	254.0	20.00
A11021.0	–	21.00	0.8268	171.0	261.0	21.00
A11022.0	–	22.00	0.8661	176.0	268.0	22.00
A1107/8	7/8	22.22	0.8750	176.0	268.0	22.22
A11015/16	15/16	23.81	0.9375	185.0	282.0	23.81
A1101	1"	25.40	1.0000	190.0	290.0	25.40



A940



PFX HSS-E (5% Cobalt) Long Series Drill, Bright Finish

High performance drill, able to produce high quality and accurate holes at high speeds and feeds (H10 hole tolerance). Self-centering 130° point angle and special parabolic flute design help to drill extra deep holes in a single pass. Suitable for many materials.

PFX

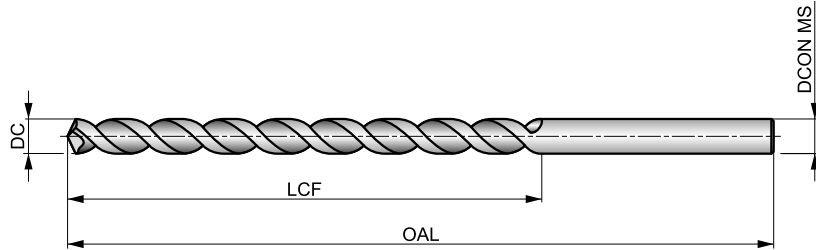

HSS-E	DIN ANSI	10xD
130°	Bright	
λ>35°	R	DC h8

Workpiece material group suitability, starting values for cutting speed (m/min) and feed Alpha Code. Tables with feed per revolution can be found starting from page 175.

P1.1 ■ 29 F	P1.2 ■ 33 F	P1.3 ■ 34 F	P2.1 ■ 25 F	P2.2 ■ 22 G	P2.3 ■ 19 C	P3.1 ■ 25 G	P3.2 ■ 20 G	P3.3 ■ 17 C	P4.1 ■ 15 G	P4.2 ■ 13 C	P4.3 ■ 10 C	M1.1 ■ 21 C	M1.2 ■ 17 C
M2.1 ■ 18 C	M2.2 ■ 15 C	M3.1 ■ 8 E	M3.2 ■ 7 E	M3.3 ■ 6 E	M4.1 ■ 9 B	K2.1 ■ 20 I	K2.2 ■ 16 I	K2.3 ■ 13 H	K3.1 ■ 17 I	K3.2 ■ 13 I	K3.3 ■ 11 H	K4.1 ■ 16 I	K4.2 ■ 12 I
K4.3 ■ 9 H	K4.4 ■ 8 H	K4.5 ■ 6 H	K5.1 ■ 18 I	K5.2 ■ 14 I	K5.3 ■ 11 H	N1.1 ■ 53 H	N1.2 ■ 40 H	N1.3 ■ 27 N	N2.1 ■ 62 N	N2.2 ■ 55 N	N2.3 ■ 40 N	N3.1 ■ 119 G	N3.2 ■ 70 F
N3.3 ■ 35 F	N4.1 ■ 55 H	N4.2 ■ 40 F	S1.1 ■ 18 E	S1.2 ■ 13 C	S1.3 ■ 6 C								

DC >= 9.6mm less than 10xD.

Product	DC	DC	DC	LCF	OAL	DCON MS
	[inch]	[mm]	[inch]			
A9401.0	-	1.00	0.0394	33.0	56.0	1.00
A9401.1	-	1.10	0.0433	37.0	60.0	1.10
A9403/64	3/64	1.19	0.0469	29.0	57.0	1.19
A9401.2	-	1.20	0.0472	41.0	65.0	1.20
A9401.3	-	1.30	0.0512	41.0	65.0	1.30
A9401.4	-	1.40	0.0551	45.0	70.0	1.40
A9401.5	-	1.50	0.0591	45.0	70.0	1.50
A9401/16	1/16	1.59	0.0625	44.0	76.0	1.59
A9401.6	-	1.60	0.0630	50.0	76.0	1.60
A9401.7	-	1.70	0.0669	50.0	76.0	1.70
A9401.8	-	1.80	0.0709	53.0	80.0	1.80
A9401.9	-	1.90	0.0748	53.0	80.0	1.90
A9405/64	5/64	1.98	0.0781	51.0	95.0	1.98
A9402.0	-	2.00	0.0787	56.0	85.0	2.00
A9402.1	-	2.10	0.0827	56.0	85.0	2.10
A9402.2	-	2.20	0.0866	59.0	90.0	2.20
A9402.3	-	2.30	0.0906	59.0	90.0	2.30
A9403/32	3/32	2.38	0.0938	57.0	108.0	2.38
A9402.4	-	2.40	0.0945	62.0	95.0	2.40
A9402.5	-	2.50	0.0984	62.0	95.0	2.50
A9402.6	-	2.60	0.1024	62.0	95.0	2.60
A9402.7	-	2.70	0.1063	66.0	100.0	2.70
A9407/64	7/64	2.78	0.1094	64.0	117.0	2.78
A9402.8	-	2.80	0.1102	66.0	100.0	2.80
A9402.9	-	2.90	0.1142	66.0	100.0	2.90

Product	DC	DC	DC	LCF	OAL	DCON MS
	[inch]	[mm]	[inch]			
A9403.0	-	3.00	0.1181	66.0	100.0	3.00
A9403.1	-	3.10	0.1220	69.0	106.0	3.10
A9401/8	1/8	3.18	0.1250	70.0	130.0	3.18
A9403.2	-	3.20	0.1260	69.0	106.0	3.20
A9403.3	-	3.30	0.1299	69.0	106.0	3.30
A9403.4	-	3.40	0.1339	73.0	112.0	3.40
A9403.5	-	3.50	0.1378	73.0	112.0	3.50
A9409/64	9/64	3.57	0.1406	76.0	137.0	3.57
A9403.6	-	3.60	0.1417	73.0	112.0	3.60
A9403.7	-	3.70	0.1457	73.0	112.0	3.70
A9403.8	-	3.80	0.1496	78.0	119.0	3.80
A9403.9	-	3.90	0.1535	78.0	119.0	3.90
A9405/32	5/32	3.97	0.1563	76.0	137.0	3.97
A9404.0	-	4.00	0.1575	78.0	119.0	4.00
A9404.1	-	4.10	0.1614	78.0	119.0	4.10
A9404.2	-	4.20	0.1654	78.0	119.0	4.20
A9404.3	-	4.30	0.1693	82.0	126.0	4.30
A94011/64	11/64	4.37	0.1719	86.0	146.0	4.37
A9404.4	-	4.40	0.1732	82.0	126.0	4.40
A9404.5	-	4.50	0.1772	82.0	126.0	4.50
A9404.6	-	4.60	0.1811	82.0	126.0	4.60
A9404.7	-	4.70	0.1850	82.0	126.0	4.70
A9403/16	3/16	4.76	0.1875	86.0	146.0	4.76
A9404.8	-	4.80	0.1890	87.0	132.0	4.80
A9404.9	-	4.90	0.1929	87.0	132.0	4.90



Product	DC	DC	DC	LCF	OAL	DCON MS
	[inch]	[mm]	[inch]	[mm]	[mm]	[mm]
A9405.0	–	5.00	0.1969	87.0	132.0	5.00
A9405.1	–	5.10	0.2008	87.0	132.0	5.10
A94013/64	13/64	5.16	0.2031	92.0	152.0	5.16
A9405.2	–	5.20	0.2047	87.0	132.0	5.20
A9405.3	–	5.30	0.2087	87.0	132.0	5.30
A9405.4	–	5.40	0.2126	91.0	139.0	5.40
A9405.5	–	5.50	0.2165	91.0	139.0	5.50
A9407/32	7/32	5.56	0.2188	92.0	152.0	5.56
A9405.6	–	5.60	0.2205	91.0	139.0	5.60
A9405.7	–	5.70	0.2244	91.0	139.0	5.70
A9405.8	–	5.80	0.2283	91.0	139.0	5.80
A9405.9	–	5.90	0.2323	91.0	139.0	5.90
A94015/64	15/64	5.95	0.2344	95.0	156.0	5.95
A9406.0	–	6.00	0.2362	91.0	139.0	6.00
A9406.1	–	6.10	0.2402	97.0	148.0	6.10
A9406.2	–	6.20	0.2441	97.0	148.0	6.20
A9406.3	–	6.30	0.2480	97.0	148.0	6.30
A9401/4	1/4	6.35	0.2500	95.0	156.0	6.35
A9406.4	–	6.40	0.2520	97.0	148.0	6.40
A9406.5	–	6.50	0.2559	97.0	148.0	6.50
A9406.6	–	6.60	0.2598	97.0	148.0	6.60
A9406.7	–	6.70	0.2638	97.0	148.0	6.70
A94017/64	17/64	6.75	0.2656	98.0	159.0	6.75
A9406.8	–	6.80	0.2677	102.0	156.0	6.80
A9406.9	–	6.90	0.2717	102.0	156.0	6.90
A9407.0	–	7.00	0.2756	102.0	156.0	7.00
A9407.1	–	7.10	0.2795	102.0	156.0	7.10
A9409/32	9/32	7.14	0.2813	98.0	159.0	7.14
A9407.2	–	7.20	0.2835	102.0	156.0	7.20
A9407.3	–	7.30	0.2874	102.0	156.0	7.30
A9407.4	–	7.40	0.2913	102.0	156.0	7.40
A9407.5	–	7.50	0.2953	102.0	156.0	7.50
A94019/64	19/64	7.54	0.2969	102.0	162.0	7.54
A9407.6	–	7.60	0.2992	109.0	165.0	7.60
A9407.7	–	7.70	0.3031	109.0	165.0	7.70
A9407.8	–	7.80	0.3071	109.0	165.0	7.80
A9407.9	–	7.90	0.3110	109.0	165.0	7.90
A9405/16	5/16	7.94	0.3125	102.0	162.0	7.94
A9408.0	–	8.00	0.3150	109.0	165.0	8.00
A9408.1	–	8.10	0.3189	109.0	165.0	8.10
A9408.2	–	8.20	0.3228	109.0	165.0	8.20
A9408.3	–	8.30	0.3268	109.0	165.0	8.30
A94021/64	21/64	8.33	0.3281	105.0	165.0	8.33
A9408.4	–	8.40	0.3307	109.0	165.0	8.40
A9408.5	–	8.50	0.3346	109.0	165.0	8.50
A9408.6	–	8.60	0.3386	115.0	175.0	8.60
A9408.7	–	8.70	0.3425	115.0	175.0	8.70
A94011/32	11/32	8.73	0.3438	105.0	165.0	8.73
A9408.8	–	8.80	0.3465	115.0	175.0	8.80
A9408.9	–	8.90	0.3504	115.0	175.0	8.90
A9409.0	–	9.00	0.3543	115.0	175.0	9.00
A9409.1	–	9.10	0.3583	115.0	175.0	9.10
A94023/64	23/64	9.13	0.3594	108.0	171.0	9.13
A9409.2	–	9.20	0.3622	115.0	175.0	9.20
A9409.3	–	9.30	0.3661	115.0	175.0	9.30
A9409.4	–	9.40	0.3701	115.0	175.0	9.40

Product	DC	DC	DC	LCF	OAL	DCON MS
	[inch]	[mm]	[inch]	[mm]	[mm]	[mm]
A9409.5	–	9.50	0.3740	115.0	175.0	9.50
A9403/8	3/8	9.52	0.3750	108.0	171.0	9.52
A9409.6	–	9.60	0.3780	121.0	184.0	9.60
A9409.7	–	9.70	0.3819	121.0	184.0	9.70
A9409.8	–	9.80	0.3858	121.0	184.0	9.80
A9409.9	–	9.90	0.3898	121.0	184.0	9.90
A94025/64	25/64	9.92	0.3906	111.0	178.0	9.92
A94010.0	–	10.00	0.3937	121.0	184.0	10.00
A94010.2	–	10.20	0.4016	121.0	184.0	10.20
A94010.3	–	10.30	0.4055	121.0	184.0	10.30
A94013/32	13/32	10.32	0.4063	111.0	178.0	10.32
A94010.5	–	10.50	0.4134	121.0	184.0	10.50
A94027/64	27/64	10.72	0.4219	117.0	184.0	10.72
A94011.0	–	11.00	0.4331	128.0	195.0	11.00
A9407/16	7/16	11.11	0.4375	117.0	184.0	11.11
A94011.2	–	11.20	0.4409	128.0	195.0	11.20
A94011.5	–	11.50	0.4528	128.0	195.0	11.50
A94029/64	29/64	11.51	0.4531	121.0	190.0	11.51
A94011.8	–	11.80	0.4646	128.0	195.0	11.80
A94015/32	15/32	11.91	0.4688	121.0	190.0	11.91
A94012.0	–	12.00	0.4724	134.0	205.0	12.00
A94012.2	–	12.20	0.4803	134.0	205.0	12.20
A94031/64	31/64	12.30	0.4844	121.0	197.0	12.30
A94012.5	–	12.50	0.4921	134.0	205.0	12.50
A9401/2	1/2	12.70	0.5000	121.0	197.0	12.70
A94013.0	–	13.00	0.5118	134.0	205.0	13.00
A94033/64	33/64	13.10	0.5156	121.0	203.0	13.10
A94017/32	17/32	13.49	0.5313	121.0	203.0	13.49
A94013.5	–	13.50	0.5315	140.0	214.0	13.50
A94035/64	35/64	13.89	0.5469	124.0	210.0	13.89
A94014.0	–	14.00	0.5512	140.0	214.0	14.00
A9409/16	9/16	14.29	0.5625	124.0	210.0	14.29
A94014.5	–	14.50	0.5709	144.0	220.0	14.50
A94037/64	37/64	14.68	0.5781	124.0	222.0	14.68
A94015.0	–	15.00	0.5906	144.0	220.0	15.00
A94019/32	19/32	15.08	0.5938	124.0	222.0	15.08
A94039/64	39/64	15.48	0.6094	124.0	222.0	15.48
A94015.5	–	15.50	0.6102	149.0	227.0	15.50
A9405/8	5/8	15.88	0.6250	124.0	222.0	15.88
A94016.0	–	16.00	0.6299	149.0	227.0	16.00
A94041/64	41/64	16.27	0.6406	130.0	229.0	16.27
A94016.5	–	16.50	0.6496	154.0	235.0	16.50
A94021/32	21/32	16.67	0.6563	130.0	229.0	16.67
A94017.0	–	17.00	0.6693	154.0	235.0	17.00
A94043/64	43/64	17.07	0.6719	137.0	235.0	17.07
A94011/16	11/16	17.46	0.6875	137.0	235.0	17.46
A94017.5	–	17.50	0.6890	158.0	241.0	17.50
A94045/64	45/64	17.86	0.7031	143.0	241.0	17.86
A94018.0	–	18.00	0.7087	158.0	241.0	18.00
A94023/32	23/32	18.26	0.7188	143.0	241.0	18.26
A94047/64	47/64	18.65	0.7344	149.0	248.0	18.65
A94019.0	–	19.00	0.7480	162.0	247.0	19.00
A9403/4	3/4	19.05	0.7500	149.0	248.0	19.05
A94049/64	49/64	19.45	0.7656	152.0	251.0	19.45
A94025/32	25/32	19.84	0.7813	152.0	251.0	19.84
A94020.0	–	20.00	0.7874	166.0	254.0	20.00



A941



PFX HSS-E (5% Cobalt) Long Series Drill, Alcrona Top Coated

High performance drill, able to produce high quality and accurate holes at high speeds and feeds (H10 hole tolerance). Self-centering 130° point angle and special parabolic flute design. Suitable for many materials. Alcrona-TOP coating improves performance and extends the tool life.



PFX

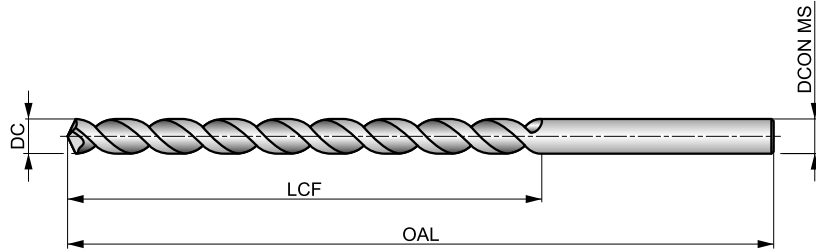

HSS-E	DIN ANSI	10xD
130°	Alcrona Top	
λ > 35°	R	DC h8

Workpiece material group suitability, starting values for cutting speed (m/min) and feed Alpha Code. Tables with feed per revolution can be found starting from page 175.

P1.1 ■ 48 G	P1.2 ■ 53 G	P1.3 ■ 55 G	P2.1 ■ 41 G	P2.2 ■ 36 G	P2.3 ■ 32 D	P3.1 ■ 34 G	P3.2 ■ 27 G	P3.3 ■ 23 D	P4.1 ■ 20 G	P4.2 ■ 17 D	P4.3 ■ 14 D	M1.1 ■ 23 C	M1.2 ■ 20 C
M2.1 ■ 21 C	M2.2 ■ 17 C	M3.1 ■ 10 E	M3.2 ■ 9 E	M3.3 ■ 8 E	M4.1 ■ 11 B	K1.1 ■ 36 I	K1.2 ■ 27 I	K1.3 ■ 20 I	K2.1 ■ 37 I	K2.2 ■ 30 I	K2.3 ■ 24 H	K3.1 ■ 33 I	K3.2 ■ 25 I
K3.3 ■ 20 H	K4.1 ■ 30 I	K4.2 ■ 23 I	K4.3 ■ 17 H	K4.4 ■ 14 H	K4.5 ■ 12 H	K5.1 ■ 34 I	K5.2 ■ 26 I	K5.3 ■ 20 H	S1.1 ■ 25 F	S1.2 ■ 18 D	S1.3 ■ 18 D		

DC >= 9.6mm less than 10xD.

Product	DC	DC	DC	LCF	OAL	DCON MS
	[inch]	[mm]	[inch]			
A9411.0	-	1.00	0.0394	33.0	56.0	1.00
A9413/64	3/64	1.19	0.0469	29.0	57.0	1.19
A9411.5	-	1.50	0.0591	45.0	70.0	1.50
A9411/16	1/16	1.59	0.0625	44.0	76.0	1.59
A9415/64	5/64	1.98	0.0781	51.0	95.0	1.98
A9412.0	-	2.00	0.0787	56.0	85.0	2.00
A9413/32	3/32	2.38	0.0938	57.0	108.0	2.38
A9412.5	-	2.50	0.0984	62.0	95.0	2.50
A9417/64	7/64	2.78	0.1094	64.0	117.0	2.78
A9413.0	-	3.00	0.1181	66.0	100.0	3.00
A9413.1	-	3.10	0.1220	69.0	106.0	3.10
A9411/8	1/8	3.18	0.1250	70.0	130.0	3.18
A9413.2	-	3.20	0.1260	69.0	106.0	3.20
A9413.3	-	3.30	0.1299	69.0	106.0	3.30
A9413.4	-	3.40	0.1339	73.0	112.0	3.40
A9413.5	-	3.50	0.1378	73.0	112.0	3.50
A9419/64	9/64	3.57	0.1406	76.0	137.0	3.57
A9413.6	-	3.60	0.1417	73.0	112.0	3.60
A9413.7	-	3.70	0.1457	73.0	112.0	3.70
A9413.8	-	3.80	0.1496	78.0	119.0	3.80
A9413.9	-	3.90	0.1535	78.0	119.0	3.90
A9415/32	5/32	3.97	0.1563	76.0	137.0	3.97
A9414.0	-	4.00	0.1575	78.0	119.0	4.00
A9414.1	-	4.10	0.1614	78.0	119.0	4.10
A9414.2	-	4.20	0.1654	78.0	119.0	4.20
A9414.3	-	4.30	0.1693	82.0	126.0	4.30
A94111/64	11/64	4.37	0.1719	86.0	146.0	4.37

Product	DC	DC	DC	LCF	OAL	DCON MS
	[inch]	[mm]	[inch]			
A9414.4	-	4.40	0.1732	82.0	126.0	4.40
A9414.5	-	4.50	0.1772	82.0	126.0	4.50
A9414.6	-	4.60	0.1811	82.0	126.0	4.60
A9414.7	-	4.70	0.1850	82.0	126.0	4.70
A9413/16	3/16	4.76	0.1875	86.0	146.0	4.76
A9414.8	-	4.80	0.1890	87.0	132.0	4.80
A9414.9	-	4.90	0.1929	87.0	132.0	4.90
A9415.0	-	5.00	0.1969	87.0	132.0	5.00
A9415.1	-	5.10	0.2008	87.0	132.0	5.10
A94113/64	13/64	5.16	0.2031	92.0	152.0	5.16
A9415.2	-	5.20	0.2047	87.0	132.0	5.20
A9415.3	-	5.30	0.2087	87.0	132.0	5.30
A9415.4	-	5.40	0.2126	91.0	139.0	5.40
A9415.5	-	5.50	0.2165	91.0	139.0	5.50
A9417/32	7/32	5.56	0.2188	92.0	152.0	5.56
A9415.6	-	5.60	0.2205	91.0	139.0	5.60
A9415.7	-	5.70	0.2244	91.0	139.0	5.70
A9415.8	-	5.80	0.2283	91.0	139.0	5.80
A9415.9	-	5.90	0.2323	91.0	139.0	5.90
A94115/64	15/64	5.95	0.2344	95.0	156.0	5.95
A9416.0	-	6.00	0.2362	91.0	139.0	6.00
A9416.1	-	6.10	0.2402	97.0	148.0	6.10
A9416.2	-	6.20	0.2441	97.0	148.0	6.20
A9416.3	-	6.30	0.2480	97.0	148.0	6.30
A9411/4	1/4	6.35	0.2500	95.0	156.0	6.35
A9416.4	-	6.40	0.2520	97.0	148.0	6.40
A9416.5	-	6.50	0.2559	97.0	148.0	6.50



Product	DC	DC	DC	LCF	OAL	DCON MS
	[inch]	[mm]	[inch]	[mm]	[mm]	[mm]
A9416.6	–	6.60	0.2598	97.0	148.0	6.60
A9416.7	–	6.70	0.2638	97.0	148.0	6.70
A94117/64	17/64	6.75	0.2656	98.0	159.0	6.75
A9416.8	–	6.80	0.2677	102.0	156.0	6.80
A9416.9	–	6.90	0.2717	102.0	156.0	6.90
A9417.0	–	7.00	0.2756	102.0	156.0	7.00
A9417.1	–	7.10	0.2795	102.0	156.0	7.10
A9419/32	9/32	7.14	0.2813	98.0	159.0	7.14
A9417.2	–	7.20	0.2835	102.0	156.0	7.20
A9417.3	–	7.30	0.2874	102.0	156.0	7.30
A9417.4	–	7.40	0.2913	102.0	156.0	7.40
A9417.5	–	7.50	0.2953	102.0	156.0	7.50
A94119/64	19/64	7.54	0.2969	102.0	162.0	7.54
A9417.6	–	7.60	0.2992	109.0	165.0	7.60
A9417.7	–	7.70	0.3031	109.0	165.0	7.70
A9417.8	–	7.80	0.3071	109.0	165.0	7.80
A9417.9	–	7.90	0.3110	109.0	165.0	7.90
A9415/16	5/16	7.94	0.3125	102.0	162.0	7.94
A9418.0	–	8.00	0.3150	109.0	165.0	8.00
A9418.1	–	8.10	0.3189	109.0	165.0	8.10
A9418.2	–	8.20	0.3228	109.0	165.0	8.20
A9418.3	–	8.30	0.3268	109.0	165.0	8.30
A94121/64	21/64	8.33	0.3281	105.0	165.0	8.33
A9418.4	–	8.40	0.3307	109.0	165.0	8.40
A9418.5	–	8.50	0.3346	109.0	165.0	8.50
A9418.6	–	8.60	0.3386	115.0	175.0	8.60
A9418.7	–	8.70	0.3425	115.0	175.0	8.70
A94111/32	11/32	8.73	0.3438	105.0	165.0	8.73
A9418.8	–	8.80	0.3465	115.0	175.0	8.80
A9418.9	–	8.90	0.3504	115.0	175.0	8.90
A9419.0	–	9.00	0.3543	115.0	175.0	9.00
A9419.1	–	9.10	0.3583	115.0	175.0	9.10
A94123/64	23/64	9.13	0.3594	108.0	171.0	9.13
A9419.2	–	9.20	0.3622	115.0	175.0	9.20
A9419.3	–	9.30	0.3661	115.0	175.0	9.30
A9419.4	–	9.40	0.3701	115.0	175.0	9.40
A9419.5	–	9.50	0.3740	115.0	175.0	9.50
A9413/8	3/8	9.52	0.3750	108.0	171.0	9.52

Product	DC	DC	DC	LCF	OAL	DCON MS
	[inch]	[mm]	[inch]	[mm]	[mm]	[mm]
A9419.6	–	9.60	0.3780	121.0	184.0	9.60
A9419.7	–	9.70	0.3819	121.0	184.0	9.70
A9419.8	–	9.80	0.3858	121.0	184.0	9.80
A9419.9	–	9.90	0.3898	121.0	184.0	9.90
A94125/64	25/64	9.92	0.3906	111.0	178.0	9.92
A94110.0	–	10.00	0.3937	121.0	184.0	10.00
A94110.2	–	10.20	0.4016	121.0	184.0	10.20
A94110.3	–	10.30	0.4055	121.0	184.0	10.30
A94113/32	13/32	10.32	0.4063	111.0	178.0	10.32
A94110.5	–	10.50	0.4134	121.0	184.0	10.50
A94127/64	27/64	10.72	0.4219	117.0	184.0	10.72
A94111.0	–	11.00	0.4331	128.0	195.0	11.00
A9417/16	7/16	11.11	0.4375	117.0	184.0	11.11
A94111.2	–	11.20	0.4409	128.0	195.0	11.20
A94111.5	–	11.50	0.4528	128.0	195.0	11.50
A94129/64	29/64	11.51	0.4531	121.0	190.0	11.51
A94111.8	–	11.80	0.4646	128.0	195.0	11.80
A94115/32	15/32	11.91	0.4688	121.0	190.0	11.91
A94112.0	–	12.00	0.4724	134.0	205.0	12.00
A94112.2	–	12.20	0.4803	134.0	205.0	12.20
A94131/64	31/64	12.30	0.4844	121.0	197.0	12.30
A94112.5	–	12.50	0.4921	134.0	205.0	12.50
A9411/2	1/2	12.70	0.5000	121.0	197.0	12.70
A94113.0	–	13.00	0.5118	134.0	205.0	13.00
A94133/64	33/64	13.10	0.5156	121.0	203.0	13.10
A94113.5	–	13.50	0.5315	140.0	214.0	13.50
A94135/64	35/64	13.89	0.5469	124.0	210.0	13.89
A94114.0	–	14.00	0.5512	140.0	214.0	14.00
A9419/16	9/16	14.29	0.5625	124.0	210.0	14.29
A94114.5	–	14.50	0.5709	144.0	220.0	14.50
A94137/64	37/64	14.68	0.5781	124.0	222.0	14.68
A94115.0	–	15.00	0.5906	144.0	220.0	15.00
A94119/32	19/32	15.08	0.5938	124.0	222.0	15.08
A94139/64	39/64	15.48	0.6094	124.0	222.0	15.48
A94115.5	–	15.50	0.6102	149.0	227.0	15.50
A9415/8	5/8	15.88	0.6250	124.0	222.0	15.88
A94116.0	–	16.00	0.6299	149.0	227.0	16.00



A125



HSS Extra Long Series Drill, Steam Tempered Finish

With Steam tempered finish and recommended for very deep or difficult to reach holes. Conventional 118° point, providing strength and saving money on easy regrinds. Suitable for many materials. Steam tempered finish retains cutting fluid and prevents chip to tool welding. Less suitable for hand-held drilling.

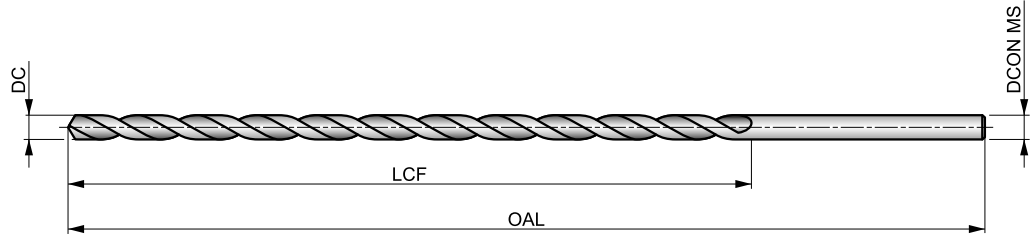

HSS	BS 328	10×D
118°	ST	
λ 20-35°	R	DC h8

Workpiece material group suitability, starting values for cutting speed (m/min) and feed Alpha Code. Tables with feed per revolution can be found starting from page 175.

P1.1 ■ 21 E	P1.2 ■ 24 E	P1.3 ■ 25 E	P2.1 ■ 18 E	P2.2 ■ 16 C	P2.3 ■ 14 A	P3.1 ■ 9 C	P3.2 ■ 7 C	P3.3 ■ 6 A	P4.1 ■ 5 C	P4.2 ■ 4 A	P4.3 ■ 4 A	M1.1 ■ 12 C	M1.2 ■ 10 C
M2.1 ■ 11 C	M2.2 ■ 9 C	M3.1 ■ 5 E	M3.2 ■ 4 E	M3.3 ■ 4 E	M4.1 ■ 8 A	K1.1 ■ 22 G	K1.2 ■ 16 D	K1.3 ■ 12 D	K2.1 ■ 16 C	K2.2 ■ 13 C	K2.3 ■ 10 C	K3.1 ■ 14 C	K3.2 ■ 11 C
K3.3 ■ 9 C	K4.1 ■ 13 C	K4.2 ■ 10 C	K4.3 ■ 7 C	K4.4 ■ 6 C	K4.5 ■ 5 C	K5.1 ■ 15 C	K5.2 ■ 11 C	K5.3 ■ 9 C	N1.1 ■ 24 H	N1.2 ■ 18 H	N1.3 ■ 12 G	N2.1 ■ 34 F	N2.2 ■ 30 F
N2.3 ■ 22 F	N3.1 ■ 56 F	N3.2 ■ 33 G	N3.3 ■ 17 D	N4.1 ■ 30 H	N4.2 ■ 26 F	N4.3 ■ 10 D	S1.1 ■ 11 D	S1.2 ■ 9 B	S1.3 ■ 5 A	S2.1 ■ 5 C	S2.2 ■ 4 A	S3.1 ■ 4 C	S3.2 ■ 3 A
S4.1 ■ 3 C	S4.2 ■ 2 A												

DC <= 2.2mm; 5/64" Bright.

Product	DC [inch]	DC [mm]	DC [inch]	LCF [mm]	OAL [mm]	DCON MS [mm]
A1251.4X160	-	1.40	0.0551	100.0	160.0	1.40
A1251.5X125	-	1.50	0.0591	80.0	125.0	1.50
A1251.5X160	-	1.50	0.0591	100.0	160.0	1.50
A1251/16X125	1/16	1.59	0.0625	80.0	125.0	1.59
A1251/16X160	1/16	1.59	0.0625	100.0	160.0	1.59
A1251.8X160	-	1.80	0.0709	100.0	160.0	1.80
A1255/64X125	5/64	1.98	0.0781	80.0	125.0	1.98
A1255/64X160	5/64	1.98	0.0781	100.0	160.0	1.98
A1252.0X125	-	2.00	0.0787	80.0	125.0	2.00
A1252.0X160	-	2.00	0.0787	100.0	160.0	2.00
A1252.2X160	-	2.20	0.0866	100.0	160.0	2.20
A1253/32X125	3/32	2.38	0.0938	80.0	125.0	2.38
A1253/32X160	3/32	2.38	0.0938	100.0	160.0	2.38
A1252.5X125	-	2.50	0.0984	80.0	125.0	2.50
A1252.5X160	-	2.50	0.0984	100.0	160.0	2.50
A1257/64X125	7/64	2.78	0.1094	80.0	125.0	2.78
A1257/64X160	7/64	2.78	0.1094	100.0	160.0	2.78
A1253.0X160	-	3.00	0.1181	100.0	160.0	3.00
A1253.0X200	-	3.00	0.1181	150.0	200.0	3.00
A1253.0X250	-	3.00	0.1181	200.0	250.0	3.00
A1251/8X160	1/8	3.18	0.1252	100.0	160.0	3.18
A1251/8X200	1/8	3.18	0.1252	150.0	200.0	3.18
A1251/8X250	1/8	3.18	0.1252	200.0	250.0	3.18
A1251/8X315	1/8	3.18	0.1252	250.0	310.0	3.18
A1253.3X160	-	3.30	0.1299	100.0	160.0	3.30
A1253.5X160	-	3.50	0.1378	100.0	160.0	3.50

Product	DC [inch]	DC [mm]	DC [inch]	LCF [mm]	OAL [mm]	DCON MS [mm]
A1253.5X200	-	3.50	0.1378	150.0	200.0	3.50
A1253.5X250	-	3.50	0.1378	200.0	250.0	3.50
A1259/64X160	9/64	3.57	0.1406	100.0	160.0	3.57
A1259/64X200	9/64	3.57	0.1406	150.0	200.0	3.57
A1259/64X315	9/64	3.57	0.1406	250.0	310.0	3.57
A1255/32X160	5/32	3.97	0.1563	100.0	160.0	3.97
A1255/32X200	5/32	3.97	0.1563	150.0	200.0	3.97
A1255/32X250	5/32	3.97	0.1563	200.0	250.0	3.97
A1255/32X315	5/32	3.97	0.1563	250.0	310.0	3.97
A1254.0X160	-	4.00	0.1575	100.0	160.0	4.00
A1254.0X200	-	4.00	0.1575	150.0	200.0	4.00
A1254.0X250	-	4.00	0.1575	200.0	250.0	4.00
A1254.0X315	-	4.00	0.1575	250.0	310.0	4.00
A12511/64X160	11/64	4.37	0.1719	100.0	160.0	4.37
A12511/64X200	11/64	4.37	0.1719	150.0	200.0	4.37
A12511/64X315	11/64	4.37	0.1719	250.0	310.0	4.37
A1254.5X160	-	4.50	0.1772	100.0	160.0	4.50
A1254.5X200	-	4.50	0.1772	150.0	200.0	4.50
A1254.5X250	-	4.50	0.1772	200.0	250.0	4.50
A1254.5X315	-	4.50	0.1772	250.0	310.0	4.50
A1253/16X160	3/16	4.76	0.1875	100.0	160.0	4.76
A1253/16X200	3/16	4.76	0.1875	150.0	200.0	4.76
A1253/16X250	3/16	4.76	0.1875	200.0	250.0	4.76
A1253/16X315	3/16	4.76	0.1875	250.0	310.0	4.76
A1253/16X400	3/16	4.76	0.1875	300.0	400.0	4.76
A1255.0X160	-	5.00	0.1969	100.0	160.0	5.00



Product	DC	DC	DC	LCF	OAL	DCON MS
	[inch]	[mm]	[inch]	[mm]	[mm]	[mm]
A1255.0X200	—	5.00	0.1969	150.0	200.0	5.00
A1255.0X250	—	5.00	0.1969	200.0	250.0	5.00
A1255.0X315	—	5.00	0.1969	250.0	310.0	5.00
A1255.0X400	—	5.00	0.1969	300.0	400.0	5.00
A12513/64X200	13/64	5.16	0.2031	150.0	200.0	5.16
A12513/64X250	13/64	5.16	0.2031	200.0	250.0	5.16
A12513/64X315	13/64	5.16	0.2031	250.0	310.0	5.16
A1255.5X200	—	5.50	0.2165	150.0	200.0	5.50
A1255.5X250	—	5.50	0.2165	200.0	250.0	5.50
A1255.5X315	—	5.50	0.2165	250.0	310.0	5.50
A1257/32X200	7/32	5.56	0.2188	150.0	200.0	5.56
A1257/32X250	7/32	5.56	0.2188	200.0	250.0	5.56
A1257/32X315	7/32	5.56	0.2188	250.0	310.0	5.56
A12515/64X200	15/64	5.95	0.2344	150.0	200.0	5.95
A12515/64X250	15/64	5.95	0.2344	200.0	250.0	5.95
A12515/64X315	15/64	5.95	0.2344	250.0	310.0	5.95
A1256.0X200	—	6.00	0.2362	150.0	200.0	6.00
A1256.0X250	—	6.00	0.2362	200.0	250.0	6.00
A1256.0X315	—	6.00	0.2362	250.0	310.0	6.00
A1256.0X400	—	6.00	0.2362	300.0	400.0	6.00
A1251/4X200	1/4	6.35	0.2500	150.0	200.0	6.35
A1251/4X250	1/4	6.35	0.2500	200.0	250.0	6.35
A1251/4X315	1/4	6.35	0.2500	250.0	310.0	6.35
A1251/4X400	1/4	6.35	0.2500	300.0	400.0	6.35
A1251/4X500	1/4	6.35	0.2500	400.0	460.0	6.35
A1256.5X200	—	6.50	0.2559	150.0	200.0	6.50
A1256.5X250	—	6.50	0.2559	200.0	250.0	6.50
A1256.5X315	—	6.50	0.2559	250.0	310.0	6.50
A12517/64X200	17/64	6.75	0.2656	150.0	200.0	6.75
A12517/64X250	17/64	6.75	0.2656	200.0	250.0	6.75
A12517/64X500	17/64	6.75	0.2656	400.0	460.0	6.75
A1257.0X200	—	7.00	0.2756	150.0	200.0	7.00
A1257.0X250	—	7.00	0.2756	200.0	250.0	7.00
A1257.0X315	—	7.00	0.2756	250.0	310.0	7.00
A1259/32X200	9/32	7.14	0.2813	150.0	200.0	7.14
A1259/32X250	9/32	7.14	0.2813	200.0	250.0	7.14
A1259/32X315	9/32	7.14	0.2813	250.0	310.0	7.14
A1259/32X500	9/32	7.14	0.2813	400.0	460.0	7.14
A1257.5X200	—	7.50	0.2953	150.0	200.0	7.50
A1257.5X250	—	7.50	0.2953	200.0	250.0	7.50
A1257.5X315	—	7.50	0.2953	250.0	310.0	7.50
A12519/64X315	19/64	7.54	0.2969	250.0	310.0	7.54
A12519/64X500	19/64	7.54	0.2969	400.0	460.0	7.54
A1255/16X200	5/16	7.94	0.3125	150.0	200.0	7.94
A1255/16X250	5/16	7.94	0.3125	200.0	250.0	7.94
A1255/16X315	5/16	7.94	0.3125	250.0	310.0	7.94
A1255/16X400	5/16	7.94	0.3125	300.0	400.0	7.94
A1255/16X500	5/16	7.94	0.3125	400.0	460.0	7.94
A1258.0X250	—	8.00	0.3150	200.0	250.0	8.00
A1258.0X315	—	8.00	0.3150	250.0	310.0	8.00
A1258.0X400	—	8.00	0.3150	300.0	400.0	8.00
A12521/64X315	21/64	8.33	0.3281	250.0	310.0	8.33
A12521/64X500	21/64	8.33	0.3281	400.0	460.0	8.33
A1258.5X250	—	8.50	0.3346	200.0	250.0	8.50
A1258.5X315	—	8.50	0.3346	250.0	310.0	8.50
A12511/32X250	11/32	8.73	0.3438	200.0	250.0	8.73
A12511/32X315	11/32	8.73	0.3438	250.0	310.0	8.73
A12511/32X400	11/32	8.73	0.3438	300.0	400.0	8.73
A12511/32X500	11/32	8.73	0.3438	400.0	460.0	8.73
A1259.0X250	—	9.00	0.3543	200.0	250.0	9.00
A1259.0X315	—	9.00	0.3543	250.0	310.0	9.00
A1259.0X400	—	9.00	0.3543	300.0	400.0	9.00
A12523/64X315	23/64	9.13	0.3594	250.0	310.0	9.13
A12523/64X500	23/64	9.13	0.3594	400.0	460.0	9.13
A1259.5X250	—	9.50	0.3740	200.0	250.0	9.50
A1259.5X315	—	9.50	0.3740	250.0	310.0	9.50
A1253/8X250	3/8	9.52	0.3750	200.0	250.0	9.52
A1253/8X315	3/8	9.52	0.3750	250.0	310.0	9.52
A1253/8X400	3/8	9.52	0.3750	300.0	400.0	9.52

Product	DC	DC	DC	LCF	OAL	DCON MS
	[inch]	[mm]	[inch]	[mm]	[mm]	[mm]
A1253/8X500	3/8	9.52	0.3750	400.0	460.0	9.52
A12525/64X315	25/64	9.92	0.3906	250.0	310.0	9.92
A12525/64X500	25/64	9.92	0.3906	400.0	460.0	9.92
A12510.0X250	—	10.00	0.3937	200.0	250.0	10.00
A12510.0X315	—	10.00	0.3937	250.0	310.0	10.00
A12510.0X400	—	10.00	0.3937	300.0	400.0	10.00
A12513/32X250	13/32	10.32	0.4063	200.0	250.0	10.32
A12513/32X315	13/32	10.32	0.4063	250.0	310.0	10.32
A12513/32X500	13/32	10.32	0.4063	400.0	460.0	10.32
A12510.5X250	—	10.50	0.4134	200.0	250.0	10.50
A12510.5X315	—	10.50	0.4134	250.0	310.0	10.50
A12510.5X400	—	10.50	0.4134	300.0	400.0	10.50
A12527/64X315	27/64	10.72	0.4219	250.0	310.0	10.72
A12511.0X250	—	11.00	0.4331	200.0	250.0	11.00
A12511.0X315	—	11.00	0.4331	250.0	310.0	11.00
A12511.0X400	—	11.00	0.4331	300.0	400.0	11.00
A1257/16X250	7/16	11.11	0.4375	200.0	250.0	11.11
A1257/16X315	7/16	11.11	0.4375	250.0	310.0	11.11
A1257/16X400	7/16	11.11	0.4375	300.0	400.0	11.11
A1257/16X500	7/16	11.11	0.4375	400.0	460.0	11.11
A12529/64X315	29/64	11.51	0.4531	250.0	310.0	11.51
A12529/64X500	29/64	11.51	0.4531	400.0	460.0	11.51
A12515/32X250	15/32	11.91	0.4688	200.0	250.0	11.91
A12515/32X315	15/32	11.91	0.4688	250.0	310.0	11.91
A12515/32X500	15/32	11.91	0.4688	400.0	460.0	11.91
A12512.0X250	—	12.00	0.4724	200.0	250.0	12.00
A12512.0X315	—	12.00	0.4724	250.0	310.0	12.00
A12512.0X400	—	12.00	0.4724	300.0	400.0	12.00
A12531/64X315	31/64	12.30	0.4844	250.0	310.0	12.30
A12531/64X500	31/64	12.30	0.4844	400.0	460.0	12.30
A1251/2X250	1/2	12.70	0.5000	200.0	250.0	12.70
A1251/2X315	1/2	12.70	0.5000	250.0	310.0	12.70
A1251/2X400	1/2	12.70	0.5000	300.0	400.0	12.70
A1251/2X500	1/2	12.70	0.5000	400.0	460.0	12.70
A12513.0X315	—	13.00	0.5118	250.0	310.0	13.00
A12513.0X400	—	13.00	0.5118	300.0	400.0	13.00
A12533/64X315	33/64	13.10	0.5156	250.0	310.0	13.10
A12533/64X500	33/64	13.10	0.5156	400.0	460.0	13.10
A12517/32X315	17/32	13.49	0.5313	250.0	310.0	13.49
A12517/32X500	17/32	13.49	0.5313	400.0	460.0	13.49
A12535/64X315	35/64	13.89	0.5469	250.0	310.0	13.89
A12535/64X500	35/64	13.89	0.5469	400.0	460.0	13.89
A12514.0X315	—	14.00	0.5512	250.0	310.0	14.00
A12514.0X400	—	14.00	0.5512	300.0	400.0	14.00
A1259/16X315	9/16	14.29	0.5625	250.0	310.0	14.29
A1259/16X500	9/16	14.29	0.5625	400.0	460.0	14.29
A12537/64X315	37/64	14.68	0.5781	250.0	310.0	14.68
A12519/32X315	19/32	15.08	0.5938	250.0	310.0	15.08
A12519/32X500	19/32	15.08	0.5938	400.0	460.0	15.08
A12539/64X315	39/64	15.48	0.6094	250.0	310.0	15.48
A12539/64X500	39/64	15.48	0.6094	400.0	460.0	15.48
A1255/8X315	5/8	15.88	0.6250	250.0	310.0	15.88
A1255/8X500	5/8	15.88	0.6250	400.0	460.0	15.88
A12521/32X315	21/32	16.67	0.6563	250.0	310.0	16.67
A12521/32X500	21/32	16.67	0.6563	400.0	460.0	16.67
A12511/16X315	11/16	17.46	0.6875	250.0	310.0	17.46
A12511/16X500	11/16	17.46	0.6875	400.0	460.0	17.46
A12523/32X315	23/32	18.26	0.7188	250.0	310.0	18.26
A12523/32X500	23/32	18.26	0.7188	400.0	460.0	18.26
A1253/4X315	3/4	19.05	0.7500	250.0	310.0	19.05
A1253/4X500	3/4	19.05	0.7500	400.0	460.0	19.05
A12525/32X500	25/32	19.84	0.7813	400.0	460.0	19.84
A12513/16X500	13/16	20.64	0.8125	400.0	460.0	20.64
A1257/8X500	7/8	22.22	0.8750	400.0	460.0	22.22
A12515/16X500	15/16	23.81	0.9375	400.0	460.0	23.81
A1251X500	1"	25.40	1.0000	400.0	460.0	25.40



A976



PFX HSS-E (5% Cobalt) Extra Long Series Drill (DIN 1869 Series 1), Bright Finish

Recommended for drilling very deep holes or for applications where extra reach is needed. Specially designed parabolic flutes eliminate the need to drill deep holes in short steps (pecking). A 130° point. Centering with a short 3xD PFX drill is recommended (to keep same DC tolerance). Suitable for drilling many materials.

PFX

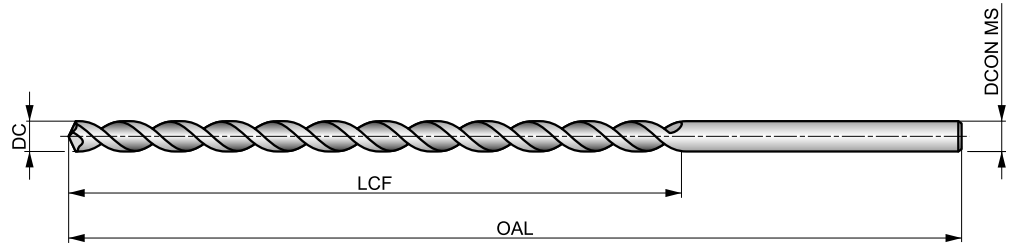

HSS-E	DIN 1869-1	15×D
130°	Bright	
λ>35°	R	DC h8

Workpiece material group suitability, starting values for cutting speed (m/min) and feed Alpha Code. Tables with feed per revolution can be found starting from page 175.

P1.1 ■29 C	P1.2 ■33 C	P1.3 ■34 C	P2.1 ■25 C	P2.2 ■22 C	P2.3 ■19 A	P3.1 ■18 C	P3.2 ■14 C	P3.3 ■12 A	P4.1 ■11 C	P4.2 ■9 A	P4.3 ■7 A	M1.1 ■16 B	M1.2 ■14 B
M2.1 ■15 B	M2.2 ■12 B	M3.1 ■8 C	M3.2 ■7 C	M3.3 ■6 C	M4.1 ■8 A	K2.1 ■20 C	K2.2 ■16 C	K2.3 ■13 A	K3.1 ■17 C	K3.2 ■13 C	K3.3 ■11 A	K4.1 ■16 C	K4.2 ■12 C
K4.3 ■9 A	K4.4 ■8 A	K4.5 ■6 A	K5.1 ■18 C	K5.2 ■14 C	K5.3 ■11 A	N3.1 ■30 D	S1.1 ■15 C	S1.2 ■11 A	S1.3 ■5 A				

Product	DC [inch]	DC [mm]	DC [inch]	LCF [mm]	OAL [mm]	DCON MS [mm]
A9761.5	–	1.50	0.0591	75.0	115.0	1.50
A9762.0X125	–	2.00	0.0787	85.0	125.0	2.00
A9762.1X125	–	2.10	0.0827	85.0	125.0	2.10
A9762.2X135	–	2.20	0.0866	90.0	135.0	2.20
A9762.3X135	–	2.30	0.0906	90.0	135.0	2.30
A9762.4X140	–	2.40	0.0945	95.0	140.0	2.40
A9762.5X140	–	2.50	0.0984	95.0	140.0	2.50
A9762.6X140	–	2.60	0.1024	95.0	140.0	2.60
A9762.7X150	–	2.70	0.1063	100.0	150.0	2.70
A9762.8X150	–	2.80	0.1102	100.0	150.0	2.80
A9762.9X150	–	2.90	0.1142	100.0	150.0	2.90
A9763.0X150	–	3.00	0.1181	100.0	150.0	3.00
A9763.1X155	–	3.10	0.1220	105.0	155.0	3.10
A9761/8	1/8	3.18	0.1252	105.0	155.0	3.18
A9763.2X155	–	3.20	0.1260	105.0	155.0	3.20
A9763.3X155	–	3.30	0.1299	105.0	155.0	3.30
A9763.4X165	–	3.40	0.1339	115.0	165.0	3.40
A9763.5X165	–	3.50	0.1378	115.0	165.0	3.50
A9763.6X165	–	3.60	0.1417	115.0	165.0	3.60
A9763.7X165	–	3.70	0.1457	115.0	165.0	3.70
A9763.8X175	–	3.80	0.1496	120.0	175.0	3.80
A9763.9X175	–	3.90	0.1535	120.0	175.0	3.90
A9765/32	5/32	3.97	0.1563	120.0	175.0	3.97
A9764.0X175	–	4.00	0.1575	120.0	175.0	4.00
A9764.1X175	–	4.10	0.1614	120.0	175.0	4.10
A9764.2X175	–	4.20	0.1654	120.0	175.0	4.20
A9764.3X185	–	4.30	0.1693	125.0	185.0	4.30
A9764.4X185	–	4.40	0.1732	125.0	185.0	4.40

Product	DC [inch]	DC [mm]	DC [inch]	LCF [mm]	OAL [mm]	DCON MS [mm]
A9764.5X185	–	4.50	0.1772	125.0	185.0	4.50
A9764.6X185	–	4.60	0.1811	125.0	185.0	4.60
A9764.7X185	–	4.70	0.1850	125.0	185.0	4.70
A9763/16	3/16	4.76	0.1875	135.0	195.0	4.76
A9764.8X195	–	4.80	0.1890	135.0	195.0	4.80
A9764.9X195	–	4.90	0.1929	135.0	195.0	4.90
A9765.0X195	–	5.00	0.1969	135.0	195.0	5.00
A9765.1X195	–	5.10	0.2008	135.0	195.0	5.10
A9765.2X195	–	5.20	0.2047	135.0	195.0	5.20
A9765.3X195	–	5.30	0.2087	135.0	195.0	5.30
A9765.4X205	–	5.40	0.2126	140.0	205.0	5.40
A9765.5X205	–	5.50	0.2165	140.0	205.0	5.50
A9765.6X205	–	5.60	0.2205	140.0	205.0	5.60
A9765.7X205	–	5.70	0.2244	140.0	205.0	5.70
A9765.8X205	–	5.80	0.2283	140.0	205.0	5.80
A9765.9X205	–	5.90	0.2323	140.0	205.0	5.90
A9766.0X205	–	6.00	0.2362	140.0	205.0	6.00
A9766.1X215	–	6.10	0.2402	150.0	215.0	6.10
A9766.2X215	–	6.20	0.2441	150.0	215.0	6.20
A9766.3X215	–	6.30	0.2480	150.0	215.0	6.30
A9761/4	1/4	6.35	0.2500	150.0	215.0	6.35
A9766.4X215	–	6.40	0.2520	150.0	215.0	6.40
A9766.5X215	–	6.50	0.2559	150.0	215.0	6.50
A9766.6X215	–	6.60	0.2598	150.0	215.0	6.60
A9766.7X215	–	6.70	0.2638	150.0	215.0	6.70
A9766.8X225	–	6.80	0.2677	155.0	225.0	6.80
A9766.9X225	–	6.90	0.2717	155.0	225.0	6.90
A9767.0X225	–	7.00	0.2756	155.0	225.0	7.00



Product	DC	DC	DC	LCF	OAL	DCON MS
	[inch]	[mm]	[inch]	[mm]	[mm]	[mm]
A9767.5X225	–	7.50	0.2953	155.0	225.0	7.50
A9765/16	5/16	7.94	0.3125	165.0	240.0	7.94
A9768.0X240	–	8.00	0.3150	165.0	240.0	8.00
A9768.5X240	–	8.50	0.3346	165.0	240.0	8.50
A97611/32	11/32	8.73	0.3438	175.0	250.0	8.73
A9769.0X250	–	9.00	0.3543	175.0	250.0	9.00
A9769.5X250	–	9.50	0.3740	175.0	250.0	9.50
A9763/8	3/8	9.52	0.3750	185.0	265.0	9.52
A97610.0X265	–	10.00	0.3937	185.0	265.0	10.00

¹⁾ Dormer Standard.

Product	DC	DC	DC	LCF	OAL	DCON MS
	[inch]	[mm]	[inch]	[mm]	[mm]	[mm]
A97610.5	–	10.50	0.4134	185.0	265.0	10.50
A97611.0	–	11.00	0.4331	195.0	280.0	11.00
A9767/16	7/16	11.11	0.4375	195.0	280.0	11.11
A97611.5	–	11.50	0.4528	195.0	280.0	11.50
A97612.0	–	12.00	0.4724	205.0	295.0	12.00
A97612.5	–	12.50	0.4921	205.0	295.0	12.50
A9761/2	1/2	12.70	0.5000	205.0	295.0	12.70
A97613.0	–	13.00	0.5118	205.0	295.0	13.00
A97614.0¹⁾	–	14.00	0.5512	215.0	310.0	14.00



A977



PFX HSS-E (5% Cobalt) Extra Long Drill (DIN 1869 Series 2), Bright Finish

Recommended for drilling very deep holes and in applications where extra reach is needed. Specially designed parabolic flutes eliminate the need to drill deep holes in short steps (pecking). A 130° point. Centering with a short 3xD PFX drill is recommended (to keep same DC tolerance). Suitable for drilling many materials.

PFX

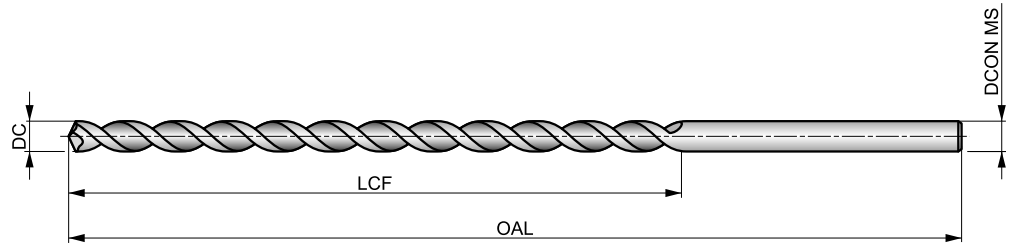

HSS-E	DIN 1869-2	20xD
130°	Bright	
λ > 35°	R	DC h8

Workpiece material group suitability, starting values for cutting speed (m/min) and feed Alpha Code. Tables with feed per revolution can be found starting from page 175.

P1.1 ▣29 B	P1.2 ▣33 B	P1.3 ▣34 B	P2.1 ▣25 B	P2.2 ▣22 B	P2.3 ▣19 A	P3.1 ▣18 B	P3.2 ▣14 B	P3.3 ▣12 A	P4.1 ▣11 B	P4.2 ▣9 A	P4.3 ▣7 A	M1.1 ▣16 B	M1.2 ▣14 B
M2.1 ▣15 B	M2.2 ▣12 B	M3.1 ▣8 B	M3.2 ▣7 B	M3.3 ▣6 B	M4.1 ▣8 A	K2.1 ▣20 B	K2.2 ▣16 B	K2.3 ▣13 A	K3.1 ▣17 B	K3.2 ▣13 B	K3.3 ▣11 A	K4.1 ▣16 B	K4.2 ▣12 B
K4.3 ▣9 A	K4.4 ▣8 A	K4.5 ▣6 A	K5.1 ▣18 B	K5.2 ▣14 B	K5.3 ▣11 A	N3.1 ▣30 C	S1.1 ▣15 B	S1.2 ▣11 A	S1.3 ▣5 A				

Product	DC [inch]	DC [mm]	DC [inch]	LCF [mm]	OAL [mm]	DCON MS [mm]
A9771.5 ¹⁾	—	1.50	0.0591	100.0	150.0	1.50
A9771/16 ¹⁾	1/16	1.59	0.0625	100.0	150.0	1.59
A9772.0 ¹⁾	—	2.00	0.0787	110.0	160.0	2.00
A9773/32 ¹⁾	3/32	2.38	0.0938	115.0	170.0	2.38
A9773.0X190	—	3.00	0.1181	130.0	190.0	3.00
A9771/8	1/8	3.18	0.1250	135.0	200.0	3.18
A9773.5X210	—	3.50	0.1378	145.0	210.0	3.50
A9774.0X220	—	4.00	0.1575	150.0	220.0	4.00
A9774.5X235	—	4.50	0.1772	160.0	235.0	4.50
A9773/16	3/16	4.76	0.1875	170.0	245.0	4.76
A9775.0X245	—	5.00	0.1969	170.0	245.0	5.00
A9775.5X260	—	5.50	0.2165	180.0	260.0	5.50
A9776.0X260	—	6.00	0.2362	180.0	260.0	6.00
A9771/4	1/4	6.35	0.2500	190.0	275.0	6.35
A9776.5X275	—	6.50	0.2559	190.0	275.0	6.50

Product	DC [inch]	DC [mm]	DC [inch]	LCF [mm]	OAL [mm]	DCON MS [mm]
A9777.0X290	—	7.00	0.2756	200.0	290.0	7.00
A9777.5X290	—	7.50	0.2953	200.0	290.0	7.50
A9778.0X305	—	8.00	0.3150	210.0	305.0	8.00
A9778.5X305	—	8.50	0.3346	210.0	305.0	8.50
A97711/32	11/32	8.73	0.3438	220.0	320.0	8.73
A9779.0X320	—	9.00	0.3543	220.0	320.0	9.00
A9779.5X320	—	9.50	0.3740	220.0	320.0	9.50
A97710.0X340	—	10.00	0.3937	235.0	340.0	10.00
A97710.5	—	10.50	0.4134	235.0	340.0	10.50
A97711.0	—	11.00	0.4331	250.0	365.0	11.00
A97711.5	—	11.50	0.4528	250.0	365.0	11.50
A97712.0	—	12.00	0.4724	260.0	375.0	12.00
A97712.5	—	12.50	0.4921	260.0	375.0	12.50
A97713.0	—	13.00	0.5118	260.0	375.0	13.00
A97714.0 ¹⁾	—	14.00	0.5512	270.0	390.0	14.00

¹⁾ Dormer Standard.



A978



PFX HSS-E (5% Cobalt) Extra Long Drill (DIN 1869 Series 3), Bright Finish

Recommended for extra deep holes and in applications where extra reach is needed. Specially designed parabolic flutes eliminate the need to drill deep holes in short steps (pecking). A 130° point. Centering with a short 3xD PFX drill is recommended (to keep same DC tolerance). Suitable for drilling many materials.

PFX

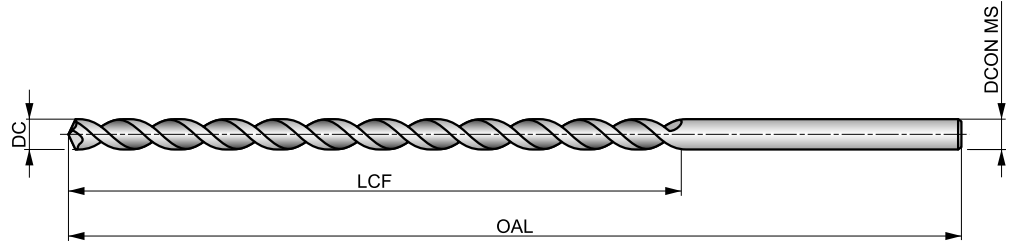

HSS-E	DIN 1869-3	25xD
130°	Bright	
$\lambda > 35^\circ$	R	DC h8

Workpiece material group suitability, starting values for cutting speed (m/min) and feed Alpha Code. Tables with feed per revolution can be found starting from page 175.

P1.1 ▣29 A	P1.2 ▣33 A	P1.3 ▣34 A	P2.1 ▣25 A	P2.2 ▣22 A	P2.3 ▣19 A	P3.1 ▣18 A	P3.2 ▣14 A	P3.3 ▣12 A	P4.1 ▣11 A	P4.2 ▣9 A	P4.3 ▣7 A	M1.1 ▣16 A	M1.2 ▣14 A
M2.1 ▣15 A	M2.2 ▣12 A	M3.1 ▣8 A	M3.2 ▣17 A	M3.3 ▣6 A	M4.1 ▣8 A	K2.1 ▣20 A	K2.2 ▣16 A	K2.3 ▣13 A	K3.1 ▣17 A	K3.2 ▣13 A	K3.3 ▣11 A	K4.1 ▣16 A	K4.2 ▣12 A
K4.3 ▣9 A	K4.4 ▣8 A	K4.5 ▣6 A	K5.1 ▣18 A	K5.2 ▣14 A	K5.3 ▣11 A	N3.1 ▣30 B	S1.1 ▣15 A	S1.2 ▣11 A	S1.3 ▣5 A				

Product	DC	DC	DC	LCF	OAL	DCON MS
	[inch]	[mm]	[inch]	[mm]	[mm]	[mm]
A9783.0 ¹⁾	–	3.00	0.1181	160.0	240.0	3.00
A9783.5X265	–	3.50	0.1378	180.0	265.0	3.50
A9784.0X280	–	4.00	0.1575	190.0	280.0	4.00
A9784.5X295	–	4.50	0.1772	200.0	295.0	4.50
A9785.0X315	–	5.00	0.1969	210.0	315.0	5.00
A9785.5X330	–	5.50	0.2165	225.0	330.0	5.50
A9786.0X330	–	6.00	0.2362	225.0	330.0	6.00
A9781/4	1/4	6.35	0.2500	235.0	350.0	6.35
A9786.5X350	–	6.50	0.2559	235.0	350.0	6.50
A9787.0X370	–	7.00	0.2756	250.0	370.0	7.00
A9787.5X370	–	7.50	0.2953	250.0	370.0	7.50
A9788.0X390	–	8.00	0.3150	265.0	390.0	8.00
A9788.5X390	–	8.50	0.3346	265.0	390.0	8.50
A9789.0X410	–	9.00	0.3543	280.0	410.0	9.00
A9789.5X410	–	9.50	0.3740	280.0	410.0	9.50
A97810.0X430	–	10.00	0.3937	295.0	430.0	10.00

¹⁾ Dormer Standard.



A130



HSS Taper Shank Drill, Steam Tempered Finish

Versatile drill with larger diameters - up to 50.80mm (2 inches). Tapered shank provides a better grip for holding it in the machine. Conventional 118° point provides strength and makes it easy to regrind. Steam tempered finish retains cutting fluid and prevents chip to tool welding. Suitable for drilling many materials.

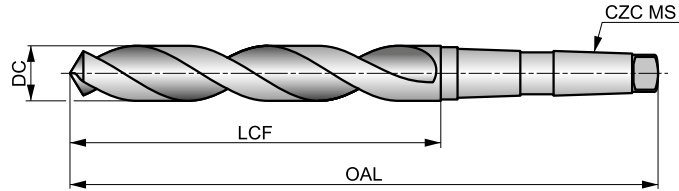

HSS	DIN 345	4xD
118°	ST	
λ 20-35°	R	DC h8

Workpiece material group suitability, starting values for cutting speed (m/min) and feed Alpha Code. Tables with feed per revolution can be found starting from page 175.

P1.1 ■ 33 I	P1.2 ■ 37 I	P1.3 ■ 38 I	P2.1 ■ 28 I	P2.2 ■ 25 F	P2.3 ■ 22 E	P3.1 ■ 18 F	P3.2 ■ 14 F	P3.3 ■ 12 E	P4.1 ■ 11 F	P4.2 ■ 9 E	P4.3 ■ 7 D	M1.1 ■ 21 E	M1.2 ■ 17 E
M2.1 ■ 18 E	M2.2 ■ 15 E	M3.1 ■ 10 G	M3.2 ■ 9 G	M3.3 ■ 8 G	M4.1 ■ 10 C	K1.1 ■ 30 I	K1.2 ■ 22 E	K1.3 ■ 17 E	K2.1 ■ 25 E	K2.2 ■ 20 E	K2.3 ■ 16 E	K3.1 ■ 22 E	K3.2 ■ 17 E
K3.3 ■ 13 E	K4.1 ■ 20 E	K4.2 ■ 15 E	K4.3 ■ 11 E	K4.4 ■ 10 E	K4.5 ■ 8 E	K5.1 ■ 23 E	K5.2 ■ 17 E	K5.3 ■ 13 E	N1.1 ■ 26 J	N1.2 ■ 20 J	N1.3 ■ 13 I	N2.1 ■ 43 H	N2.2 ■ 39 H
N2.3 ■ 28 H	N3.1 ■ 59 H	N3.2 ■ 35 I	N3.3 ■ 18 F	N4.1 ■ 30 K	N4.2 ■ 28 J	N4.3 ■ 14 H	S1.1 ■ 23 F	S1.2 ■ 13 D	S1.3 ■ 7 B	S2.1 ■ 9 E	S2.2 ■ 6 A	S3.1 ■ 7 E	S3.2 ■ 4 A
S4.1 ■ 5 E	S4.2 ■ 3 A												

DC > 14mm Point Thinned.

Product	DC	DC	DC	LCF	OAL	CZC MS
	[inch]	[mm]	[inch]	[mm]	[mm]	
A1303.0	—	3.00	0.1181	33.0	114.0	MK 1
A1301/8	1/8	3.18	0.1252	36.0	117.0	MK 1
A1303.2	—	3.20	0.1260	36.0	117.0	MK 1
A1303.25	—	3.25	0.1280	36.0	117.0	MK 1
A1303.3	—	3.30	0.1299	36.0	117.0	MK 1
A1303.5	—	3.50	0.1378	39.0	120.0	MK 1
A1309/64	9/64	3.57	0.1406	39.0	120.0	MK 1
A1303.75	—	3.75	0.1476	39.0	120.0	MK 1
A1305/32	5/32	3.97	0.1563	43.0	124.0	MK 1
A1304.0	—	4.00	0.1575	43.0	124.0	MK 1
A1304.1	—	4.10	0.1614	43.0	124.0	MK 1
A1304.2	—	4.20	0.1654	43.0	124.0	MK 1
A1304.25	—	4.25	0.1673	43.0	124.0	MK 1
A13011/64	11/64	4.37	0.1719	47.0	128.0	MK 1
A1304.5	—	4.50	0.1772	47.0	128.0	MK 1
A1304.75	—	4.75	0.1870	52.0	128.0	MK 1
A1303/16	3/16	4.76	0.1875	52.0	133.0	MK 1
A1304.8	—	4.80	0.1890	52.0	133.0	MK 1
A1304.9	—	4.90	0.1929	52.0	133.0	MK 1
A1305.0	—	5.00	0.1969	52.0	133.0	MK 1
A1305.1	—	5.10	0.2008	52.0	133.0	MK 1
A13013/64	13/64	5.16	0.2031	52.0	133.0	MK 1
A1305.2	—	5.20	0.2047	52.0	133.0	MK 1



Product	DC	DC	DC	LCF	OAL	CZC MS
	[inch]	[mm]	[inch]	[mm]	[mm]	
A1305.25	–	5.25	0.2067	52.0	133.0	MK 1
A1305.4	–	5.40	0.2126	57.0	138.0	MK 1
A1305.5	–	5.50	0.2165	57.0	138.0	MK 1
A1307/32	7/32	5.56	0.2188	57.0	138.0	MK 1
A1305.7	–	5.70	0.2244	57.0	138.0	MK 1
A1305.75	–	5.75	0.2264	57.0	138.0	MK 1
A1305.8	–	5.80	0.2283	57.0	138.0	MK 1
A1305.9	–	5.90	0.2323	57.0	138.0	MK 1
A13015/64	15/64	5.95	0.2344	57.0	138.0	MK 1
A1306.0	–	6.00	0.2362	57.0	138.0	MK 1
A1306.1	–	6.10	0.2402	63.0	144.0	MK 1
A1306.2	–	6.20	0.2441	63.0	144.0	MK 1
A1306.25	–	6.25	0.2461	63.0	144.0	MK 1
A1306.3	–	6.30	0.2480	63.0	144.0	MK 1
A1301/4	1/4	6.35	0.2500	63.0	144.0	MK 1
A1306.4	–	6.40	0.2520	63.0	144.0	MK 1
A1306.5	–	6.50	0.2559	63.0	144.0	MK 1
A1306.6	–	6.60	0.2598	63.0	144.0	MK 1
A1306.7	–	6.70	0.2638	63.0	144.0	MK 1
A13017/64	17/64	6.75	0.2656	69.0	150.0	MK 1
A1306.75	–	6.75	0.2657	69.0	150.0	MK 1
A1306.8	–	6.80	0.2677	69.0	150.0	MK 1
A1306.9	–	6.90	0.2717	69.0	150.0	MK 1
A1307.0	–	7.00	0.2756	69.0	150.0	MK 1
A1309/32	9/32	7.14	0.2813	69.0	150.0	MK 1
A1307.2	–	7.20	0.2835	69.0	150.0	MK 1
A1307.25	–	7.25	0.2854	69.0	150.0	MK 1
A1307.3	–	7.30	0.2874	69.0	150.0	MK 1
A1307.4	–	7.40	0.2913	69.0	150.0	MK 1
A1307.5	–	7.50	0.2953	69.0	150.0	MK 1
A13019/64	19/64	7.54	0.2969	75.0	156.0	MK 1
A1307.7	–	7.70	0.3031	75.0	156.0	MK 1
A1307.75	–	7.75	0.3051	75.0	156.0	MK 1
A1307.8	–	7.80	0.3071	75.0	156.0	MK 1
A1307.9	–	7.90	0.3110	75.0	156.0	MK 1
A1305/16	5/16	7.94	0.3125	75.0	156.0	MK 1
A1308.0	–	8.00	0.3150	75.0	156.0	MK 1
A1308.1	–	8.10	0.3189	75.0	156.0	MK 1
A1308.2	–	8.20	0.3228	75.0	156.0	MK 1
A1308.25	–	8.25	0.3248	75.0	156.0	MK 1
A1308.3	–	8.30	0.3268	75.0	156.0	MK 1
A13021/64	21/64	8.33	0.3281	75.0	156.0	MK 1
A1308.4	–	8.40	0.3307	75.0	156.0	MK 1
A1308.5	–	8.50	0.3346	75.0	156.0	MK 1
A1308.6	–	8.60	0.3386	81.0	162.0	MK 1
A1308.7	–	8.70	0.3425	81.0	162.0	MK 1
A13011/32	11/32	8.73	0.3438	81.0	162.0	MK 1
A1308.75	–	8.75	0.3445	81.0	162.0	MK 1
A1308.8	–	8.80	0.3465	81.0	162.0	MK 1
A1308.9	–	8.90	0.3504	81.0	162.0	MK 1
A1309.0	–	9.00	0.3543	81.0	162.0	MK 1
A1309.1	–	9.10	0.3583	81.0	162.0	MK 1
A13023/64	23/64	9.13	0.3594	81.0	162.0	MK 1
A1309.2	–	9.20	0.3622	81.0	162.0	MK 1
A1309.25	–	9.25	0.3642	81.0	162.0	MK 1
A1309.3	–	9.30	0.3661	81.0	162.0	MK 1
A1309.5	–	9.50	0.3740	81.0	162.0	MK 1
A1303/8	3/8	9.52	0.3750	87.0	168.0	MK 1
A1309.6	–	9.60	0.3780	87.0	168.0	MK 1
A1309.7	–	9.70	0.3819	87.0	168.0	MK 1
A1309.75	–	9.75	0.3839	87.0	168.0	MK 1
A1309.8	–	9.80	0.3858	87.0	168.0	MK 1



Product	DC	DC	DC	LCF	OAL	CZC MS
	[inch]	[mm]	[inch]	[mm]	[mm]	
A1309.9	–	9.90	0.3898	87.0	168.0	MK 1
A13025/64	25/64	9.92	0.3906	87.0	168.0	MK 1
A13010.0	–	10.00	0.3937	87.0	168.0	MK 1
A13010.1	–	10.10	0.3976	87.0	168.0	MK 1
A13010.2	–	10.20	0.4016	87.0	168.0	MK 1
A13010.25	–	10.25	0.4035	87.0	168.0	MK 1
A13010.3	–	10.30	0.4055	87.0	168.0	MK 1
A13013/32	13/32	10.32	0.4063	87.0	168.0	MK 1
A13010.5	–	10.50	0.4134	87.0	168.0	MK 1
A13027/64	27/64	10.72	0.4219	94.0	175.0	MK 1
A13010.75	–	10.75	0.4232	94.0	175.0	MK 1
A13010.8	–	10.80	0.4252	94.0	175.0	MK 1
A13010.9	–	10.90	0.4291	94.0	175.0	MK 1
A13011.0	–	11.00	0.4331	94.0	175.0	MK 1
A13011.1	–	11.10	0.4370	94.0	175.0	MK 1
A1307/16	7/16	11.11	0.4375	94.0	175.0	MK 1
A13011.2	–	11.20	0.4409	94.0	175.0	MK 1
A13011.25	–	11.25	0.4429	94.0	175.0	MK 1
A13011.3	–	11.30	0.4449	94.0	175.0	MK 1
A13011.4	–	11.40	0.4488	94.0	175.0	MK 1
A13011.5	–	11.50	0.4528	94.0	175.0	MK 1
A13029/64	29/64	11.51	0.4531	94.0	175.0	MK 1
A13011.6	–	11.60	0.4567	94.0	175.0	MK 1
A13011.7	–	11.70	0.4606	94.0	175.0	MK 1
A13011.75	–	11.75	0.4626	94.0	175.0	MK 1
A13011.8	–	11.80	0.4646	94.0	175.0	MK 1
A13011.9	–	11.90	0.4685	101.0	182.0	MK 1
A13015/32	15/32	11.91	0.4688	101.0	182.0	MK 1
A13012.0	–	12.00	0.4724	101.0	182.0	MK 1
A13012.1	–	12.10	0.4764	101.0	182.0	MK 1
A13012.2	–	12.20	0.4803	101.0	182.0	MK 1
A13012.25	–	12.25	0.4823	101.0	182.0	MK 1
A13031/64	31/64	12.30	0.4844	101.0	182.0	MK 1
A13012.3	–	12.30	0.4843	101.0	182.0	MK 1
A13012.4	–	12.40	0.4882	101.0	182.0	MK 1
A13012.5	–	12.50	0.4921	101.0	182.0	MK 1
A13012.6	–	12.60	0.4961	101.0	182.0	MK 1
A13012.7	–	12.70	0.5000	101.0	182.0	MK 1
A1301/2	1/2	12.70	0.5000	101.0	182.0	MK 1
A13012.75	–	12.75	0.5020	101.0	182.0	MK 1
A13012.8	–	12.80	0.5039	101.0	182.0	MK 1
A13012.9	–	12.90	0.5079	101.0	182.0	MK 1
A13013.0	–	13.00	0.5118	101.0	182.0	MK 1
A13033/64	33/64	13.10	0.5156	101.0	182.0	MK 1
A13013.2	–	13.20	0.5197	101.0	182.0	MK 1
A13013.25	–	13.25	0.5217	108.0	189.0	MK 1
A13017/32	17/32	13.49	0.5313	108.0	189.0	MK 1
A13013.5	–	13.50	0.5315	108.0	189.0	MK 1
A13013.6	–	13.60	0.5354	108.0	189.0	MK 1
A13013.7	–	13.70	0.5394	108.0	189.0	MK 1
A13013.75	–	13.75	0.5413	108.0	189.0	MK 1
A13013.8	–	13.80	0.5433	108.0	189.0	MK 1
A13035/64	35/64	13.89	0.5469	108.0	189.0	MK 1
A13013.9	–	13.90	0.5472	108.0	189.0	MK 1
A13014.0	–	14.00	0.5512	108.0	189.0	MK 1
A13014.1	–	14.10	0.5551	114.0	212.0	MK 2
A13014.2	–	14.20	0.5591	114.0	212.0	MK 2
A13014.25	–	14.25	0.5610	114.0	212.0	MK 2
A1309/16	9/16	14.29	0.5625	114.0	212.0	MK 2
A13014.3	–	14.30	0.5630	114.0	212.0	MK 2
A13014.4	–	14.40	0.5669	114.0	212.0	MK 2
A13014.5	–	14.50	0.5709	114.0	212.0	MK 2



Product	DC	DC	DC	LCF	OAL	CZC MS
	[inch]	[mm]	[inch]	[mm]	[mm]	
A13014.6	–	14.60	0.5748	114.0	212.0	MK 2
A13037/64	37/64	14.68	0.5781	114.0	212.0	MK 2
A13014.7	–	14.70	0.5787	114.0	212.0	MK 2
A13014.75	–	14.75	0.5807	114.0	212.0	MK 2
A13014.8	–	14.80	0.5827	114.0	212.0	MK 2
A13014.9	–	14.90	0.5866	114.0	212.0	MK 2
A13015.0	–	15.00	0.5906	114.0	212.0	MK 2
A13019/32	19/32	15.08	0.5938	120.0	218.0	MK 2
A13015.1	–	15.10	0.5945	120.0	218.0	MK 2
A13015.2	–	15.20	0.5984	120.0	218.0	MK 2
A13015.25	–	15.25	0.6004	120.0	218.0	MK 2
A13039/64	39/64	15.48	0.6094	120.0	218.0	MK 2
A13015.5	–	15.50	0.6102	120.0	218.0	MK 2
A13015.7	–	15.70	0.6181	120.0	218.0	MK 2
A13015.75	–	15.75	0.6201	120.0	218.0	MK 2
A13015.8	–	15.80	0.6220	120.0	218.0	MK 2
A1305/8	5/8	15.88	0.6250	120.0	218.0	MK 2
A13015.9	–	15.90	0.6260	120.0	218.0	MK 2
A13016.0	–	16.00	0.6299	120.0	218.0	MK 2
A13016.1	–	16.10	0.6339	125.0	223.0	MK 2
A13016.2	–	16.20	0.6378	125.0	223.0	MK 2
A13016.25	–	16.25	0.6398	125.0	223.0	MK 2
A13041/64	41/64	16.27	0.6406	125.0	223.0	MK 2
A13016.5	–	16.50	0.6496	125.0	223.0	MK 2
A13021/32	21/32	16.67	0.6563	125.0	223.0	MK 2
A13016.75	–	16.75	0.6594	125.0	223.0	MK 2
A13017.0	–	17.00	0.6693	125.0	223.0	MK 2
A13043/64	43/64	17.07	0.6719	130.0	228.0	MK 2
A13017.25	–	17.25	0.6791	130.0	228.0	MK 2
A13011/16	11/16	17.46	0.6875	130.0	228.0	MK 2
A13017.5	–	17.50	0.6890	130.0	228.0	MK 2
A13017.75	–	17.75	0.6988	130.0	228.0	MK 2
A13045/64	45/64	17.86	0.7031	130.0	228.0	MK 2
A13018.0	–	18.00	0.7087	130.0	228.0	MK 2
A13018.25	–	18.25	0.7185	135.0	233.0	MK 2
A13023/32	23/32	18.26	0.7188	135.0	233.0	MK 2
A13018.5	–	18.50	0.7283	135.0	233.0	MK 2
A13047/64	47/64	18.65	0.7344	135.0	233.0	MK 2
A13018.75	–	18.75	0.7382	135.0	233.0	MK 2
A13019.0	–	19.00	0.7480	135.0	233.0	MK 2
A1303/4	3/4	19.05	0.7500	140.0	238.0	MK 2
A13019.25	–	19.25	0.7579	140.0	238.0	MK 2
A13049/64	49/64	19.45	0.7656	140.0	238.0	MK 2
A13019.5	–	19.50	0.7677	140.0	238.0	MK 2
A13019.75	–	19.75	0.7776	140.0	238.0	MK 2
A13025/32	25/32	19.84	0.7813	140.0	238.0	MK 2
A13020.0	–	20.00	0.7874	140.0	238.0	MK 2
A13051/64	51/64	20.24	0.7969	145.0	243.0	MK 2
A13020.25	–	20.25	0.7972	145.0	243.0	MK 2
A13020.4	–	20.40	0.8031	145.0	243.0	MK 2
A13020.5	–	20.50	0.8071	145.0	243.0	MK 2
A13013/16	13/16	20.64	0.8125	145.0	243.0	MK 2
A13020.75	–	20.75	0.8169	145.0	243.0	MK 2
A13021.0	–	21.00	0.8268	145.0	243.0	MK 2
A13053/64	53/64	21.03	0.8281	145.0	243.0	MK 2
A13021.25	–	21.25	0.8366	150.0	248.0	MK 2
A13027/32	27/32	21.43	0.8437	150.0	248.0	MK 2
A13021.5	–	21.50	0.8465	150.0	248.0	MK 2
A13021.75	–	21.75	0.8563	150.0	248.0	MK 2
A13055/64	55/64	21.83	0.8594	150.0	248.0	MK 2
A13022.0	–	22.00	0.8661	150.0	248.0	MK 2
A1307/8	7/8	22.22	0.8750	150.0	248.0	MK 2



Product	DC	DC	DC	LCF	OAL	CZC MS
	[inch]	[mm]	[inch]	[mm]	[mm]	
A13022.25	—	22.25	0.8760	150.0	248.0	MK 2
A13022.5	—	22.50	0.8858	155.0	253.0	MK 2
A13057/64	57/64	22.62	0.8906	155.0	253.0	MK 2
A13022.75	—	22.75	0.8957	155.0	253.0	MK 2
A13023.0	—	23.00	0.9055	155.0	253.0	MK 2
A13029/32	29/32	23.02	0.9063	155.0	253.0	MK 2
A13023.25	—	23.25	0.9154	155.0	276.0	MK 3
A13059/64	59/64	23.42	0.9219	155.0	276.0	MK 3
A13023.5	—	23.50	0.9252	155.0	276.0	MK 3
A13023.75	—	23.75	0.9350	160.0	281.0	MK 3
A13015/16	15/16	23.81	0.9375	160.0	281.0	MK 3
A13024.0	—	24.00	0.9449	160.0	281.0	MK 3
A13061/64	61/64	24.21	0.9531	160.0	281.0	MK 3
A13024.25	—	24.25	0.9547	160.0	281.0	MK 3
A13024.5	—	24.50	0.9646	160.0	281.0	MK 3
A13031/32	31/32	24.61	0.9688	160.0	281.0	MK 3
A13024.75	—	24.75	0.9744	160.0	281.0	MK 3
A13025.0	—	25.00	0.9843	160.0	281.0	MK 3
A13063/64	63/64	25.00	0.9844	160.0	286.0	MK 3
A13025.25	—	25.25	0.9941	165.0	286.0	MK 3
A1301	1"	25.40	1.0000	165.0	286.0	MK 3
A13025.5	—	25.50	1.0039	165.0	286.0	MK 3
A13025.75	—	25.75	1.0138	165.0	286.0	MK 3
A13026.0	—	26.00	1.0236	165.0	286.0	MK 3
A13026.25	—	26.25	1.0335	165.0	286.0	MK 3
A13026.5	—	26.50	1.0433	165.0	286.0	MK 3
A13026.75	—	26.75	1.0531	170.0	291.0	MK 3
A1301.1/16	1.1/16	26.99	1.0625	170.0	291.0	MK 3
A13027.0	—	27.00	1.0630	170.0	291.0	MK 3
A13027.25	—	27.25	1.0728	170.0	291.0	MK 3
A13027.5	—	27.50	1.0827	170.0	291.0	MK 3
A13027.75	—	27.75	1.0925	170.0	291.0	MK 3
A13028.0	—	28.00	1.1024	170.0	291.0	MK 3
A13028.25	—	28.25	1.1122	175.0	296.0	MK 3
A13028.5	—	28.50	1.1220	175.0	296.0	MK 3
A1301.1/8	1.1/8	28.58	1.1250	175.0	296.0	MK 3
A13028.75	—	28.75	1.1319	175.0	296.0	MK 3
A13029.0	—	29.00	1.1417	175.0	296.0	MK 3
A13029.25	—	29.25	1.1516	175.0	296.0	MK 3
A1301.5/32	1.5/32	29.37	1.1563	175.0	296.0	MK 3
A13029.5	—	29.50	1.1614	175.0	296.0	MK 3
A13029.75	—	29.75	1.1713	175.0	296.0	MK 3
A13030.0	—	30.00	1.1811	175.0	296.0	MK 3
A1301.3/16	1.3/16	30.16	1.1875	180.0	301.0	MK 3
A13030.25	—	30.25	1.1909	180.0	301.0	MK 3
A13030.5	—	30.50	1.2008	180.0	301.0	MK 3
A13030.75	—	30.75	1.2106	180.0	301.0	MK 3
A1301.7/32	1.7/32	30.96	1.2188	180.0	301.0	MK 3
A13031.0	—	31.00	1.2205	180.0	301.0	MK 3
A13031.25	—	31.25	1.2303	180.0	301.0	MK 3
A13031.5	—	31.50	1.2402	180.0	301.0	MK 3
A13031.75	—	31.75	1.2500	185.0	306.0	MK 3
A1301.1/4	1.1/4	31.75	1.2500	185.0	306.0	MK 3
A13032.0	—	32.00	1.2598	185.0	334.0	MK 4
A13032.5	—	32.50	1.2795	185.0	334.0	MK 4
A1301.9/32	1.9/32	32.54	1.2813	185.0	334.0	MK 4
A13033.0	—	33.00	1.2992	185.0	334.0	MK 4
A1301.5/16	1.5/16	33.34	1.3125	185.0	334.0	MK 4
A13033.5	—	33.50	1.3189	185.0	334.0	MK 4
A13034.0	—	34.00	1.3386	190.0	339.0	MK 4
A1301.11/32	1.11/32	34.13	1.3438	190.0	339.0	MK 4
A13034.5	—	34.50	1.3583	190.0	339.0	MK 4



Product	DC	DC	DC	LCF	OAL	CZC MS
	[inch]	[mm]	[inch]	[mm]	[mm]	
A1301.3/8	1.3/8	34.93	1.3750	190.0	339.0	MK 4
A13035.0	–	35.00	1.3780	190.0	339.0	MK 4
A13035.5	–	35.50	1.3976	190.0	339.0	MK 4
A1301.13/32	1.13/32	35.72	1.4063	195.0	344.0	MK 4
A13036.0	–	36.00	1.4173	195.0	344.0	MK 4
A13036.5	–	36.50	1.4370	195.0	344.0	MK 4
A1301.7/16	1.7/16	36.51	1.4375	195.0	344.0	MK 4
A13037.0	–	37.00	1.4567	195.0	344.0	MK 4
A13037.5	–	37.50	1.4764	195.0	344.0	MK 4
A13038.0	–	38.00	1.4961	200.0	349.0	MK 4
A1301.1/2	1.1/2	38.10	1.5000	200.0	349.0	MK 4
A13038.5	–	38.50	1.5157	200.0	349.0	MK 4
A13039.0	–	39.00	1.5354	200.0	349.0	MK 4
A13039.5	–	39.50	1.5551	200.0	349.0	MK 4
A1301.9/16	1.9/16	39.69	1.5625	200.0	349.0	MK 4
A13040.0	–	40.00	1.5748	200.0	349.0	MK 4
A13040.5	–	40.50	1.5945	205.0	354.0	MK 4
A13041.0	–	41.00	1.6142	205.0	354.0	MK 4
A1301.5/8	1.5/8	41.28	1.6250	205.0	354.0	MK 4
A13041.5	–	41.50	1.6339	205.0	354.0	MK 4
A13042.0	–	42.00	1.6535	205.0	354.0	MK 4
A13042.5	–	42.50	1.6732	205.0	354.0	MK 4
A1301.11/16	1.11/16	42.86	1.6875	210.0	359.0	MK 4
A13043.0	–	43.00	1.6929	210.0	359.0	MK 4
A13043.5	–	43.50	1.7126	210.0	359.0	MK 4
A13044.0	–	44.00	1.7323	210.0	359.0	MK 4
A1301.3/4	1.3/4	44.45	1.7500	210.0	359.0	MK 4
A13044.5	–	44.50	1.7520	210.0	359.0	MK 4
A13045.0	–	45.00	1.7717	210.0	359.0	MK 4
A13045.5	–	45.50	1.7913	215.0	364.0	MK 4
A13046.0	–	46.00	1.8110	215.0	364.0	MK 4
A13046.5	–	46.50	1.8307	215.0	364.0	MK 4
A13047.0	–	47.00	1.8504	215.0	364.0	MK 4
A13047.5	–	47.50	1.8701	215.0	364.0	MK 4
A13048.0	–	48.00	1.8898	220.0	369.0	MK 4
A13048.5	–	48.50	1.9094	220.0	369.0	MK 4
A13049.0	–	49.00	1.9291	220.0	369.0	MK 4
A13049.5	–	49.50	1.9488	220.0	369.0	MK 4
A13050.0	–	50.00	1.9685	220.0	369.0	MK 4
A1302	2"	50.80	2.0000	225.0	374.0	MK 4



A530



HSS Taper Shank Drill, TiN Coated

A strong 118° conventional point which is easy to regrind and the robust design provides increased performance when used on conventional machines. Suitable for drilling many materials. TiN coating improves performance and extends the tool life.

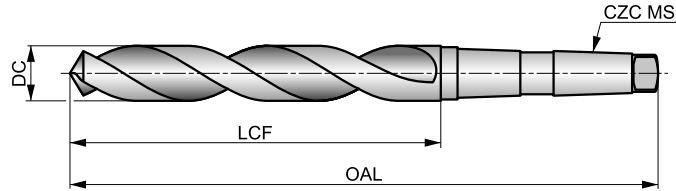

HSS	DIN 345	4xD
118°	TiN	
λ 20-35°	R	DC h8

Workpiece material group suitability, starting values for cutting speed (m/min) and feed Alpha Code. Tables with feed per revolution can be found starting from page 175.

P1.1 ■ 40 I	P1.2 ■ 45 I	P1.3 ■ 46 I	P2.1 ■ 34 I	P2.2 ■ 30 F	P2.3 ■ 27 E	P3.1 ■ 29 F	P3.2 ■ 24 F	P3.3 ■ 20 E	P4.1 ■ 18 F	P4.2 ■ 15 E	P4.3 ■ 12 D	M1.1 ■ 33 E	M1.2 ■ 28 E
M2.1 ■ 29 E	M2.2 ■ 24 E	M3.1 ■ 15 G	M3.2 ■ 13 G	M3.3 ■ 12 G	M4.1 ■ 20 C	K1.1 ■ 36 I	K1.2 ■ 27 E	K1.3 ■ 20 E	K2.1 ■ 33 E	K2.2 ■ 27 E	K2.3 ■ 22 E	K3.1 ■ 29 E	K3.2 ■ 22 E
K3.3 ■ 18 E	K4.1 ■ 27 E	K4.2 ■ 21 E	K4.3 ■ 15 E	K4.4 ■ 13 E	K4.5 ■ 11 E	K5.1 ■ 31 E	K5.2 ■ 23 E	K5.3 ■ 18 E	N1.1 ■ 55 I	N1.2 ■ 41 I	N1.3 ■ 28 I	N2.1 ■ 54 G	N2.2 ■ 48 G
N2.3 ■ 35 G	N3.1 ■ 93 G	N3.2 ■ 55 I	N3.3 ■ 28 G	N4.1 ■ 50 J	N4.2 ■ 50 H	N4.3 ■ 35 F	S1.1 ■ 32 F	S1.2 ■ 18 D	S1.3 ■ 13 B	S2.1 ■ 8 E	S2.2 ■ 4 A	S3.1 ■ 6 E	S3.2 ■ 3 A
S4.1 ■ 5 E	S4.2 ■ 2 A												

DC >= 14mm Point Thinned.

Product	DC		LCF	OAL	CZC MS
	[mm]	[inch]			
A5308.5	8.50	0.3346	75.0	156.0	MK 1
A5309.0	9.00	0.3543	81.0	162.0	MK 1
A53010.0	10.00	0.3937	87.0	168.0	MK 1
A53010.2	10.20	0.4016	87.0	168.0	MK 1
A53010.5	10.50	0.4134	87.0	168.0	MK 1
A53011.0	11.00	0.4331	94.0	175.0	MK 1
A53011.5	11.50	0.4528	94.0	175.0	MK 1
A53011.75	11.75	0.4626	94.0	175.0	MK 1
A53012.0	12.00	0.4724	101.0	182.0	MK 1
A53012.5	12.50	0.4921	101.0	182.0	MK 1
A53013.0	13.00	0.5118	101.0	182.0	MK 1
A53013.5	13.50	0.5315	108.0	189.0	MK 1
A53014.0	14.00	0.5512	108.0	189.0	MK 1
A53014.5	14.50	0.5709	114.0	212.0	MK 2
A53015.0	15.00	0.5906	114.0	212.0	MK 2
A53015.25	15.25	0.6004	120.0	218.0	MK 2
A53015.5	15.50	0.6102	120.0	218.0	MK 2
A53016.0	16.00	0.6299	120.0	218.0	MK 2
A53016.5	16.50	0.6496	125.0	223.0	MK 2
A53017.0	17.00	0.6693	125.0	223.0	MK 2
A53017.5	17.50	0.6890	130.0	228.0	MK 2
A53018.0	18.00	0.7087	130.0	228.0	MK 2
A53018.5	18.50	0.7283	135.0	233.0	MK 2
A53019.0	19.00	0.7480	135.0	233.0	MK 2
A53019.5	19.50	0.7677	140.0	238.0	MK 2
A53020.0	20.00	0.7874	140.0	238.0	MK 2

Product	DC		LCF	OAL	CZC MS
	[mm]	[inch]			
A53020.5	20.50	0.8071	145.0	243.0	MK 2
A53021.0	21.00	0.8268	145.0	243.0	MK 2
A53021.5	21.50	0.8465	150.0	248.0	MK 2
A53022.0	22.00	0.8661	150.0	248.0	MK 2
A53022.5	22.50	0.8858	155.0	253.0	MK 2
A53023.0	23.00	0.9055	155.0	253.0	MK 2
A53023.5	23.50	0.9252	155.0	276.0	MK 3
A53024.0	24.00	0.9449	160.0	281.0	MK 3
A53024.5	24.50	0.9646	160.0	281.0	MK 3
A53025.0	25.00	0.9843	160.0	281.0	MK 3
A53025.5	25.50	1.0039	165.0	286.0	MK 3
A53026.0	26.00	1.0236	165.0	286.0	MK 3
A53026.5	26.50	1.0433	165.0	286.0	MK 3
A53027.0	27.00	1.0630	170.0	291.0	MK 3
A53027.5	27.50	1.0827	170.0	291.0	MK 3
A53028.0	28.00	1.1024	170.0	291.0	MK 3
A53028.5	28.50	1.1220	175.0	296.0	MK 3
A53029.0	29.00	1.1417	175.0	296.0	MK 3
A53029.5	29.50	1.1614	175.0	296.0	MK 3
A53030.0	30.00	1.1811	175.0	296.0	MK 3
A53031.0	31.00	1.2205	180.0	301.0	MK 3
A53032.0	32.00	1.2598	185.0	334.0	MK 4
A53033.0	33.00	1.2992	185.0	334.0	MK 4
A53035.0	35.00	1.3780	190.0	339.0	MK 4
A53040.0	40.00	1.5748	200.0	349.0	MK 4



A730

HSS-E (8% Cobalt) Taper Shank Drill, Bronze Tempered Finish

Recommended for difficult materials and applications. The 118° point provides a strong point which is easy to regrind. Suitable for drilling many materials. The bronze finish is a thin oxide layer and it is an indication for Cobalt.

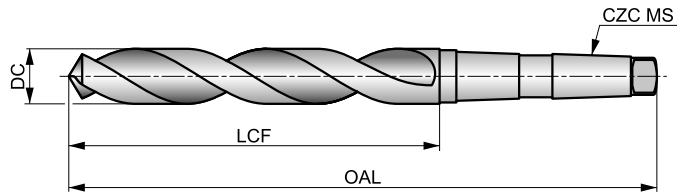

HSS-E	DIN 345	4xD
118°	Bronze	
λ 20-35°	R	DC h8

Workpiece material group suitability, starting values for cutting speed (m/min) and feed Alpha Code. Tables with feed per revolution can be found starting from page 175.

P1.1 □36 H	P1.2 □40 H	P1.3 □41 H	P2.1 □31 H	P2.2 □27 G	P2.3 ■24 E	P3.1 □25 F	P3.2 □20 F	P3.3 ■17 E	P4.1 □15 F	P4.2 ■13 E	P4.3 ■10 D	M1.1 □33 E	M1.2 □28 E
M2.1 □29 E	M2.2 □24 E	M3.1 ■13 G	M3.2 ■11 G	M3.3 ■10 G	M4.1 ■17 C	K1.1 □35 J	K1.2 □26 G	K1.3 □19 G	K2.1 □27 E	K2.2 □22 E	K2.3 ■18 E	K3.1 □24 E	K3.2 □18 E
K3.3 ■15 E	K4.1 □22 E	K4.2 □17 E	K4.3 ■12 E	K4.4 ■11 E	K4.5 ■9 E	K5.1 □25 E	K5.2 □19 E	K5.3 ■15 E	N1.1 □33 J	N1.2 □25 J	N1.3 □17 I	N2.1 □46 H	N2.2 □42 H
N2.3 □30 H	N3.1 □68 H	N3.2 □40 J	N3.3 □20 L	N4.1 □35 K	N4.2 □28 J	N4.3 □20 H	S1.1 □28 G	S1.2 □20 D	S1.3 □11 C	S2.1 □9 E	S2.2 □8 B	S3.1 □7 E	S3.2 □6 B
S4.1 □5 E	S4.2 □5 B												

DC >= 14mm Point Thinned.

Product	DC	DC	LCF	OAL	CZC MS	Product	DC	DC	LCF	OAL	CZC MS
	[mm]	[inch]					[mm]	[mm]			
A73010.0	10.00	0.3937	87.0	168.0	MK 1	A73016.25	16.25	0.6398	120.0	218.0	MK 2
A73010.2	10.20	0.4016	87.0	168.0	MK 1	A73016.5	16.50	0.6496	125.0	223.0	MK 2
A73010.5	10.50	0.4134	87.0	168.0	MK 1	A73017.0	17.00	0.6693	125.0	223.0	MK 2
A73010.8	10.80	0.4252	94.0	175.0	MK 1	A73017.25	17.25	0.6791	130.0	228.0	MK 2
A73011.0	11.00	0.4331	94.0	175.0	MK 1	A73017.5	17.50	0.6890	130.0	228.0	MK 2
A73011.5	11.50	0.4528	94.0	175.0	MK 1	A73017.75	17.75	0.6988	130.0	228.0	MK 2
A73011.8	11.80	0.4646	94.0	175.0	MK 1	A73018.0	18.00	0.7087	130.0	228.0	MK 2
A73012.0	12.00	0.4724	101.0	182.0	MK 1	A73018.25	18.25	0.7185	135.0	233.0	MK 2
A73012.2	12.20	0.4803	101.0	182.0	MK 1	A73018.5	18.50	0.7283	135.0	233.0	MK 2
A73012.5	12.50	0.4921	101.0	182.0	MK 1	A73018.75	18.75	0.7382	135.0	233.0	MK 2
A73012.8	12.80	0.5039	101.0	182.0	MK 1	A73019.0	19.00	0.7480	135.0	233.0	MK 2
A73013.0	13.00	0.5118	101.0	182.0	MK 1	A73019.25	19.25	0.7579	140.0	238.0	MK 2
A73013.5	13.50	0.5315	108.0	189.0	MK 1	A73019.5	19.50	0.7677	140.0	238.0	MK 2
A73013.8	13.80	0.5433	108.0	189.0	MK 1	A73019.75	19.75	0.7776	140.0	238.0	MK 2
A73014.0	14.00	0.5512	108.0	189.0	MK 1	A73020.0	20.00	0.7874	140.0	238.0	MK 2
A73014.25	14.25	0.5610	114.0	212.0	MK 2	A73020.25	20.25	0.7972	145.0	243.0	MK 2
A73014.5	14.50	0.5709	114.0	212.0	MK 2	A73020.5	20.50	0.8071	145.0	243.0	MK 2
A73014.75	14.75	0.5807	114.0	212.0	MK 2	A73020.75	20.75	0.8169	145.0	243.0	MK 2
A73015.0	15.00	0.5906	114.0	212.0	MK 2	A73021.0	21.00	0.8268	145.0	243.0	MK 2
A73015.25	15.25	0.6004	120.0	218.0	MK 2	A73021.5	21.50	0.8465	150.0	248.0	MK 2
A73015.5	15.50	0.6102	120.0	218.0	MK 2	A73022.0	22.00	0.8661	150.0	248.0	MK 2
A73015.75	15.75	0.6201	120.0	218.0	MK 2	A73022.5	22.50	0.8858	155.0	253.0	MK 2
A73016.0	16.00	0.6299	120.0	218.0	MK 2	A73023.0	23.00	0.9055	155.0	253.0	MK 2



Product	DC	DC	LCF	OAL	CZC MS
	[mm]	[inch]	[mm]	[mm]	
A73023.5	23.50	0.9252	155.0	276.0	MK 3
A73024.0	24.00	0.9449	160.0	281.0	MK 3
A73024.5	24.50	0.9646	160.0	281.0	MK 3
A73025.0	25.00	0.9843	160.0	281.0	MK 3
A73025.5	25.50	1.0039	165.0	286.0	MK 3
A73026.0	26.00	1.0236	165.0	286.0	MK 3
A73026.5	26.50	1.0433	165.0	286.0	MK 3
A73027.0	27.00	1.0630	170.0	291.0	MK 3

Product	DC	DC	LCF	OAL	CZC MS
	[mm]	[inch]	[mm]	[mm]	
A73027.5	27.50	1.0827	170.0	291.0	MK 3
A73028.0	28.00	1.1024	170.0	291.0	MK 3
A73028.5	28.50	1.1220	175.0	296.0	MK 3
A73029.0	29.00	1.1417	175.0	296.0	MK 3
A73030.0	30.00	1.1811	175.0	296.0	MK 3
A73031.0	31.00	1.2205	180.0	301.0	MK 3
A73032.0	32.00	1.2598	185.0	334.0	MK 4



A166



HSS Taper Shank Drill, Steam Tempered Finish, with Brazed Carbide Point

Brazed carbide tip gives the high performance of a carbide drill with a strong and less brittle HSS body. It has a 118°, four-facet point which helps with self-centering and is easy to regrind, making it an economical choice when drilling cast iron materials.

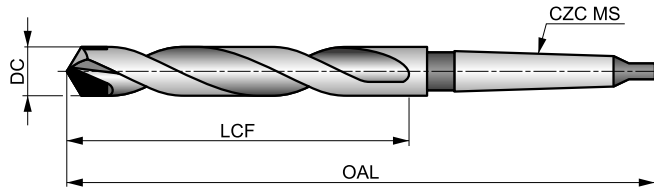

HSS HM	DIN 345	4×D
118°	Bright ST	
20-35°	R	DC h8

Workpiece material group suitability, starting values for cutting speed (m/min) and feed Alpha Code. Tables with feed per revolution can be found starting from page 175.

P1.1 ▣73 E	P1.2 ▣82 E	P1.3 ▣85 E	P2.1 ▣63 E	P2.2 ▣55 D	P2.3 ▣49 C	P3.1 ▣59 D	P3.2 ▣47 D	P3.3 ▣40 C	P4.1 ▣35 D	P4.2 ▣30 C	P4.3 ▣24 A	M1.1 ▣55 B	M1.2 ▣46 B
M2.1 ▣49 B	M2.2 ▣40 B	M3.1 ▣41 C	M3.2 ▣35 C	M3.3 ▣32 C	M4.1 ▣35 A	K1.1 ▣50 C	K1.2 ▣37 C	K1.3 ▣28 C	K2.1 ▣43 C	K2.2 ▣35 C	K2.3 ▣28 A	K3.1 ▣38 C	K3.2 ▣29 C
K3.3 ▣24 A	K4.1 ▣35 C	K4.2 ▣27 C	K4.3 ▣20 A	K4.4 ▣17 A	K4.5 ▣14 A	K5.1 ▣40 C	K5.2 ▣30 C	K5.3 ▣23 A	N1.1 ▣50 I	N1.2 ▣38 I	N1.3 ▣25 H	N2.1 ▣62 G	N2.2 ▣55 G
N2.3 ▣40 G	N3.1 ▣127 C	N3.2 ▣75 G	N3.3 ▣38 D	N4.2 ▣60 E	S1.1 ▣35 A	S1.2 ▣35 A	S1.3 ▣25 A	S2.1 ▣33 A	S2.2 ▣28 A	S3.1 ▣25 A	S3.2 ▣20 A	S4.1 ▣20 A	S4.2 ▣16 A

Product	DC	DC	LCF	OAL	CZC MS	Product	DC	DC	LCF	OAL	CZC MS
	[mm]	[inch]					[mm]	[mm]			
A16610.0	10.00	0.3937	87.0	168.0	MK 1	A16620.0	20.00	0.7874	140.0	238.0	MK 2
A16610.5	10.50	0.4134	87.0	168.0	MK 1	A16621.0	21.00	0.8268	145.0	243.0	MK 2
A16611.0	11.00	0.4331	94.0	175.0	MK 1	A16622.0	22.00	0.8661	150.0	248.0	MK 2
A16611.5	11.50	0.4528	94.0	175.0	MK 1	A16622.5	22.50	0.8858	155.0	253.0	MK 2
A16612.0	12.00	0.4724	101.0	182.0	MK 1	A16623.0	23.00	0.9055	155.0	253.0	MK 2
A16613.0	13.00	0.5118	101.0	182.0	MK 1	A16624.0	24.00	0.9449	160.0	281.0	MK 3
A16613.5	13.50	0.5315	108.0	189.0	MK 1	A16625.0	25.00	0.9843	160.0	281.0	MK 3
A16614.0	14.00	0.5512	108.0	189.0	MK 1	A16626.0	26.00	1.0236	165.0	286.0	MK 3
A16615.0	15.00	0.5906	114.0	212.0	MK 2	A16627.0	27.00	1.0630	170.0	291.0	MK 3
A16616.0	16.00	0.6299	120.0	218.0	MK 2	A16628.0	28.00	1.1024	170.0	291.0	MK 3
A16617.0	17.00	0.6693	125.0	223.0	MK 2	A16629.0	29.00	1.1417	175.0	296.0	MK 3
A16617.5	17.50	0.6890	130.0	228.0	MK 2	A16630.0	30.00	1.1811	175.0	296.0	MK 3
A16618.0	18.00	0.7087	130.0	228.0	MK 2	A16632.0	32.00	1.2598	185.0	334.0	MK 4
A16619.0	19.00	0.7480	135.0	233.0	MK 2	A16633.0	33.00	1.2992	185.0	334.0	MK 4



A350



HSS Long Series Taper Shank Drill, Steam Tempered Finish

Recommended for drilling deep holes or for applications where increased reach is required. Steam tempered finish retains cutting fluid and prevents chip to tool welding. A 118° point angle is easy to regrind and provides strength. Suitable for drilling many materials.

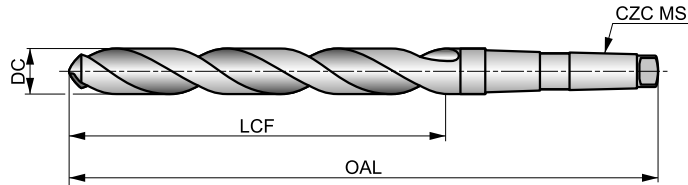

HSS	DIN 341	6xD
118°	ST	
λ 20-35°	R	DC h8

Workpiece material group suitability, starting values for cutting speed (m/min) and feed Alpha Code. Tables with feed per revolution can be found starting from page 175.

P1.1 ■ 27 I	P1.2 ■ 30 I	P1.3 ■ 31 I	P2.1 ■ 23 I	P2.2 ■ 20 G	P2.3 ■ 18 E	P3.1 ■ 15 F	P3.2 ■ 12 F	P3.3 ■ 10 E	P4.1 ■ 9 F	P4.2 ■ 7 E	P4.3 ■ 6 D	M1.1 ■ 18 E	M1.2 ■ 15 E
M2.1 ■ 16 E	M2.2 ■ 13 E	M3.1 ■ 5 G	M3.2 ■ 4 G	M3.3 ■ 4 G	M4.1 ■ 8 C	K1.1 ■ 26 I	K1.2 ■ 19 F	K1.3 ■ 14 F	K2.1 ■ 22 E	K2.2 ■ 18 E	K2.3 ■ 14 E	K3.1 ■ 20 E	K3.2 ■ 15 E
K3.3 ■ 12 E	K4.1 ■ 18 E	K4.2 ■ 14 E	K4.3 ■ 10 E	K4.4 ■ 9 E	K4.5 ■ 7 E	K5.1 ■ 21 E	K5.2 ■ 15 E	K5.3 ■ 12 E	N1.1 ■ 33 J	N1.2 ■ 25 J	N1.3 ■ 17 I	N2.1 ■ 42 H	N2.2 ■ 37 H
N2.3 ■ 27 H	N3.1 ■ 59 H	N3.2 ■ 35 I	N3.3 ■ 18 F	N4.1 ■ 35 L	N4.2 ■ 26 J	N4.3 ■ 12 H	S1.1 ■ 16 F	S1.2 ■ 9 D	S1.3 ■ 5 B	S2.1 ■ 5 E	S2.2 ■ 4 A	S3.1 ■ 4 E	S3.2 ■ 3 A
S4.1 ■ 3 E	S4.2 ■ 2 A												

Product	DC	DC	LCF	OAL	CZC MS
	[mm]	[inch]			
A3505.0	5.00	0.1969	74.0	155.0	MK 1
A3505.5	5.50	0.2165	80.0	161.0	MK 1
A3506.0	6.00	0.2362	80.0	161.0	MK 1
A3506.7	6.70	0.2638	86.0	167.0	MK 1
A3506.8	6.80	0.2677	93.0	174.0	MK 1
A3507.0	7.00	0.2756	93.0	174.0	MK 1
A3507.5	7.50	0.2953	93.0	174.0	MK 1
A3508.0	8.00	0.3150	100.0	181.0	MK 1
A3508.4	8.40	0.3307	100.0	181.0	MK 1
A3508.5	8.50	0.3346	100.0	181.0	MK 1
A3508.75	8.75	0.3445	107.0	188.0	MK 1
A3509.0	9.00	0.3543	107.0	188.0	MK 1
A3509.5	9.50	0.3740	107.0	188.0	MK 1
A3509.8	9.80	0.3858	116.0	197.0	MK 1
A35010.0	10.00	0.3937	116.0	197.0	MK 1
A35010.2	10.20	0.4016	116.0	197.0	MK 1
A35010.5	10.50	0.4134	116.0	197.0	MK 1
A35010.7	10.70	0.4213	125.0	206.0	MK 1
A35011.0	11.00	0.4331	125.0	206.0	MK 1
A35011.5	11.50	0.4528	125.0	206.0	MK 1
A35011.75	11.75	0.4626	125.0	206.0	MK 1
A35011.8	11.80	0.4646	125.0	206.0	MK 1
A35012.0	12.00	0.4724	134.0	215.0	MK 1
A35012.5	12.50	0.4921	134.0	215.0	MK 1

Product	DC	DC	LCF	OAL	CZC MS
	[mm]	[inch]			
A35013.0	13.00	0.5118	134.0	215.0	MK 1
A35013.5	13.50	0.5315	142.0	223.0	MK 1
A35014.0	14.00	0.5512	142.0	223.0	MK 1
A35014.25	14.25	0.5610	147.0	245.0	MK 2
A35014.5	14.50	0.5709	147.0	245.0	MK 2
A35014.75	14.75	0.5807	147.0	245.0	MK 2
A35015.0	15.00	0.5906	147.0	245.0	MK 2
A35015.25	15.25	0.6004	153.0	251.0	MK 2
A35015.5	15.50	0.6102	153.0	251.0	MK 2
A35015.75	15.75	0.6201	153.0	251.0	MK 2
A35016.0	16.00	0.6299	153.0	251.0	MK 2
A35016.25	16.25	0.6398	159.0	257.0	MK 2
A35016.5	16.50	0.6496	159.0	257.0	MK 2
A35016.75	16.75	0.6594	159.0	257.0	MK 2
A35017.0	17.00	0.6693	159.0	257.0	MK 2
A35017.25	17.25	0.6791	165.0	263.0	MK 2
A35017.5	17.50	0.6890	165.0	263.0	MK 2
A35018.0	18.00	0.7087	165.0	263.0	MK 2
A35018.5	18.50	0.7283	171.0	269.0	MK 2
A35019.0	19.00	0.7480	171.0	269.0	MK 2
A35019.5	19.50	0.7677	177.0	275.0	MK 2
A35019.75	19.75	0.7776	177.0	275.0	MK 2
A35020.0	20.00	0.7874	177.0	275.0	MK 2
A35020.25	20.25	0.7972	184.0	282.0	MK 2



Product	DC	DC	LCF	OAL	CZC MS
	[mm]	[inch]	[mm]	[mm]	
A35020.5	20.50	0.8071	184.0	282.0	MK 2
A35021.0	21.00	0.8268	184.0	282.0	MK 2
A35021.5	21.50	0.8465	191.0	289.0	MK 2
A35022.0	22.00	0.8661	191.0	289.0	MK 2
A35022.5	22.50	0.8858	198.0	296.0	MK 2
A35023.0	23.00	0.9055	198.0	296.0	MK 2
A35023.5	23.50	0.9252	198.0	319.0	MK 3
A35024.0	24.00	0.9449	206.0	327.0	MK 3
A35024.5	24.50	0.9646	206.0	327.0	MK 3
A35025.0	25.00	0.9843	206.0	327.0	MK 3
A35025.5	25.50	1.0039	214.0	335.0	MK 3
A35026.0	26.00	1.0236	214.0	335.0	MK 3
A35026.5	26.50	1.0433	214.0	335.0	MK 3
A35027.0	27.00	1.0630	222.0	343.0	MK 3
A35027.5	27.50	1.0827	222.0	343.0	MK 3
A35028.0	28.00	1.1024	222.0	343.0	MK 3
A35029.0	29.00	1.1417	230.0	351.0	MK 3
A35030.0	30.00	1.1811	230.0	351.0	MK 3
A35030.5	30.50	1.2008	239.0	360.0	MK 3
A35031.0	31.00	1.2205	239.0	360.0	MK 3

Product	DC	DC	LCF	OAL	CZC MS
	[mm]	[inch]	[mm]	[mm]	
A35031.5	31.50	1.2402	239.0	360.0	MK 3
A35032.0	32.00	1.2598	248.0	397.0	MK 4
A35033.0	33.00	1.2992	248.0	397.0	MK 4
A35034.0	34.00	1.3386	257.0	406.0	MK 4
A35035.0	35.00	1.3780	257.0	406.0	MK 4
A35036.0	36.00	1.4173	267.0	416.0	MK 4
A35037.0	37.00	1.4567	267.0	416.0	MK 4
A35038.0	38.00	1.4961	277.0	426.0	MK 4
A35039.0	39.00	1.5354	277.0	426.0	MK 4
A35040.0	40.00	1.5748	277.0	426.0	MK 4
A35041.0	41.00	1.6142	287.0	436.0	MK 4
A35042.0	42.00	1.6535	287.0	436.0	MK 4
A35043.0	43.00	1.6929	298.0	447.0	MK 4
A35044.0	44.00	1.7323	298.0	447.0	MK 4
A35045.0	45.00	1.7717	298.0	447.0	MK 4
A35046.0	46.00	1.8110	310.0	459.0	MK 4
A35047.0	47.00	1.8504	310.0	459.0	MK 4
A35048.0	48.00	1.8898	321.0	470.0	MK 4
A35050.0	50.00	1.9685	321.0	470.0	MK 4



A345



HSS Long Series Taper Shank Drill (DIN 1870 Series 1), Steam Tempered Finish

Recommended for drilling very deep holes or for applications where increased reach is required. A 118° point angle is easy to regrind and provides strength. Steam tempered finish retains cutting fluid and prevents chip to tool welding. Suitable for drilling many materials.

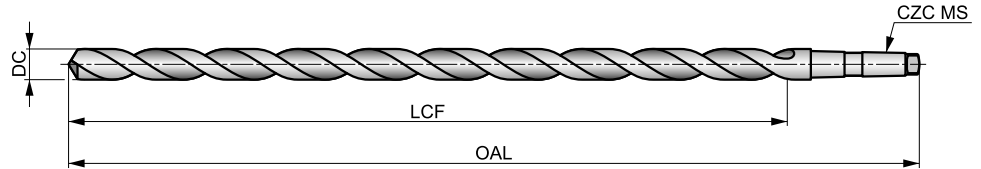

HSS	DIN 1870(1)	10xD
118°	ST	
λ 20-35°	R	DC h8

Workpiece material group suitability, starting values for cutting speed (m/min) and feed Alpha Code. Tables with feed per revolution can be found starting from page 175.

P1.1 ■ 23 G	P1.2 ■ 25 G	P1.3 ■ 26 G	P2.1 ■ 19 G	P2.2 ■ 17 E	P2.3 ■ 15 C	P3.1 ■ 9 D	P3.2 ■ 7 D	P3.3 ■ 6 C	P4.1 ■ 5 D	P4.2 ■ 4 C	P4.3 ■ 4 B	M1.1 ■ 16 C	M1.2 ■ 14 C
M2.1 ■ 15 C	M2.2 ■ 12 C	M3.1 ■ 5 E	M3.2 ■ 4 E	M3.3 ■ 4 E	M4.1 ■ 8 A	K1.1 ■ 22 G	K1.2 ■ 16 D	K1.3 ■ 12 D	K2.1 ■ 16 C	K2.2 ■ 13 C	K2.3 ■ 10 C	K3.1 ■ 14 C	K3.2 ■ 11 C
K3.3 ■ 9 C	K4.1 ■ 13 C	K4.2 ■ 10 C	K4.3 ■ 7 C	K4.4 ■ 6 C	K4.5 ■ 5 C	K5.1 ■ 15 C	K5.2 ■ 11 C	K5.3 ■ 9 C	N1.1 ■ 33 H	N1.2 ■ 25 H	N1.3 ■ 17 G	N2.1 ■ 42 F	N2.2 ■ 37 F
N2.3 ■ 27 F	N3.1 ■ 56 F	N3.2 ■ 33 G	N3.3 ■ 17 D	N4.1 ■ 30 J	N4.2 ■ 30 H	N4.3 ■ 10 F	S1.1 ■ 15 D	S1.2 ■ 9 B	S1.3 ■ 5 A	S2.1 ■ 5 C	S2.2 ■ 4 A	S3.1 ■ 4 C	S3.2 ■ 3 A
S4.1 ■ 3 C	S4.2 ■ 2 A												

DC > 25.4mm less than 10xD.

Product	DC	DC	DC	LCF	OAL	CZC MS
	[inch]	[mm]	[inch]	[mm]	[mm]	
A3458.0	–	8.00	0.3150	165.0	265.0	MK 1
A3458.5	–	8.50	0.3346	165.0	265.0	MK 1
A3459.0	–	9.00	0.3543	175.0	275.0	MK 1
A3459.5	–	9.50	0.3740	175.0	275.0	MK 1
A3453/8	3/8	9.52	0.3750	185.0	285.0	MK 1
A34510.0	–	10.00	0.3937	185.0	285.0	MK 1
A34513/32	13/32	10.32	0.4063	185.0	285.0	MK 1
A34510.5	–	10.50	0.4134	185.0	285.0	MK 1
A34511.0	–	11.00	0.4331	195.0	300.0	MK 1
A3457/16	7/16	11.11	0.4375	195.0	300.0	MK 1
A34511.5	–	11.50	0.4528	195.0	300.0	MK 1
A34529/64	29/64	11.51	0.4531	205.0	310.0	MK 1
A34512.0	–	12.00	0.4724	205.0	310.0	MK 1
A34512.5	–	12.50	0.4921	205.0	310.0	MK 1
A3451/2	1/2	12.70	0.5000	205.0	310.0	MK 1
A34513.0	–	13.00	0.5118	205.0	310.0	MK 1
A34517/32	17/32	13.49	0.5313	220.0	325.0	MK 1
A34513.5	–	13.50	0.5315	220.0	325.0	MK 1
A34514.0	–	14.00	0.5512	220.0	325.0	MK 1
A3459/16	9/16	14.29	0.5625	220.0	340.0	MK 2
A34537/64	37/64	14.68	0.5781	220.0	340.0	MK 2
A34515.0	–	15.00	0.5906	220.0	340.0	MK 2
A34539/64	39/64	15.48	0.6094	230.0	355.0	MK 2

Product	DC	DC	DC	LCF	OAL	CZC MS
	[inch]	[mm]	[inch]	[mm]	[mm]	
A34515.5	–	15.50	0.6102	230.0	355.0	MK 2
A3455/8	5/8	15.88	0.6250	230.0	355.0	MK 2
A34516.0	–	16.00	0.6299	230.0	355.0	MK 2
A34541/64	41/64	16.27	0.6406	230.0	355.0	MK 2
A34516.5	–	16.50	0.6496	230.0	355.0	MK 2
A34521/32	21/32	16.67	0.6563	230.0	355.0	MK 2
A34517.0	–	17.00	0.6693	230.0	355.0	MK 2
A34511/16	11/16	17.46	0.6875	245.0	370.0	MK 2
A34517.5	–	17.50	0.6890	245.0	370.0	MK 2
A34518.0	–	18.00	0.7087	245.0	370.0	MK 2
A34518.5	–	18.50	0.7283	245.0	370.0	MK 2
A34519.0	–	19.00	0.7480	245.0	370.0	MK 2
A3453/4	3/4	19.05	0.7500	260.0	385.0	MK 2
A34519.5	–	19.50	0.7677	260.0	385.0	MK 2
A34520.0	–	20.00	0.7874	260.0	385.0	MK 2
A34520.5	–	20.50	0.8071	260.0	385.0	MK 2
A34521.0	–	21.00	0.8268	260.0	385.0	MK 2
A34521.5	–	21.50	0.8465	270.0	405.0	MK 2
A34522.0	–	22.00	0.8661	270.0	405.0	MK 2
A3457/8	7/8	22.22	0.8750	270.0	405.0	MK 2
A34522.5	–	22.50	0.8858	270.0	405.0	MK 3
A34523.0	–	23.00	0.9055	270.0	405.0	MK 3
A34523.5	–	23.50	0.9252	270.0	425.0	MK 3



Product	DC	DC	DC	LCF	OAL	CZC MS
	[inch]	[mm]	[inch]	[mm]	[mm]	
A34524.0	–	24.00	0.9449	290.0	440.0	MK 3
A34524.5	–	24.50	0.9646	290.0	440.0	MK 3
A34525.0	–	25.00	0.9843	290.0	440.0	MK 3
A3451	1"	25.40	1.0000	290.0	440.0	MK 3
A34525.5	–	25.50	1.0039	290.0	440.0	MK 3
A34526.0	–	26.00	1.0236	290.0	440.0	MK 3
A34526.5	–	26.50	1.0433	290.0	440.0	MK 3
A34527.0	–	27.00	1.0630	305.0	460.0	MK 3
A34528.0	–	28.00	1.1024	305.0	460.0	MK 3
A34529.0	–	29.00	1.1417	305.0	460.0	MK 3
A34530.0	–	30.00	1.1811	305.0	460.0	MK 3
A3451.1/4	1.1/4	31.75	1.2500	320.0	480.0	MK 3

Product	DC	DC	DC	LCF	OAL	CZC MS
	[inch]	[mm]	[inch]	[mm]	[mm]	
A34531.0	–	31.00	1.2205	320.0	480.0	MK 3
A34532.0	–	32.00	1.2598	320.0	505.0	MK 4
A34533.0	–	33.00	1.2992	320.0	505.0	MK 4
A34534.0	–	34.00	1.3386	340.0	530.0	MK 4
A34535.0	–	35.00	1.3780	340.0	530.0	MK 4
A34536.0	–	36.00	1.4173	340.0	530.0	MK 4
A34537.0	–	37.00	1.4567	340.0	530.0	MK 4
A34538.0	–	38.00	1.4961	360.0	555.0	MK 4
A3451.1/2	1.1/2	38.10	1.5000	360.0	555.0	MK 4
A34539.0	–	39.00	1.5354	360.0	555.0	MK 4
A34540.0	–	40.00	1.5748	360.0	555.0	MK 4



A951



HSS PFX Extra Long Series Taper Shank Drill (DIN 1870 Series 1), Bright Finish

A versatile drill with a special parabolic flute design for drilling deep holes in a single pass. The drill has a self-centering 130° point (centering with a short PFX Drill is recommended) so the force needed to drill the hole is reduced. Suitable for drilling many materials.

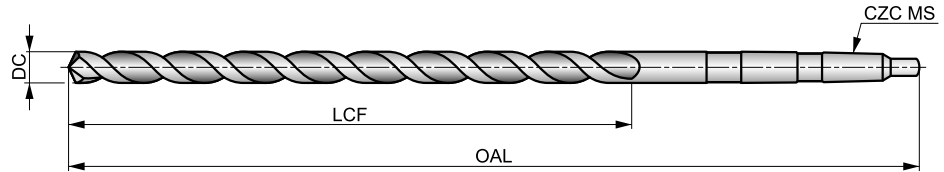

HSS	DIN 1870(1)	15×D
130°	Bright ST	
λ > 35°	R	DC h8

Workpiece material group suitability, starting values for cutting speed (m/min) and feed Alpha Code. Tables with feed per revolution can be found starting from page 175.

P1.1 ■ 25 G	P1.2 ■ 28 G	P1.3 ■ 29 G	P2.1 ■ 22 G	P2.2 ■ 19 E	P2.3 ■ 17 C	P3.1 ■ 12 D	P3.2 ■ 9 D	P3.3 ■ 8 C	P4.1 ■ 7 D	P4.2 ■ 6 C	P4.3 ■ 5 B	M1.1 ■ 16 C	M1.2 ■ 14 C
M2.1 ■ 15 C	M2.2 ■ 12 C	M3.1 ■ 7 E	M3.2 ■ 6 E	M3.3 ■ 5 E	M4.1 ■ 12 A	K1.1 ■ 22 G	K1.2 ■ 16 D	K1.3 ■ 12 D	K2.1 ■ 16 C	K2.2 ■ 13 C	K2.3 ■ 10 C	K3.1 ■ 14 C	K3.2 ■ 11 C
K3.3 ■ 9 C	K4.1 ■ 13 C	K4.2 ■ 10 C	K4.3 ■ 7 C	K4.4 ■ 6 C	K4.5 ■ 5 C	K5.1 ■ 15 C	K5.2 ■ 11 C	K5.3 ■ 9 C	N1.1 ■ 30 H	N1.2 ■ 23 H	N1.3 ■ 15 G	N2.1 ■ 37 F	N2.2 ■ 33 F
N2.3 ■ 24 F	N3.1 ■ 56 F	N3.2 ■ 33 G	N3.3 ■ 17 D	N4.1 ■ 30 J	N4.2 ■ 30 H	N4.3 ■ 10 F	S1.1 ■ 18 D	S1.2 ■ 10 B	S1.3 ■ 6 A	S2.1 ■ 7 C	S2.2 ■ 4 A	S3.1 ■ 5 C	S3.2 ■ 3 A
S4.1 ■ 4 C	S4.2 ■ 2 A												

DC >= 14.5mm less than 15xD; DC > 23mm Bright.

Product	DC	DC	LCF	OAL	CZC MS
	[mm]	[inch]			
A95110.0	10.00	0.3937	185.0	285.0	MK 1
A95111.0	11.00	0.4331	195.0	300.0	MK 1
A95112.0	12.00	0.4724	205.0	310.0	MK 1
A95112.5	12.50	0.4921	205.0	310.0	MK 1
A95113.0	13.00	0.5118	205.0	310.0	MK 1
A95113.5	13.50	0.5315	220.0	325.0	MK 1
A95114.0	14.00	0.5512	220.0	325.0	MK 1
A95114.5	14.50	0.5709	220.0	340.0	MK 2
A95115.0	15.00	0.5906	220.0	340.0	MK 2
A95115.5	15.50	0.6102	230.0	355.0	MK 2
A95116.0	16.00	0.6299	230.0	355.0	MK 2
A95116.5	16.50	0.6496	230.0	355.0	MK 2
A95117.0	17.00	0.6693	230.0	355.0	MK 2
A95117.5	17.50	0.6890	245.0	370.0	MK 2
A95118.0	18.00	0.7087	245.0	370.0	MK 2

Product	DC	DC	LCF	OAL	CZC MS
	[mm]	[inch]			
A95118.5	18.50	0.7283	245.0	370.0	MK 2
A95119.0	19.00	0.7480	245.0	370.0	MK 2
A95119.5	19.50	0.7677	260.0	385.0	MK 2
A95120.0	20.00	0.7874	260.0	385.0	MK 2
A95121.0	21.00	0.8268	260.0	385.0	MK 2
A95122.0	22.00	0.8661	270.0	405.0	MK 2
A95123.0	23.00	0.9055	270.0	405.0	MK 2
A95124.0	24.00	0.9449	290.0	440.0	MK 3
A95125.0	25.00	0.9843	290.0	440.0	MK 3
A95126.0	26.00	1.0236	290.0	440.0	MK 3
A95127.0	27.00	1.0630	305.0	460.0	MK 3
A95128.0	28.00	1.1024	305.0	460.0	MK 3
A95129.0	29.00	1.1417	305.0	460.0	MK 3
A95130.0	30.00	1.1811	305.0	460.0	MK 3



A952



HSS PFX Extra Long Series Taper Shank Drill (DIN 1870 Series 2), Bright Finish

A versatile drill with a special parabolic flute design for drilling deep holes in a single pass. The drill has a self-centering 130° point (centering with a short PFX Drill is recommended) so the force needed to drill the hole is reduced. Suitable for drilling many materials.

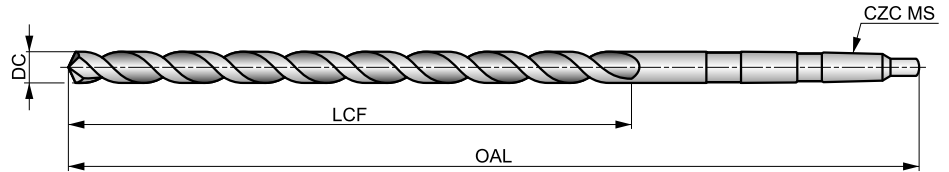

HSS	DIN 1870(2)	20xD
130°	Bright ST	
$\lambda > 35^\circ$	R	DC h8

Workpiece material group suitability, starting values for cutting speed (m/min) and feed Alpha Code. Tables with feed per revolution can be found starting from page 175.

P1.1 ■ 25 G	P1.2 ■ 28 G	P1.3 ■ 29 G	P2.1 ■ 22 G	P2.2 ■ 19 E	P2.3 ■ 17 C	P3.1 ■ 12 D	P3.2 ■ 9 D	P3.3 ■ 8 C	P4.1 ■ 7 D	P4.2 ■ 6 C	P4.3 ■ 5 B	M1.1 ■ 16 C	M1.2 ■ 14 C
M2.1 ■ 15 C	M2.2 ■ 12 C	M3.1 ■ 17 E	M3.2 ■ 16 E	M3.3 ■ 5 E	M4.1 ■ 12 A	K1.1 ■ 22 G	K1.2 ■ 16 D	K1.3 ■ 12 D	K2.1 ■ 16 C	K2.2 ■ 13 C	K2.3 ■ 10 C	K3.1 ■ 14 C	K3.2 ■ 11 C
K3.3 ■ 9 C	K4.1 ■ 13 C	K4.2 ■ 10 C	K4.3 ■ 7 C	K4.4 ■ 6 C	K4.5 ■ 5 C	K5.1 ■ 15 C	K5.2 ■ 11 C	K5.3 ■ 9 C	N1.1 ■ 30 H	N1.2 ■ 23 H	N1.3 ■ 15 G	N2.1 ■ 37 F	N2.2 ■ 33 F
N2.3 ■ 24 F	N3.1 ■ 56 F	N3.2 ■ 33 G	N3.3 ■ 17 D	N4.1 ■ 30 J	N4.2 ■ 30 H	N4.3 ■ 10 F	S1.1 ■ 18 D	S1.2 ■ 10 B	S1.3 ■ 6 A	S2.1 ■ 7 C	S2.2 ■ 4 A	S3.1 ■ 5 C	S3.2 ■ 3 A
S4.1 ■ 4 C	S4.2 ■ 2 A												

DC >= 14.5mm less than 20xD; DC > 23mm Bright.

Product	DC [mm]	DC [inch]	LCF [mm]	OAL [mm]	CZC MS	Product	DC [mm]	DC [inch]	LCF [mm]	OAL [mm]	CZC MS
A9528.0	8.00	0.3150	210.0	330.0	MK 1	A95219.0	19.00	0.7480	310.0	465.0	MK 2
A9528.5	8.50	0.3346	210.0	330.0	MK 1	A95219.5	19.50	0.7677	325.0	490.0	MK 2
A9529.0	9.00	0.3543	220.0	345.0	MK 1	A95220.0	20.00	0.7874	325.0	490.0	MK 2
A95210.0	10.00	0.3937	235.0	360.0	MK 1	A95221.0	21.00	0.8268	325.0	490.0	MK 2
A95210.5	10.50	0.4134	235.0	360.0	MK 1	A95222.0	22.00	0.8661	345.0	515.0	MK 2
A95211.0	11.00	0.4331	250.0	375.0	MK 1	A95223.0	23.00	0.9055	345.0	515.0	MK 2
A95211.5	11.50	0.4528	250.0	375.0	MK 1	A95224.0	24.00	0.9449	365.0	555.0	MK 3
A95212.0	12.00	0.4724	260.0	395.0	MK 1	A95225.0	25.00	0.9843	365.0	555.0	MK 3
A95212.5	12.50	0.4921	260.0	395.0	MK 1	A95226.0	26.00	1.0236	365.0	555.0	MK 3
A95213.0	13.00	0.5118	260.0	395.0	MK 1	A95227.0	27.00	1.0630	385.0	580.0	MK 3
A95213.5	13.50	0.5315	275.0	410.0	MK 1	A95228.0	28.00	1.1024	385.0	580.0	MK 3
A95214.0	14.00	0.5512	275.0	410.0	MK 1	A95229.0	29.00	1.1417	385.0	580.0	MK 3
A95214.5	14.50	0.5709	275.0	425.0	MK 2	A95230.0	30.00	1.1811	385.0	580.0	MK 3
A95215.0	15.00	0.5906	275.0	425.0	MK 2	A95231.0	31.00	1.2205	410.0	610.0	MK 3
A95215.5	15.50	0.6102	295.0	445.0	MK 2	A95232.0	32.00	1.2598	410.0	635.0	MK 4
A95216.0	16.00	0.6299	295.0	445.0	MK 2	A95233.0	33.00	1.2992	410.0	635.0	MK 4
A95216.5	16.50	0.6496	295.0	445.0	MK 2	A95234.0	34.00	1.3386	430.0	665.0	MK 4
A95217.0	17.00	0.6693	295.0	445.0	MK 2	A95235.0	35.00	1.3780	430.0	665.0	MK 4
A95217.5	17.50	0.6890	310.0	465.0	MK 2	A95238.0	38.00	1.4961	460.0	695.0	MK 4
A95218.0	18.00	0.7087	310.0	465.0	MK 2	A95240.0	40.00	1.5748	460.0	695.0	MK 4
A95218.5	18.50	0.7283	310.0	465.0	MK 2						



A400



HSS Subland Drill, Steam Tempered Finish

A versatile tool, designed to drill chamfered clearance holes for standard metric screws. A 118° point angle on the drill Pilot and a 90° Countersink. Suitable for both CNC and conventional machines. Steam tempered finish retains cutting fluid and prevents chip to tool welding. Suitable for drilling many materials.

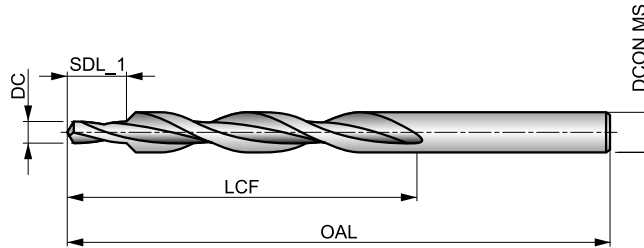

HSS	DIN 8374	4xD
90°	ST	
λ 20-35°	R	118°

Workpiece material group suitability, starting values for cutting speed (m/min) and feed Alpha Code. Tables with feed per revolution can be found starting from page 175.

P1.1 ■ 29 G	P1.2 ■ 33 G	P1.3 ■ 34 G	P2.1 ■ 25 G	P2.2 ■ 22 E	P2.3 ■ 19 C	P3.1 ■ 15 E	P3.2 ■ 12 E	P3.3 ■ 10 C	P4.1 ■ 9 E	P4.2 ■ 7 C	P4.3 ■ 6 C	M1.1 ■ 22 E	M1.2 ■ 19 E
M2.1 ■ 20 E	M2.2 ■ 16 E	M3.1 ■ 10 G	M3.2 ■ 9 G	M3.3 ■ 8 G	M4.1 ■ 12 C	K1.1 ■ 30 G	K1.2 ■ 22 E	K1.3 ■ 17 E	K2.1 ■ 23 E	K2.2 ■ 19 E	K2.3 ■ 15 C	K3.1 ■ 21 E	K3.2 ■ 16 E
K3.3 ■ 13 C	K4.1 ■ 19 E	K4.2 ■ 14 E	K4.3 ■ 11 C	K4.4 ■ 9 C	K4.5 ■ 8 C	K5.1 ■ 22 E	K5.2 ■ 16 E	K5.3 ■ 13 C	N1.1 ■ 45 E	N1.2 ■ 34 E	N1.3 ■ 23 E	N2.1 ■ 49 E	N2.2 ■ 44 E
N2.3 ■ 32 E	N3.1 ■ 68 E	N3.2 ■ 40 E	N3.3 ■ 20 E	N4.1 ■ 30 I	S1.1 ■ 23 E	S1.2 ■ 14 C	S1.3 ■ 8 A	S2.1 ■ 8 C	S2.2 ■ 6 A	S3.1 ■ 6 C	S3.2 ■ 4 A	S4.1 ■ 5 C	S4.2 ■ 3 A

Product	TDZ	DC	DC	LCF	OAL	SDL_1	DCON MS
		[mm]	[inch]				
A400M3	M3	3.20	0.1260	57.0	93.0	9.00	6.00
A400M4	M4	4.30	0.1693	75.0	117.0	11.00	8.00
A400M5	M5	5.30	0.2087	87.0	133.0	13.00	10.00
A400M6	M6	6.40	0.2520	94.0	142.0	15.00	11.50
A400M8	M8	8.40	0.3307	114.0	169.0	19.00	15.00
A400M10	M10	10.50	0.4134	135.0	198.0	23.00	19.00



A402



HSS Subland Drill, Steam Tempered Finish

Includes a 118° Pilot and 180° counterbore with specific Pilot diameter and length, recommended for creating counterbored clearance holes for standard metric screws. Steam tempered finish retains cutting fluid and prevents chip to tool welding. Suitable for drilling many materials.

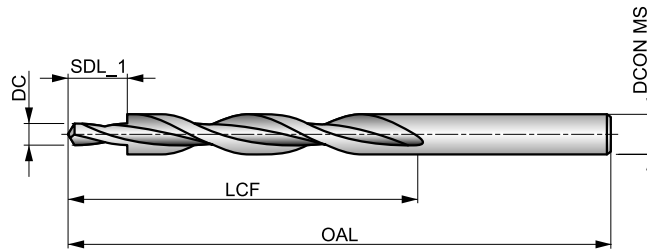

HSS	DIN 8376	4×D
180°	ST	
20-35°	R	118°

Workpiece material group suitability, starting values for cutting speed (m/min) and feed Alpha Code. Tables with feed per revolution can be found starting from page 175.

P1.1 ■ 29 G	P1.2 ■ 33 G	P1.3 ■ 34 G	P2.1 ■ 25 G	P2.2 ■ 22 E	P2.3 ■ 19 C	P3.1 ■ 15 E	P3.2 ■ 12 E	P3.3 ■ 10 C	P4.1 ■ 9 E	P4.2 ■ 17 C	P4.3 ■ 16 C	M1.1 ■ 22 E	M1.2 ■ 19 E
M2.1 ■ 20 E	M2.2 ■ 16 E	M3.1 ■ 10 G	M3.2 ■ 9 G	M3.3 ■ 8 G	M4.1 ■ 12 C	K1.1 ■ 30 G	K1.2 ■ 22 E	K1.3 ■ 17 E	K2.1 ■ 23 E	K2.2 ■ 19 E	K2.3 ■ 15 C	K3.1 ■ 21 E	K3.2 ■ 16 E
K3.3 ■ 13 C	K4.1 ■ 19 E	K4.2 ■ 14 E	K4.3 ■ 11 C	K4.4 ■ 9 C	K4.5 ■ 8 C	K5.1 ■ 22 E	K5.2 ■ 16 E	K5.3 ■ 13 C	N1.1 ■ 45 E	N1.2 ■ 34 E	N1.3 ■ 23 E	N2.1 ■ 49 E	N2.2 ■ 44 E
N2.3 ■ 32 E	N3.1 ■ 68 E	N3.2 ■ 40 E	N3.3 ■ 20 E	N4.1 ■ 30 I	S1.1 ■ 23 E	S1.2 ■ 14 C	S1.3 ■ 8 A	S2.1 ■ 8 C	S2.2 ■ 6 A	S3.1 ■ 6 C	S3.2 ■ 4 A	S4.1 ■ 5 C	S4.2 ■ 3 A

Product	TDZ	DC	DC	LCF	OAL	SDL_1	DCON MS
		[mm]	[inch]				
A402M3	M3	3.40	0.1339	57.0	93.0	9.00	6.00
A402M4	M4	4.50	0.1772	75.0	117.0	11.00	8.00
A402M5	M5	5.50	0.2165	87.0	133.0	13.00	10.00
A402M6	M6	6.60	0.2598	94.0	142.0	15.00	11.00
A402M8	M8	9.00	0.3543	114.0	169.0	19.00	15.00
A402M10	M10	11.00	0.4331	130.0	191.0	23.00	18.00



A405



HSS Taper Shank Subland Drill, Steam Tempered Finish

A versatile tool recommended for creating counterbored clearance holes for standard metric screws. A 118° Pilot and 180° counterbore. Suitable for both CNC and conventional machines. Steam tempered finish retains cutting fluid and prevents chip to tool welding. Suitable for drilling many materials.

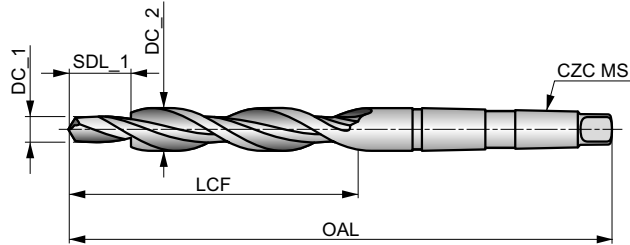

HSS	DIN 8377	4xD
180°	ST	
λ 20-35°	R	118°

Workpiece material group suitability, starting values for cutting speed (m/min) and feed Alpha Code. Tables with feed per revolution can be found starting from page 175.

P1.1 ■ 29 G	P1.2 ■ 33 G	P1.3 ■ 34 G	P2.1 ■ 25 G	P2.2 ■ 22 E	P2.3 ■ 19 C	P3.1 ■ 15 E	P3.2 ■ 12 E	P3.3 ■ 10 C	P4.1 ■ 9 E	P4.2 ■ 7 C	P4.3 ■ 6 C	M1.1 ■ 22 E	M1.2 ■ 19 E
M2.1 ■ 20 E	M2.2 ■ 16 E	M3.1 ■ 10 G	M3.2 ■ 9 G	M3.3 ■ 8 G	M4.1 ■ 12 C	K1.1 ■ 30 G	K1.2 ■ 22 E	K1.3 ■ 17 E	K2.1 ■ 23 E	K2.2 ■ 19 E	K2.3 ■ 15 C	K3.1 ■ 21 E	K3.2 ■ 16 E
K3.3 ■ 13 C	K4.1 ■ 19 E	K4.2 ■ 14 E	K4.3 ■ 11 C	K4.4 ■ 9 C	K4.5 ■ 8 C	K5.1 ■ 22 E	K5.2 ■ 16 E	K5.3 ■ 13 C	N1.1 ■ 45 E	N1.2 ■ 34 E	N1.3 ■ 23 E	N2.1 ■ 49 E	N2.2 ■ 44 E
N2.3 ■ 32 E	N3.1 ■ 68 E	N3.2 ■ 40 E	N3.3 ■ 20 E	N4.1 ■ 30 I	S1.1 ■ 23 E	S1.2 ■ 14 C	S1.3 ■ 8 A	S2.1 ■ 8 C	S2.2 ■ 6 A	S3.1 ■ 6 C	S3.2 ■ 4 A	S4.1 ■ 5 C	S4.2 ■ 3 A

Product	TDZ	DC_1	DC_1	DC_2	LCF	OAL	SDL_1	CZC MS
		[mm]	[inch]	[mm]	[mm]	[mm]	[mm]	
A405M6	M6	6.60	0.2598	11.00	94.0	175.0	15.00	MK 1
A405M8	M8	9.00	0.3543	15.00	114.0	212.0	19.00	MK 2
A405M10	M10	11.00	0.4331	18.00	130.0	228.0	23.00	MK 2
A405M12	M12	13.50	0.5315	20.00	140.0	238.0	27.00	MK 2
A405M14	M14	15.50	0.6102	24.00	160.0	281.0	31.00	MK 3
A405M16	M16	17.50	0.6890	26.00	165.0	286.0	35.00	MK 3
A405M18	M18	20.00	0.7874	30.00	175.0	296.0	39.00	MK 3



A412



HSS Step Drill, Steam Tempered Finish

Designed to drill chamfered clearance holes for standard metric screws. A 118° point angle on the drill Pilot with a 90° chamfer. Steam tempered finish retains cutting fluid and prevents chip to tool welding. Suitable for drilling many materials. It is suitable for both CNC and conventional machines.

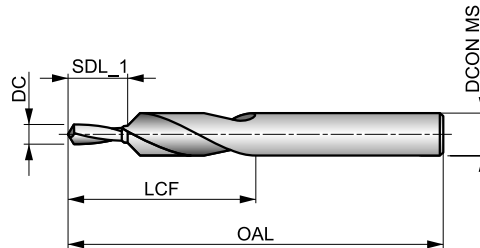

HSS	DORMER	2.5×D
90°	ST	
R	118°	

Workpiece material group suitability, starting values for cutting speed (m/min) and feed Alpha Code. Tables with feed per revolution can be found starting from page 175.

P1.1 ■ 29 I	P1.2 ■ 33 I	P1.3 ■ 34 I	P2.1 ■ 25 I	P2.2 ■ 22 G	P2.3 ▣ 19 E	P3.1 ■ 15 G	P3.2 ■ 12 G	P3.3 ▣ 10 E	P4.1 ■ 9 G	P4.2 ▣ 17 E	P4.3 ▣ 16 C	M1.1 ■ 22 G	M1.2 ■ 19 G
M2.1 ■ 20 G	M2.2 ■ 16 G	M3.1 ▣ 10 I	M3.2 ▣ 9 I	M3.3 ▣ 8 I	M4.1 ▣ 12 E	K1.1 ■ 30 G	K1.2 ■ 22 E	K1.3 ■ 17 E	K2.1 ▣ 23 E	K2.2 ▣ 19 E	K2.3 ▣ 15 E	K3.1 ▣ 21 E	K3.2 ▣ 16 E
K3.3 ▣ 13 E	K4.1 ▣ 19 E	K4.2 ▣ 14 E	K4.3 ▣ 11 E	K4.4 ▣ 9 E	K4.5 ▣ 8 E	K5.1 ▣ 22 E	K5.2 ▣ 16 E	K5.3 ▣ 13 E	N1.1 ▣ 45 G	N1.2 ▣ 34 G	N1.3 ▣ 23 G	N2.1 ▣ 42 G	N2.2 ▣ 37 G
N2.3 ▣ 27 G	N3.1 ▣ 68 G	N3.2 ▣ 40 G	N3.3 ▣ 20 G	N4.1 ▣ 30 I	S1.1 ▣ 27 G	S1.2 ▣ 16 E	S1.3 ▣ 8 C	S2.1 ▣ 11 G	S2.2 ▣ 6 C	S3.1 ▣ 8 G	S3.2 ▣ 4 C	S4.1 ▣ 6 G	S4.2 ▣ 3 C

Product	TDZ	DC	DC	LCF	OAL	SDL_1	DCON MS
		[mm]	[inch]				
A412M3	M3	3.40	0.1339	31.0	70.0	9.00	6.60
A412M4	M4	4.50	0.1772	40.0	84.0	11.00	9.00
A412M5	M5	5.50	0.2165	47.0	95.0	13.00	11.00
A412M6	M6	6.60	0.2598	51.0	102.0	15.00	13.00
A412M8	M8	9.00	0.3543	62.0	123.0	19.00	17.20
A412M10	M10	11.00	0.4331	70.0	141.0	23.00	21.50



A413



HSS Step Drill, Steam Tempered Finish

A versatile tool recommended for creating counterbored clearance holes for standard metric screws. A 118° Pilot and 180° counterbore. Steam tempered finish retains cutting fluid and prevents chip to tool welding. Suitable for both CNC and conventional machines. Suitable for drilling many materials.

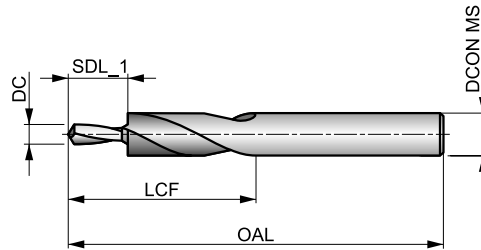

HSS	DORMER	2.5×D
180°	ST	
R	118°	

Workpiece material group suitability, starting values for cutting speed (m/min) and feed Alpha Code. Tables with feed per revolution can be found starting from page 175.

P1.1 ■ 29 I	P1.2 ■ 33 I	P1.3 ■ 34 I	P2.1 ■ 25 I	P2.2 ■ 22 G	P2.3 ■ 19 E	P3.1 ■ 15 G	P3.2 ■ 12 G	P3.3 ■ 10 E	P4.1 ■ 9 G	P4.2 ■ 7 E	P4.3 ■ 6 C	M1.1 ■ 22 G	M1.2 ■ 19 G
M2.1 ■ 20 G	M2.2 ■ 16 G	M3.1 ■ 10 I	M3.2 ■ 9 I	M3.3 ■ 8 I	M4.1 ■ 12 E	K1.1 ■ 30 G	K1.2 ■ 22 E	K1.3 ■ 17 E	K2.1 ■ 23 E	K2.2 ■ 19 E	K2.3 ■ 15 E	K3.1 ■ 21 E	K3.2 ■ 16 E
K3.3 ■ 13 E	K4.1 ■ 19 E	K4.2 ■ 14 E	K4.3 ■ 11 E	K4.4 ■ 9 E	K4.5 ■ 8 E	K5.1 ■ 22 E	K5.2 ■ 16 E	K5.3 ■ 13 E	N1.1 ■ 45 G	N1.2 ■ 34 G	N1.3 ■ 23 G	N2.1 ■ 42 G	N2.2 ■ 37 G
N2.3 ■ 27 G	N3.1 ■ 68 G	N3.2 ■ 40 G	N3.3 ■ 20 G	N4.1 ■ 30 I	S1.1 ■ 27 G	S1.2 ■ 16 E	S1.3 ■ 8 C	S2.1 ■ 11 G	S2.2 ■ 6 C	S3.1 ■ 8 G	S3.2 ■ 4 C	S4.1 ■ 6 G	S4.2 ■ 3 C

Product	TDZ	DC	DC	LCF	OAL	SDL_1	DCON MS
		[mm]	[inch]				
A413M3	M3	3.40	0.1339	28.0	66.0	9.00	6.00
A413M4	M4	4.50	0.1772	37.0	79.0	11.00	8.00
A413M5	M5	5.50	0.2165	43.0	89.0	13.00	10.00
A413M6	M6	6.60	0.2598	47.0	95.0	15.00	11.00
A413M8	M8	9.00	0.3543	56.0	111.0	19.00	15.00
A413M10	M10	11.00	0.4331	62.0	123.0	23.00	18.00



A200



HSS Centre Drill with 118° Point angle and 60° Countersink, Bright Finish

Recommended for starting a precise hole in the end of a shaft so it can be securely held prior to machining. The two drilling ends give increased productivity per tool. Suitable for many materials.

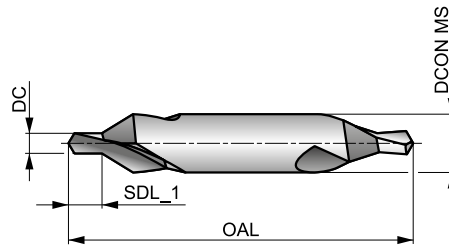
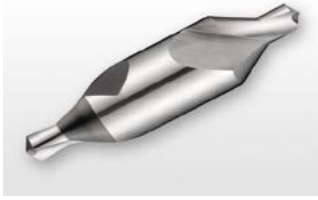

HSS	DIN 333A	1×D
60°	Bright	
R	118°	

Workpiece material group suitability, starting values for cutting speed (m/min) and feed Alpha Code. Tables with feed per revolution can be found starting from page 175.

P1.1 ■ 33 I	P1.2 ■ 37 I	P1.3 ■ 38 I	P2.1 ■ 28 I	P2.2 ■ 25 G	P2.3 ■ 22 E	P3.1 ■ 19 F	P3.2 ■ 15 F	P3.3 ■ 13 E	P4.1 ■ 11 F	P4.2 ■ 10 E	P4.3 ■ 8 D	M1.1 ■ 21 E	M1.2 ■ 17 E
M2.1 ■ 18 E	M2.2 ■ 15 E	M3.1 ■ 9 G	M3.2 ■ 8 G	M3.3 ■ 7 G	M4.1 ■ 10 C	K1.1 ■ 30 I	K1.2 ■ 22 F	K1.3 ■ 17 F	K2.1 ■ 25 E	K2.2 ■ 20 E	K2.3 ■ 16 E	K3.1 ■ 22 E	K3.2 ■ 17 E
K3.3 ■ 13 E	K4.1 ■ 20 E	K4.2 ■ 15 E	K4.3 ■ 11 E	K4.4 ■ 10 E	K4.5 ■ 8 E	K5.1 ■ 23 E	K5.2 ■ 17 E	K5.3 ■ 13 E	N1.1 ■ 33 J	N1.2 ■ 25 J	N1.3 ■ 17 I	N2.1 ■ 42 H	N2.2 ■ 37 H
N2.3 ■ 27 H	N3.1 ■ 56 H	N3.2 ■ 33 I	N3.3 ■ 17 G	N4.1 ■ 30 J	N4.2 ■ 28 H	N4.3 ■ 14 F	S1.1 ■ 24 F	S1.2 ■ 13 D	S1.3 ■ 7 B	S2.1 ■ 7 E	S2.2 ■ 6 A	S3.1 ■ 5 E	S3.2 ■ 4 A
S4.1 ■ 4 E	S4.2 ■ 3 A												

Products from this series are also available in set. Please see A296.

Product	DC	DC	SDL_1	OAL	DCON MS
	[mm]	[inch]	[mm]	[mm]	[mm]
A200.5X3.15 ¹⁾	0.50	0.0197	0.9 - 0.6	25.0	3.15
A200.8X3.15 ¹⁾	0.80	0.0315	1.3 - 1.0	25.0	3.15
A2001.0X3.15	1.00	0.0394	1.7 - 1.3	31.0	3.15
A2001.25X3.15	1.25	0.0492	2.0 - 1.6	31.0	3.15
A2001.6X4.0	1.60	0.0630	2.6 - 2.0	35.0	4.00
A2002.0X5.0	2.00	0.0787	3.1 - 2.5	40.0	5.00
A2002.5X6.3	2.50	0.0984	3.8 - 3.1	45.0	6.30
A2003.15X8.0	3.15	0.1240	4.6 - 3.9	50.0	8.00
A2004.0X10.0	4.00	0.1575	5.9 - 5.0	55.0	10.00
A2005.0X12.5	5.00	0.1969	7.2 - 6.3	63.0	12.50
A2006.3X16.0	6.30	0.2480	8.9 - 8.0	71.0	16.00
A2008.0X20.0	8.00	0.3150	11.1 - 10.1	80.0	20.00
A20010.0X25.0	10.00	0.3937	13.8 - 12.8	100.0	25.00
A20012.5X31.5	12.50	0.4921	17.5 - 16.5	125.0	31.50

¹⁾ Single Ended Only.



A205



HSS Centre Drill with 118° Point angle and 60° Countersink, TiN Coated

Recommended for starting a precise hole in the end of a shaft so it can be securely held prior to machining. The two drilling ends give increased productivity per tool. TiN coating improves performance and extends tool life. Suitable for drilling many materials.

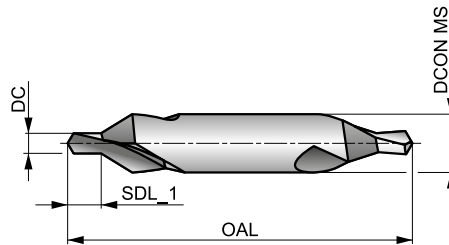
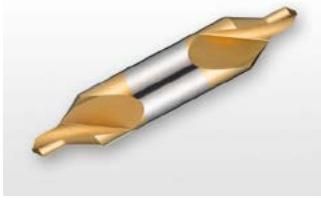

HSS	DIN 333A	1xD
60°	TiN	
R	118°	

Workpiece material group suitability, starting values for cutting speed (m/min) and feed Alpha Code. Tables with feed per revolution can be found starting from page 175.

P1.1 ■ 40 I	P1.2 ■ 45 I	P1.3 ■ 46 I	P2.1 ■ 34 I	P2.2 ■ 30 G	P2.3 ■ 27 E	P3.1 ■ 24 F	P3.2 ■ 19 F	P3.3 ■ 16 E	P4.1 ■ 14 F	P4.2 ■ 12 E	P4.3 ■ 10 D	M1.1 ■ 25 E	M1.2 ■ 21 E
M2.1 ■ 22 E	M2.2 ■ 18 E	M3.1 ■ 12 G	M3.2 ■ 10 G	M3.3 ■ 9 G	M4.1 ■ 12 C	K1.1 ■ 36 I	K1.2 ■ 27 F	K1.3 ■ 20 F	K2.1 ■ 30 E	K2.2 ■ 24 E	K2.3 ■ 19 E	K3.1 ■ 26 E	K3.2 ■ 20 E
K3.3 ■ 16 E	K4.1 ■ 24 E	K4.2 ■ 18 E	K4.3 ■ 13 E	K4.4 ■ 11 E	K4.5 ■ 10 E	K5.1 ■ 27 E	K5.2 ■ 21 E	K5.3 ■ 16 E	N1.1 ■ 40 J	N1.2 ■ 30 J	N1.3 ■ 20 I	N2.1 ■ 49 H	N2.2 ■ 44 H
N2.3 ■ 32 H	N3.1 ■ 68 H	N3.2 ■ 40 I	N3.3 ■ 20 G	N4.1 ■ 36 J	N4.2 ■ 34 H	N4.3 ■ 17 F	S1.1 ■ 29 F	S1.2 ■ 16 D	S1.3 ■ 8 B	S2.1 ■ 8 E	S2.2 ■ 7 A	S3.1 ■ 6 E	S3.2 ■ 5 A
S4.1 ■ 5 E	S4.2 ■ 4 A												

Product	DC	DC	SDL_1	OAL	DCON MS
	[mm]	[inch]			
A2051.0X3.15	1.00	0.0394	1.7 - 1.3	31.0	3.15
A2051.25X3.15	1.25	0.0492	2.0 - 1.6	31.0	3.15
A2051.6X4.0	1.60	0.0630	2.6 - 2.0	35.0	4.00
A2052.0X5.0	2.00	0.0787	3.1 - 2.5	40.0	5.00
A2052.5X6.3	2.50	0.0984	3.8 - 3.1	45.0	6.30
A2053.15X8.0	3.15	0.1240	4.6 - 3.9	50.0	8.00
A2054.0X10.0	4.00	0.1575	5.9 - 5.0	55.0	10.00
A2055.0X12.5	5.00	0.1969	7.2 - 6.3	63.0	12.50



A206



HSS-E Centre Drill with 118° Point angle and 60° Countersink, Bright Finish

Recommended for starting a precise hole in the end of a shaft so it can be securely held prior to machining. The two drilling ends give increased productivity per tool. Suitable for drilling many materials.

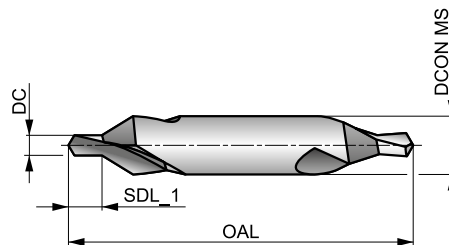
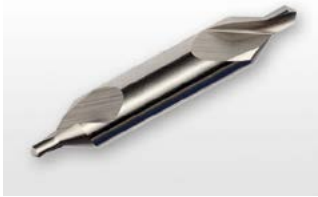

HSS-E	DIN 333A	1×D
60°	Bright	
R	118°	

Workpiece material group suitability, starting values for cutting speed (m/min) and feed Alpha Code. Tables with feed per revolution can be found starting from page 175.

P1.1 ■ 40 I	P1.2 ■ 45 I	P1.3 ■ 46 I	P2.1 ■ 34 I	P2.2 ■ 30 G	P2.3 ■ 27 E	P3.1 ■ 24 F	P3.2 ■ 19 F	P3.3 ■ 16 E	P4.1 ■ 14 F	P4.2 ■ 12 E	P4.3 ■ 10 D	M1.1 ■ 25 E	M1.2 ■ 21 E
M2.1 ■ 22 E	M2.2 ■ 18 E	M3.1 ■ 12 G	M3.2 ■ 10 G	M3.3 ■ 9 G	M4.1 ■ 12 C	K1.1 ■ 36 I	K1.2 ■ 27 F	K1.3 ■ 20 F	K2.1 ■ 30 E	K2.2 ■ 24 E	K2.3 ■ 19 E	K3.1 ■ 26 E	K3.2 ■ 20 E
K3.3 ■ 16 E	K4.1 ■ 24 E	K4.2 ■ 18 E	K4.3 ■ 13 E	K4.4 ■ 11 E	K4.5 ■ 10 E	K5.1 ■ 27 E	K5.2 ■ 21 E	K5.3 ■ 16 E	N1.1 ■ 40 J	N1.2 ■ 30 J	N1.3 ■ 20 I	N2.1 ■ 49 H	N2.2 ■ 44 H
N2.3 ■ 32 H	N3.1 ■ 68 H	N3.2 ■ 40 I	N3.3 ■ 20 G	N4.1 ■ 36 J	N4.2 ■ 34 H	N4.3 ■ 17 F	S1.1 ■ 29 F	S1.2 ■ 16 D	S1.3 ■ 8 B	S2.1 ■ 8 E	S2.2 ■ 7 A	S3.1 ■ 6 E	S3.2 ■ 5 A
S4.1 ■ 5 E	S4.2 ■ 4 A												

Product	DC	DC	SDL_1	OAL	DCON MS
	[mm]	[inch]			
A2061.0X3.15	1.00	0.0394	1.7 - 1.3	31.0	3.15
A2061.25X3.15	1.25	0.0492	2.0 - 1.6	31.0	3.15
A2061.6X4.0	1.60	0.0630	2.6 - 2.0	35.0	4.00
A2062.0X5.0	2.00	0.0787	3.1 - 2.5	40.0	5.00
A2062.5X6.3	2.50	0.0984	3.8 - 3.1	45.0	6.30
A2063.15X8.0	3.15	0.1240	4.6 - 3.9	50.0	8.00
A2064.0X10.0	4.00	0.1575	5.9 - 5.0	55.0	10.00
A2065.0X12.5	5.00	0.1969	7.2 - 6.3	63.0	12.50



A266



HSS-E Centre Drill with 118° Pilot and 60° Countersink, TiAlN Coated

Recommended for starting a precise hole in the end of a shaft so it can be securely held prior to machining. The two drilling ends give increased productivity per tool. TiAlN coating improves performance and extends tool life. Suitable for drilling many materials.

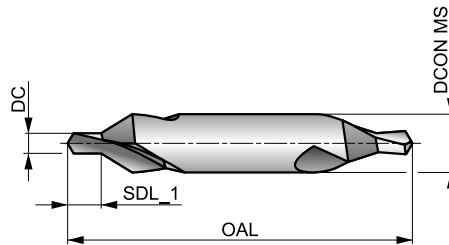

HSS-E	DIN 333A	1xD
60°	TiAlN	
R	118°	

Workpiece material group suitability, starting values for cutting speed (m/min) and feed Alpha Code. Tables with feed per revolution can be found starting from page 175.

P1.1 ■ 40 I	P1.2 ■ 45 I	P1.3 ■ 46 I	P2.1 ■ 34 I	P2.2 ■ 30 G	P2.3 ■ 27 E	P3.1 ■ 24 F	P3.2 ■ 19 F	P3.3 ■ 16 E	P4.1 ■ 14 F	P4.2 ■ 12 E	P4.3 ■ 10 D	M1.1 ■ 25 E	M1.2 ■ 21 E
M2.1 ■ 22 E	M2.2 ■ 18 E	M3.1 ■ 12 G	M3.2 ■ 10 G	M3.3 ■ 9 G	M4.1 ■ 12 C	K1.1 ■ 36 I	K1.2 ■ 27 F	K1.3 ■ 20 F	K2.1 ■ 30 E	K2.2 ■ 24 E	K2.3 ■ 19 E	K3.1 ■ 26 E	K3.2 ■ 20 E
K3.3 ■ 16 E	K4.1 ■ 24 E	K4.2 ■ 18 E	K4.3 ■ 13 E	K4.4 ■ 11 E	K4.5 ■ 10 E	K5.1 ■ 27 E	K5.2 ■ 21 E	K5.3 ■ 16 E	N1.1 ■ 40 J	N1.2 ■ 30 J	N1.3 ■ 20 I	N2.1 ■ 49 H	N2.2 ■ 44 H
N2.3 ■ 32 H	N3.1 ■ 68 H	N3.2 ■ 40 I	N3.3 ■ 20 G	N4.1 ■ 36 J	N4.2 ■ 34 H	N4.3 ■ 17 F	S1.1 ■ 29 F	S1.2 ■ 16 D	S1.3 ■ 8 B	S2.1 ■ 8 E	S2.2 ■ 7 A	S3.1 ■ 6 E	S3.2 ■ 5 A
S4.1 ■ 5 E	S4.2 ■ 4 A												

Product	DC	DC	SDL_1	OAL	DCON MS
	[mm]	[inch]	[mm]	[mm]	[mm]
A2661.0X3.15	1.00	0.0394	1.7 - 1.3	31.0	3.15
A2661.25X3.15	1.25	0.0492	2.0 - 1.6	31.0	3.15
A2661.6X4.0	1.60	0.0630	2.6 - 2.0	35.0	4.00
A2662.0X5.0	2.00	0.0787	3.1 - 2.5	40.0	5.00
A2662.5X6.3	2.50	0.0984	3.8 - 3.1	45.0	6.30
A2663.15X8.0	3.15	0.1240	4.6 - 3.9	50.0	8.00
A2664.0X10.0	4.00	0.1575	5.9 - 5.0	55.0	10.00
A2665.0X12.5	5.00	0.1969	7.2 - 6.3	63.0	12.50



A210

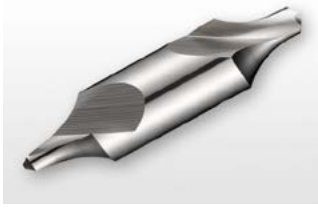

HSS Center Drill, 118° Point angle and Concave Countersink, Bright Finish

Recommended for starting a precise hole in the end of a shaft so it can be securely held prior to machining. The two drilling ends give increased productivity per tool. Can be used to machine a number of materials.

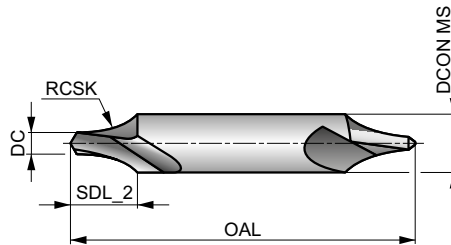

HSS	DIN 333R	1×D
R	Bright	
R	118°	

Workpiece material group suitability, starting values for cutting speed (m/min) and feed Alpha Code. Tables with feed per revolution can be found starting from page 175.

P1.1 ■ 33 I	P1.2 ■ 37 I	P1.3 ■ 38 I	P2.1 ■ 28 I	P2.2 ■ 25 G	P2.3 ■ 22 E	P3.1 ■ 19 F	P3.2 ■ 15 F	P3.3 ■ 13 E	P4.1 ■ 11 F	P4.2 ■ 10 E	P4.3 ■ 8 D	M1.1 ■ 21 E	M1.2 ■ 17 E
M2.1 ■ 18 E	M2.2 ■ 15 E	M3.1 ■ 9 G	M3.2 ■ 8 G	M3.3 ■ 7 G	M4.1 ■ 10 C	K1.1 ■ 30 I	K1.2 ■ 22 F	K1.3 ■ 17 F	K2.1 ■ 25 E	K2.2 ■ 20 E	K2.3 ■ 16 E	K3.1 ■ 22 E	K3.2 ■ 17 E
K3.3 ■ 13 E	K4.1 ■ 20 E	K4.2 ■ 15 E	K4.3 ■ 11 E	K4.4 ■ 10 E	K4.5 ■ 8 E	K5.1 ■ 23 E	K5.2 ■ 17 E	K5.3 ■ 13 E	N1.1 ■ 33 J	N1.2 ■ 25 J	N1.3 ■ 17 I	N2.1 ■ 42 H	N2.2 ■ 37 H
N2.3 ■ 27 H	N3.1 ■ 56 H	N3.2 ■ 33 I	N3.3 ■ 17 G	N4.1 ■ 30 J	N4.2 ■ 28 H	N4.3 ■ 14 F	S1.1 ■ 24 F	S1.2 ■ 13 D	S1.3 ■ 7 B	S2.1 ■ 7 E	S2.2 ■ 6 A	S3.1 ■ 5 E	S3.2 ■ 4 A
S4.1 ■ 4 E	S4.2 ■ 3 A												

Product	DC	DC	SDL_2	OAL	RCSK	DCON MS
	[mm]	[inch]	[mm]	[mm]	[mm]	[mm]
A210.5X3.15 ¹⁾	0.50	0.0197	2.6 - 2.3	25.0	2.50 - 2.00	3.15
A210.8X3.15 ¹⁾	0.80	0.0315	2.9 - 2.6	25.0	3.15 - 2.50	3.15
A2101.0X3.15	1.00	0.0394	3.3 - 3.0	31.0	3.65 - 2.90	3.15
A2101.25X3.15	1.25	0.0492	3.6 - 3.3	31.0	3.95 - 3.15	3.15
A2101.6X4.0	1.60	0.0630	4.7 - 4.2	35.0	5.00 - 4.00	4.00
A2102.0X5.0	2.00	0.0787	5.4 - 5.0	40.0	6.25 - 5.00	5.00
A2102.5X6.3	2.50	0.0984	6.8 - 6.3	45.0	7.88 - 6.30	6.30
A2103.15X8.0	3.15	0.1240	8.5 - 8.0	50.0	10.00 - 8.00	8.00
A2104.0X10.0	4.00	0.1575	10.6 - 10.0	55.0	12.50 - 10.00	10.00
A2105.0X12.5	5.00	0.1969	13.1 - 12.5	63.0	15.63 - 12.50	12.50
A2106.3X16.0	6.30	0.2480	16.6 - 16.0	71.0	20.00 - 16.00	16.00
A2108.0X20.0	8.00	0.3150	20.7 - 20.0	80.0	25.00 - 20.00	20.00
A21010.0X25.0	10.00	0.3937	25.7 - 25.0	100.0	31.25 - 25.00	25.00

¹⁾ Single Ended Only.



A201



HSS Centre Drill with 122° Point angle and 60° Countersink, Bright Finish

Recommended for starting a precise hole in the end of a shaft so it can be securely held prior to machining. The two drilling ends give increased productivity per tool. Suitable for drilling many materials.

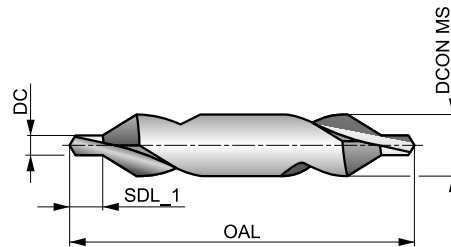

HSS	DORMER	1xD
60°	Bright	
R	122°	

Workpiece material group suitability, starting values for cutting speed (m/min) and feed Alpha Code. Tables with feed per revolution can be found starting from page 175.

P1.1 ■ 33 I	P1.2 ■ 37 I	P1.3 ■ 38 I	P2.1 ■ 28 I	P2.2 ■ 25 G	P2.3 ■ 22 E	P3.1 ■ 19 F	P3.2 ■ 15 F	P3.3 ■ 13 E	P4.1 ■ 11 F	P4.2 ■ 10 E	P4.3 ■ 8 D	M1.1 ■ 21 E	M1.2 ■ 17 E
M2.1 ■ 18 E	M2.2 ■ 15 E	M3.1 ■ 9 G	M3.2 ■ 8 G	M3.3 ■ 7 G	M4.1 ■ 10 C	K1.1 ■ 30 I	K1.2 ■ 22 F	K1.3 ■ 17 F	K2.1 ■ 25 E	K2.2 ■ 20 E	K2.3 ■ 16 E	K3.1 ■ 22 E	K3.2 ■ 17 E
K3.3 ■ 13 E	K4.1 ■ 20 E	K4.2 ■ 15 E	K4.3 ■ 11 E	K4.4 ■ 10 E	K4.5 ■ 8 E	K5.1 ■ 23 E	K5.2 ■ 17 E	K5.3 ■ 13 E	N1.1 ■ 33 J	N1.2 ■ 25 J	N1.3 ■ 17 I	N2.1 ■ 42 H	N2.2 ■ 37 H
N2.3 ■ 27 H	N3.1 ■ 56 H	N3.2 ■ 33 I	N3.3 ■ 17 G	N4.1 ■ 30 J	N4.2 ■ 28 H	N4.3 ■ 14 F	S1.1 ■ 24 F	S1.2 ■ 13 D	S1.3 ■ 7 B	S2.1 ■ 7 E	S2.2 ■ 6 A	S3.1 ■ 5 E	S3.2 ■ 4 A
S4.1 ■ 4 E	S4.2 ■ 3 A												

Product	DC	DC	SDL_1	OAL	DCON MS
	[mm]	[inch]			
A201.63X3.15 ¹⁾	0.63	0.0248	1.2 - 0.9	20.0	3.15
A201.75X3.5	0.75	0.0295	1.3 - 1.0	35.0	3.50
A2011.0X4.0	1.00	0.0394	2.1 - 1.5	35.0	4.00
A2011.5X5.0	1.50	0.0591	2.8 - 2.0	40.0	5.00
A2011.6X5.0	1.60	0.0630	2.4 - 2.0	40.0	5.00
A2012.0X6.0	2.00	0.0787	4.0 - 3.0	45.0	6.00
A2012.0X6.3	2.00	0.0787	2.9 - 2.5	45.0	6.30
A2012.5X8.0	2.50	0.0984	4.5 - 3.5	50.0	8.00
A2013.0X8.0	3.00	0.1181	4.4 - 3.9	50.0	8.00
A2013.0X10.0	3.00	0.1181	5.0 - 4.0	56.0	10.00
A2013.15X10.0	3.15	0.1240	4.4 - 3.9	56.0	10.00
A2014.0X12.0	4.00	0.1575	6.2 - 5.0	66.0	12.00
A2015.0X14.0	5.00	0.1969	7.7 - 6.5	78.0	14.00
A2016.0X18.0	6.00	0.2362	9.2 - 8.0	90.0	18.00

¹⁾ Single Ended Only.



A225



HSS Centre Drill with 120° Point angle and 60° Countersink, Bright Finish

Recommended for starting a precise hole in the end of a shaft so it can be securely held prior to machining. British Standard 328. The two drilling ends give increased productivity per tool. Suitable for drilling many materials.

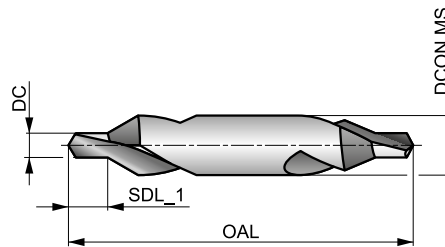

HSS	BS 328	1×D
60°	Bright	
R	120°	

Workpiece material group suitability, starting values for cutting speed (m/min) and feed Alpha Code. Tables with feed per revolution can be found starting from page 175.

P1.1 ■ 33 I	P1.2 ■ 37 I	P1.3 ■ 38 I	P2.1 ■ 28 I	P2.2 ■ 25 G	P2.3 ■ 22 E	P3.1 ■ 19 F	P3.2 ■ 15 F	P3.3 ■ 13 E	P4.1 ■ 11 F	P4.2 ■ 10 E	P4.3 ■ 8 D	M1.1 ■ 21 E	M1.2 ■ 17 E
M2.1 ■ 18 E	M2.2 ■ 15 E	M3.1 ■ 9 G	M3.2 ■ 8 G	M3.3 ■ 7 G	M4.1 ■ 10 C	K1.1 ■ 30 I	K1.2 ■ 22 F	K1.3 ■ 17 F	K2.1 ■ 25 E	K2.2 ■ 20 E	K2.3 ■ 16 E	K3.1 ■ 22 E	K3.2 ■ 17 E
K3.3 ■ 13 E	K4.1 ■ 20 E	K4.2 ■ 15 E	K4.3 ■ 11 E	K4.4 ■ 10 E	K4.5 ■ 8 E	K5.1 ■ 23 E	K5.2 ■ 17 E	K5.3 ■ 13 E	N1.1 ■ 33 J	N1.2 ■ 25 J	N1.3 ■ 17 I	N2.1 ■ 42 H	N2.2 ■ 37 H
N2.3 ■ 27 H	N3.1 ■ 56 H	N3.2 ■ 33 I	N3.3 ■ 17 G	N4.1 ■ 30 J	N4.2 ■ 28 H	N4.3 ■ 14 F	S1.1 ■ 24 F	S1.2 ■ 13 D	S1.3 ■ 7 B	S2.1 ■ 7 E	S2.2 ■ 6 A	S3.1 ■ 5 E	S3.2 ■ 4 A
S4.1 ■ 4 E	S4.2 ■ 3 A												

Products from this series are also available in set. Please see A296.

Product	Nr.	DC [inch]	DC [inch]	SDL_1 [inch]	OAL [inch]	D CONMS [inch]
A225BS1	BS1	3/64	0.0469	5/64 - 1/16	1.1/2	1/8
A225BS2	BS2	1/16	0.0625	3/32 - 5/64	1.3/4	3/16
A225BS3	BS3	3/32	0.0938	5/32 - 1/8	2"	1/4
A225BS4	BS4	1/8	0.1250	3/16 - 5/32	2.1/4	5/16
A225BS5	BS5	3/16	0.1875	9/32 - 1/4	2.1/2	7/16
A225BS5A	BSSA	7/32	0.2188	5/16 - 9/32	2.3/4	1/2
A225BS6	BS6	1/4	0.2500	3/8 - 5/16	3"	5/8
A225BS7	BS7	5/16	0.3125	15/32 - 13/32	3.1/2	3/4



A237



HSS-E (5% Cobalt) Center Drill, 118° Point, 60° Countersink, Bright Finish

Designed to start a precise hole in the end of a shaft so it can be securely held prior to machining. The two drilling ends give increased productivity per tool. It has a bright finish. Suitable for drilling many materials.

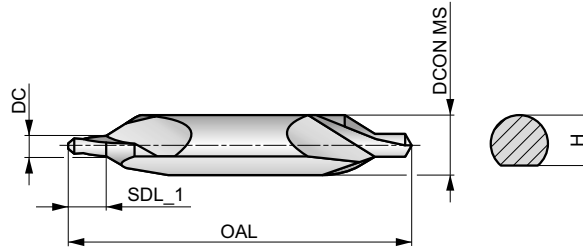

HSS-E	DIN 333A	1xD
60°	Bright	H
R	118°	

Workpiece material group suitability, starting values for cutting speed (m/min) and feed Alpha Code. Tables with feed per revolution can be found starting from page 175.

P1.1 ■ 33 I	P1.2 ■ 37 I	P1.3 ■ 38 I	P2.1 ■ 28 I	P2.2 ■ 25 G	P2.3 ■ 22 E	P3.1 ■ 19 F	P3.2 ■ 15 F	P3.3 ■ 13 E	P4.1 ■ 11 F	P4.2 ■ 10 E	P4.3 ■ 8 D	M1.1 ■ 21 E	M1.2 ■ 17 E
M2.1 ■ 18 E	M2.2 ■ 15 E	M3.1 ■ 9 G	M3.2 ■ 8 G	M3.3 ■ 7 G	M4.1 ■ 10 C	K1.1 ■ 30 I	K1.2 ■ 22 F	K1.3 ■ 17 F	K2.1 ■ 25 E	K2.2 ■ 20 E	K2.3 ■ 16 E	K3.1 ■ 22 E	K3.2 ■ 17 E
K3.3 ■ 13 E	K4.1 ■ 20 E	K4.2 ■ 15 E	K4.3 ■ 11 E	K4.4 ■ 10 E	K4.5 ■ 8 E	K5.1 ■ 23 E	K5.2 ■ 17 E	K5.3 ■ 13 E	N1.1 ■ 33 J	N1.2 ■ 25 J	N1.3 ■ 17 I	N2.1 ■ 42 H	N2.2 ■ 37 H
N2.3 ■ 27 H	N3.1 ■ 56 H	N3.2 ■ 33 I	N3.3 ■ 17 G	N4.1 ■ 30 J	N4.2 ■ 28 H	N4.3 ■ 14 F	S1.1 ■ 24 F	S1.2 ■ 13 D	S1.3 ■ 7 B	S2.1 ■ 7 E	S2.2 ■ 6 A	S3.1 ■ 5 E	S3.2 ■ 4 A
S4.1 ■ 4 E	S4.2 ■ 3 A												

Product	DC	DC	SDL_1	OAL	DCON MS	H
	[mm]	[inch]	[mm]	[mm]	[mm]	[mm]
A2371.6X4.0	1.60	0.0630	2.6 - 2.0	35.0	4.00	3.25 - 3.15
A2372.0X5.0	2.00	0.0787	3.1 - 2.5	40.0	5.00	4.20 - 4.10
A2372.5X6.3	2.50	0.0984	3.8 - 3.1	45.0	6.30	5.35 - 5.25
A2373.15X8.0	3.15	0.1240	4.6 - 3.9	50.0	8.00	6.95 - 6.85
A2374.0X10.0	4.00	0.1575	5.9 - 5.0	55.0	10.00	8.40 - 8.30
A2375.0X12.5	5.00	0.1969	7.2 - 6.3	63.0	12.50	10.95 - 10.85
A2376.3X16.0	6.30	0.2480	8.9 - 8.0	71.0	16.00	14.00 - 13.90
A2378.0X20.0	8.00	0.3150	11.1 - 10.1	80.0	20.00	17.90 - 17.80
A23710.0X25.0	10.00	0.3937	13.8 - 12.8	100.0	25.00	22.50 - 22.40



A238



HSS-E (5% Co) Center Drill, 118° Point, Concave Countersink, Bright Finish

Designed to start a precise hole in the end of a shaft so it can be securely held prior to machining. The two drilling ends give increased productivity per tool. Suitable for drilling many materials. Bright finish and can be used with special chamfering adaptors.

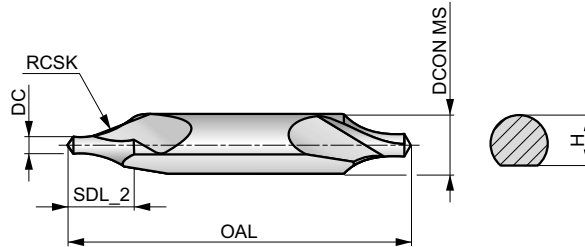

HSS-E	DIN 333R	1×D
R	Bright	H
R	118°	

Workpiece material group suitability, starting values for cutting speed (m/min) and feed Alpha Code. Tables with feed per revolution can be found starting from page 175.

P1.1 ■ 33 I	P1.2 ■ 37 I	P1.3 ■ 38 I	P2.1 ■ 28 I	P2.2 ■ 25 G	P2.3 ■ 22 E	P3.1 ■ 19 F	P3.2 ■ 15 F	P3.3 ■ 13 E	P4.1 ■ 11 F	P4.2 ■ 10 E	P4.3 ■ 8 D	M1.1 ■ 21 E	M1.2 ■ 17 E
M2.1 ■ 18 E	M2.2 ■ 15 E	M3.1 ■ 9 G	M3.2 ■ 8 G	M3.3 ■ 7 G	M4.1 ■ 10 C	K1.1 ■ 30 I	K1.2 ■ 22 F	K1.3 ■ 17 F	K2.1 ■ 25 E	K2.2 ■ 20 E	K2.3 ■ 16 E	K3.1 ■ 22 E	K3.2 ■ 17 E
K3.3 ■ 13 E	K4.1 ■ 20 E	K4.2 ■ 15 E	K4.3 ■ 11 E	K4.4 ■ 10 E	K4.5 ■ 8 E	K5.1 ■ 23 E	K5.2 ■ 17 E	K5.3 ■ 13 E	N1.1 ■ 33 J	N1.2 ■ 25 J	N1.3 ■ 17 I	N2.1 ■ 42 H	N2.2 ■ 37 H
N2.3 ■ 27 H	N3.1 ■ 56 H	N3.2 ■ 33 I	N3.3 ■ 17 G	N4.1 ■ 30 J	N4.2 ■ 28 H	N4.3 ■ 14 F	S1.1 ■ 24 F	S1.2 ■ 13 D	S1.3 ■ 7 B	S2.1 ■ 7 E	S2.2 ■ 6 A	S3.1 ■ 5 E	S3.2 ■ 4 A
S4.1 ■ 4 E	S4.2 ■ 3 A												

Product	DC	DC	SDL_2	OAL	RCSK	DCON MS	H
	[mm]	[inch]	[mm]	[mm]	[mm]	[mm]	[mm]
A2381.6X4.0	1.60	0.0630	4.7 - 4.2	35.0	5.00 - 4.00	4.00	3.25 - 3.15
A2382.0X5.0	2.00	0.0787	5.4 - 5.0	40.0	6.25 - 5.00	5.00	4.20 - 4.10
A2382.5X6.3	2.50	0.0984	6.8 - 6.3	45.0	7.88 - 6.30	6.30	5.35 - 5.25
A2383.15X8.0	3.15	0.1240	8.5 - 8.0	50.0	10.00 - 8.00	8.00	6.95 - 6.85
A2384.0X10.0	4.00	0.1575	10.6 - 10.0	55.0	12.50 - 10.00	10.00	8.40 - 8.30
A2385.0X12.5	5.00	0.1969	13.1 - 12.5	63.0	15.63 - 12.50	12.50	10.95 - 10.85
A2386.3X16.0	6.30	0.2480	16.6 - 16.0	71.0	20.00 - 16.00	16.00	14.00 - 13.90
A2388.0X20.0	8.00	0.3150	20.7 - 20.0	80.0	25.00 - 20.00	20.00	17.90 - 17.80



A242

DORMER



HSS-E (5% Co) Long Center Drill, 118° Point, 60° Countersink, Bright Finish

Designed to start a precise hole in the end of a shaft so it can be securely held prior to machining. The two drilling ends give increased productivity per tool. Suitable for drilling many materials.

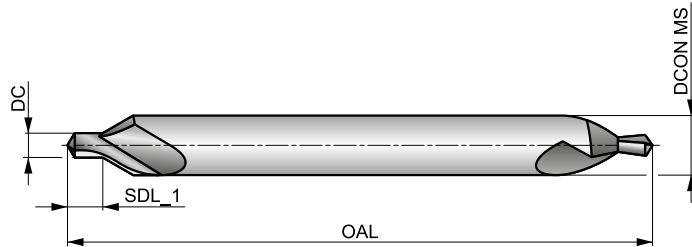

HSS-E		1×D
60°	Bright	
R	118°	

Workpiece material group suitability, starting values for cutting speed (m/min) and feed Alpha Code. Tables with feed per revolution can be found starting from page 175.

P1.1 ■ 33 I	P1.2 ■ 37 I	P1.3 ■ 38 I	P2.1 ■ 28 I	P2.2 ■ 25 G	P2.3 ■ 22 E	P3.1 ■ 19 F	P3.2 ■ 15 F	P3.3 ■ 13 E	P4.1 ■ 11 F	P4.2 ■ 10 E	P4.3 ■ 8 D	M1.1 ■ 21 E	M1.2 ■ 17 E
M2.1 ■ 18 E	M2.2 ■ 15 E	M3.1 ■ 9 G	M3.2 ■ 8 G	M3.3 ■ 7 G	M4.1 ■ 10 C	K1.1 ■ 30 I	K1.2 ■ 22 F	K1.3 ■ 17 F	K2.1 ■ 25 E	K2.2 ■ 20 E	K2.3 ■ 16 E	K3.1 ■ 22 E	K3.2 ■ 17 E
K3.3 ■ 13 E	K4.1 ■ 20 E	K4.2 ■ 15 E	K4.3 ■ 11 E	K4.4 ■ 10 E	K4.5 ■ 8 E	K5.1 ■ 23 E	K5.2 ■ 17 E	K5.3 ■ 13 E	N1.1 ■ 33 J	N1.2 ■ 25 J	N1.3 ■ 17 I	N2.1 ■ 42 H	N2.2 ■ 37 H
N2.3 ■ 27 H	N3.1 ■ 56 H	N3.2 ■ 33 I	N3.3 ■ 17 G	N4.1 ■ 30 J	N4.2 ■ 28 H	N4.3 ■ 14 F	S1.1 ■ 24 F	S1.2 ■ 13 D	S1.3 ■ 7 B	S2.1 ■ 7 E	S2.2 ■ 6 A	S3.1 ■ 5 E	S3.2 ■ 4 A
S4.1 ■ 4 E	S4.2 ■ 3 A												

Product	DC	DC	SDL_1	OAL	DCON MS
	[mm]	[inch]	[mm]	[mm]	[mm]
A2421.0X4.0	1.00	0.0394	1.7 - 1.3	100.0	4.00
A2421.5X5.0	1.50	0.0591	2.6 - 2.0	100.0	5.00
A2422.0X6.0	2.00	0.0787	3.1 - 2.5	100.0	6.00
A2422.5X8.0	2.50	0.0984	3.8 - 3.1	100.0	8.00
A2423.0X8.0	3.00	0.1181	4.6 - 3.9	100.0	8.00
A2423.0X10.0	3.00	0.1181	4.6 - 3.9	100.0	10.00
A2424.0X10.0	4.00	0.1575	5.9 - 5.0	100.0	10.00
A2424.0X12.0	4.00	0.1575	5.9 - 5.0	100.0	12.00
A2425.0X12.0	5.00	0.1969	7.2 - 6.3	100.0	12.00



A088



HSS Stub Drill Set with A022 Drills, TiN-Tip Coated

A set containing 24 different diameters of the A022 stub drill in a sturdy case, for a wide range of hole sizes covered with a single purchase. The drills are suitable for use both in machines and hand-held drilling in many applications. TiN-Tip coating improves performance and extends tool life.

HSS	DIN ANSI	2.5×D
135°	TiN-Tip	
20-35°	R	DC h8

A=Styles in Set, B=No. in Set, C=Diameters in Set.

Product	Nr.	A	B	C
A0882005	2005	A022	24	1.0 mm - 10.5 mm x 0.5 mm + 3.3 mm, 4.2 mm, 6.8 mm, 10.2 mm

A095



HSS Jobber Drill Set with A002 Drills, TiN-Tip Coated

Different sets in metric or fractional sizes of our A002 drills in a useful plastic storage case. The set keeps all drills together, with sizes clearly displayed for easy selection. The drills are suitable for use in both machines and hand-held applications. TiN-Tip coating improves performance and extends tool life.

HSS	DIN 338	4×D
118°	TiN-Tip	
20-35°	R	DC h8

1.0mm =< DC >= 2.9mm 118° 4 Facet Point. A=Styles in Set, B=No. in Set, C=Diameters in Set.

Product	Nr.	A	B	C
A09518	18	A002	29	1/16 inch - 1/2 inch x 1/64 inch
A09520	20	A002	15	1/16 inch - 1/2 inch x 1/32 inch
A095200	200	A002	24	1.0 mm - 10.5 mm x 0.5 mm + 3.3 mm, 4.2 mm, 6.8 mm, 10.2 mm
A095201	201	A002	19	1.0 mm - 10.0 mm x 0.5 mm
A095202	202	A002	51	1.0 mm - 6.0 mm x 0.1 mm
A095203	203	A002	41	6.0 mm - 10.0 mm x 0.1 mm
A095204	204	A002	25	1.0 mm - 13.0 mm x 0.5 mm
A095206	206	A002	29	1.0 mm - 13.0 mm x 0.5 mm + 3.3 mm, 4.2 mm, 6.8 mm, 10.2 mm
A095209	209	A002	91	1.0 mm - 10.0 mm x 0.1 mm



A087

DORMER



HSS Jobber Drill Set with A002 Drills, TiN-Tip Coated

A set containing 19 different diameters of the popular A002 drill in an easy to carry compact case, with sizes clearly displayed for easy selection. The drills are suitable for use both in machines and hand-held drilling, and in many applications. TiN-Tip coating improves performance and extends tool life.

HSS	DIN 338	4×D
118°	TiN-Tip	
λ 20-35°	R	DC h8

A=Styles in Set, B=No. in Set, C=Diameters in Set. 1.0mm =< DC >= 2.9mm 118° 4 Facet Point.

Product	Nr.	A	B	C
A087201	201	A002	19	1.0 mm - 10.0 mm x 0.5 mm

A094

DORMER



HSS Jobber Drill Set with A002 Drills, TiN-Tip Coated

A set containing A002 drills of different metric diameters in a cleverly designed rotating dispenser which makes selecting the required size very simple. Rotate the clear plastic top, until the required size is highlighted by the hole in the case, and turn the set upside down to remove the drill.

HSS	DIN 338	4×D
118°	TiN-Tip	
λ 20-35°	R	DC h8

A=Styles in Set, B=No. in Set, C=Diameters in Set. 1.0mm =< DC >= 2.9mm 118° 4 Facet Point.

Product	Nr.	A	B	C
A094413	413	A002	13	1.5 mm - 6.5 mm x 0.5 mm + 3.3 mm, 4.2 mm
A094419	419	A002	19	1.0 mm - 10.0 mm x 0.5 mm



A089



HSS Jobber Drill Set with A002 Drills, TiN-Tip Coated

A set containing 5 different diameters of the popular A002 drill in a handy container, covering many diameters with a single purchase. The drills are suitable for use both in machines and hand-held drilling in many applications. TiN-Tip coating improves performance and extends tool life.

HSS	DIN 338	4xD
118°	TiN-Tip	
20-35°	R	DC h8

A=Styles in Set, B=No. in Set, C=Diameters in Set.

Product	Nr.	A	B	C
A08910	10	A002	5	A0024.0, A0025.0, A0026.0, A0028.0, A00210.0



A099



Counter Dispenser Display with HSS Jobber A002 Drills, TiN-Tip Coated

A free standing counter top dispenser containing a wide range of sizes of A002 drills. Designed to stand on a counter top or other suitable flat surface for a prominent display and where the drills can be easily removed as and when needed. Easy to refill with further A002 drills, it will give years of service.

HSS	DIN 338	4xD
118°	TiN-Tip	
λ 20-35°	R	DC h8

1.0mm =< DC >= 2.9mm 118° 4 Facet Point. A=Styles in Set, B=No. in Set, C=Diameters in Set.

Product	Nr.	A	B	C
A099F1	F1	A002	380	5 x (13/32, 7/16, 15/32, 1/2) inch; 10 x (5/64, 7/64, 9/64, 11/64, 13/64, 15/64, 17/64, 9/32, 19/64, 5/16, 21/64, 11/32, 23/64, 3/8) inch; 20 x (1/16, 7/32, 1/4) inch; 30 x 3/32 inch; 40 x (5/32, 3/16) inch; 50 x 1/8 inch
A099M1	M1	A002	340	5 x (10.50, 11.00, 11.50, 12.00, 12.50, 13.00) mm; 10 x (1.50, 2.50, 3.50, 4.50, 5.50, 6.50, 7.00, 7.50, 8.00, 8.50, 9.00, 9.50, 10.00) mm; 20 x (1.00, 5.00, 6.00) mm; 30 x 2.00 mm; 40 x 4.00 mm; 50 x 3.00 mm

A099



Drillboy with HSS Jobber A002 Drills, TiN-Tip Coated

A free standing counter top dispenser containing a wide range of sizes of A002 drills. Designed to stand on a counter top or other suitable flat surface for a prominent display and where the drills can be easily removed as and when needed. Easy to refill with further A002 drills, it will give years of service.

HSS	DIN 338	4xD
118°	TiN-Tip	
λ 20-35°	R	DC h8

1.0mm =< DC >= 2.9mm 118° 4 Facet Point. A=Styles in Set, B=No. in Set, C=Diameters in Set.

Product	Nr.	A	B	C
A099DRILLBOY	DRILLBOY	A002	43	3 x (3.0 mm, 3.3 mm, 3.5 mm, 4.0 mm) + 2 x (4.2 mm, 4.5 mm, 5.0 mm, 5.5 mm, 6.0 mm, 6.5 mm, 6.8 mm, 7.0 mm, 7.5 mm, 8.0 mm) + 8.5 mm, 9.0 mm, 9.5 mm, 10.0 mm, 10.2 mm, 10.5 mm, 11.0 mm, 11.5 mm, 12.0 mm, 12.5 mm, 13.0 mm



A199



Counter Dispenser Display with HSS A100 Jobber Drills

A free standing counter top dispenser containing a wide range of sizes of A100 drills. Designed to stand on a counter top or other suitable flat surface for a prominent display and where the drills can be easily removed when needed. Easy to refill with further A100 drills, it will give years of service.

HSS	DIN 338	4xD
118°	ST	
2.20-35°	R	DC h8

A=Styles in Set, B=No. in Set, C=Diameters in Set.

Product	Nr.	A	B	C
A199F1	F1	A100	380	5 x (13/32, 7/16, 15/32, 1/2) inch; 10 x (5/64, 7/64, 9/64, 11/64, 13/64, 15/64, 17/64, 9/32, 19/64, 5/16, 21/64, 11/32, 23/64, 3/8) inch; 20 x (1/16, 7/32, 1/4) inch; 30 x 3/32 inch; 40 x (5/32, 3/16) inch; 50 x 1/8 inch
A199M1	M1	A100	340	5 x (10.50, 11.00, 11.50, 12.00, 12.50, 13.00) mm; 10 x (1.50, 2.50, 3.50, 4.50, 5.50, 6.50, 7.00, 7.50, 8.00, 8.50, 9.00, 9.50, 10.00) mm; 20 x (1.00, 5.00, 6.00) mm; 30 x 2.00 mm; 40 x 4.00 mm; 50 x 3.00mm

A080



Empty Dispenser

The dispenser is supplied empty so the drills can be purchased separately, choosing quantities to suit counter sales. It comes in red plastic, marked with a Dormer logo and an image of various Dormer drills. Metric or Fractional drill diameters are marked on the three shelves.

Empty Dispenser.

Product	Nr.	C
A080M1EMPTY	M1EMPTY	(1.00, 1.50, 2.00, 2.50, 3.00, 3.50, 4.00, 4.50, 5.00, 5.50, 6.00, 6.50, 7.00, 7.50, 8.00, 8.50, 9.00, 9.50, 10.00, 10.50, 11.00, 11.50, 12.00) mm
A080F1EMPTY	F1EMPTY	(1/16, 5/64, 3/32, 7/64, 1/8, 9/64, 5/32, 11/64, 3/16, 13/64, 7/32, 15/64, 1/4, 17/64, 9/32, 19/64, 5/16, 21/64, 11/32, 3/8, 13/32, 7/16, 1/2) inch



A190



HSS Jobber Drill Set with A100 Drills, Steam Tempered Finish

Drill set containing A100 jobber drills with conventional 118° point. Provided in metric or fractional size sets in a handy plastic case which makes selecting the required drill size very simple.

HSS	DIN 338	4×D
118°	ST	
λ 20-35°	R	DC h8

A=Styles in Set, B=No. in Set, C=Diameters in Set. DC ≤ 1mm; 3/64"; N60 Bright.

Product	Nr.	A	B	C
A1903	3	A100	21	1/16 inch - 3/8 inch x 1/64 inch
A19012	12	A100	60	No.1 - No.60
A19018	18	A100	29	1/16 inch - 1/2 inch x 1/64 inch
A19020	20	A100	15	1/16 inch - 1/2 inch x 1/32 inch
A190201	201	A100	19	1.0 mm - 10.0 mm x 0.5 mm
A190202	202	A100	51	1.0 mm - 6.0 mm x 0.1 mm
A190203	203	A100	41	6.0 mm - 10.0 mm x 0.1 mm
A190204	204	A100	25	1.0 mm - 13.0 mm x 0.5 mm
A190206	206	A100	29	1.0 mm - 13.0 mm x 0.5 mm + 3.3 mm, 4.2 mm, 6.8 mm, 10.2 mm
A190209 ¹⁾	209	A100	91	1.0 mm - 10.0 mm x 0.1 mm

¹⁾ Sold in 2 boxes: box 1 contains sizes (1.0-5.9 x 0.1mm); box 2 contains sizes (6.0-10.0 x 0.1mm).



A191

DORMER

HSS Jobber Drill Set with A100 Drills, Steam Tempered Finish

A set containing A100 drills of different metric diameters in an easy to carry compact case with sizes clearly displayed and easy drill selection. A100 jobber drills with Conventional 118° point. Provided in metric or wire size sets in a handy plastic case which makes selecting the required drill size very simple.



HSS	DIN 338	4xD
118°	ST	
20-35°	R	DC h8

A=Styles in Set, B=No. in Set, C=Diameters in Set. DC ≤ 1mm; 3/64"; N60 Bright.

Product	Nr.	A	B	C
A19131M	31M	A100	20	0.3 mm - 1.0 mm x 0.05 mm + 0.38 mm, 0.52 mm, 0.58 mm, 0.78 mm, 0.82 mm
A19161-80	61-80	A100	20	No.61 - No. 80

A191

DORMER

HSS Jobber Drill Set with A100 Drills, Steam Tempered Finish

A set containing A100 drills of different metric diameters in a cleverly designed rotating dispenser which makes selecting the required size very simple. Rotate the clear plastic top, until the required size is highlighted by the hole in the case, and turn the set upside down to remove the drill.



HSS	DIN 338	4xD
118°	ST	
20-35°	R	DC h8

A=Styles in Set, B=No. in Set, C=Diameters in Set. DC ≤ 1mm; 3/64"; N60 Bright.

Product	Nr.	A	B	C
A191413	413	A100	13	1.5 mm - 6.5 mm x 0.5 mm + 3.3 mm, 4.2 mm
A191419	419	A100	19	1.0 mm - 10.0 mm x 0.5 mm



A188

DORMER



HSS Jobber Drill Set with A108 Drills, Steam Tempered Finish

A set of different fractional sizes of our A108 drills in a useful plastic storage case. Can be used in many different machine and hand-held applications.

HSS	DIN 338	4xD
135°		
$\lambda > 35^\circ$		DC h8

A=Styles in Set, B=No. in Set, C=Diameters in Set. DC > 1.5mm; 1/16" Split Point

Product	Nr.	A	B	C
A188201	201	A108	19	1.0 mm - 10.0 mm x 0.5 mm
A188204	204	A108	25	1.0 mm - 13.0 mm x 0.5 mm

A295

DORMER



HSS-E (8% Cobalt) Jobber Drill Set with A777 Drills, Bronze Surface Finish

A set of different fractional sizes of our A777 drills in a useful plastic storage case. The set keeps all of the drills together in order, with sizes clearly displayed for easy selection. The A777 drills are designed with a 135° split point to help self-center the drill and reduce the cutting forces.

HSS-E	DIN 338	4xD
135°		
$\lambda 20-35^\circ$		DC h8

A=Styles in Set, B=No. in Set, C=Diameters in Set. DC <= 1.4mm 4 Facet Point.

Product	Nr.	A	B	C
A295219	219	A777	19	1.0 mm - 10.0 mm x 0.5 mm
A295225	225	A777	25	1.0 mm - 13.0 mm x 0.5 mm



A296

DORMER



HSS Centre Drill Set

A set of five center drills which come in a handy plastic case to keep all your drills together. Recommended for starting a precise hole in the end of a shaft it can be securely held prior to machining. The two drilling ends gives increased productivity per tool.

A296200 - 118° point DIN333A, A296225 - 120° point BS328. A=Styles in Set, B=No. in Set, C=Diameters in Set.

Product	Nr.	A	B	C
A296200	200	A200	5	1.00 mm, 2.00 mm, 2.50 mm, 3.15 mm, 4.00 mm
A296225	225	A225	5	BS1, BS2, BS3, BS4, BS5

M150

DORMER



Morse Tapered Sleeve, Oil Toughened

Adaptor used to enable drills with smaller taper shanks to be held in machine spindles with larger morse tapers.

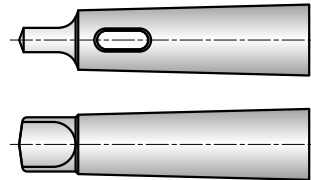

K= External Morse Cone; K1=Internal Morse Cone.

Product	Nr.	K = Nr.	K1 = Nr.
M1501-0	10	Nr. 1	Nr. 0
M1502-1	21	Nr. 2	Nr. 1
M1503-1	31	Nr. 3	Nr. 1
M1504-1	41	Nr. 4	Nr. 1
M1503-2	32	Nr. 3	Nr. 2
M1504-2	42	Nr. 4	Nr. 2
M1505-2	52	Nr. 5	Nr. 2
M1504-3	43	Nr. 4	Nr. 3
M1505-3	53	Nr. 5	Nr. 3
M1505-4	54	Nr. 5	Nr. 4
M1506-5	65	Nr. 6	Nr. 5



M151

DORMER



Morse Tapered Sleeve, Hardened and Ground

Adaptor used to enable drills with smaller taper shanks to be held in machine spindles with larger morse tapers.

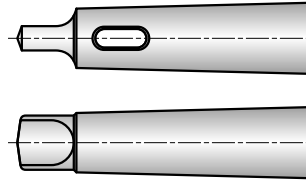

K= External Morse Cone; K1=Internal Morse Cone.

Product	Nr.	K = Nr.	K1 = Nr.
M1511-0	10	Nr. 1	Nr. 0
M1512-1	21	Nr. 2	Nr. 1
M1513-1	31	Nr. 3	Nr. 1
M1514-1	41	Nr. 4	Nr. 1
M1513-2	32	Nr. 3	Nr. 2
M1514-2	42	Nr. 4	Nr. 2
M1515-2	52	Nr. 5	Nr. 2
M1514-3	43	Nr. 4	Nr. 3
M1515-3	53	Nr. 5	Nr. 3
M1515-4	54	Nr. 5	Nr. 4
M1516-5	65	Nr. 6	Nr. 5

M152

DORMER



Drill Drift

Used to eject taper shank drills from machine spindles and morse taper sleeves.



Product	Nr.
M1520	Nr. 0
M15212	Nr. 1 + 2
M15234	Nr. 3 + 4
M15245	Nr. 4 + 5
M1526	Nr. 6



DRILLING FEED RATE CHART

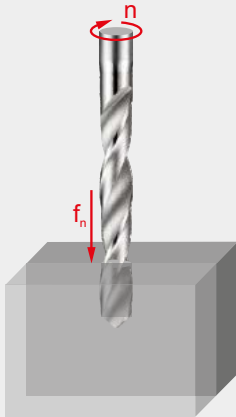

Feed per revolution (f_n in mm/rev)
Depending on the working conditions
it might be necessary to adjust these
values $\pm 25\%$.

How to use this table to find the feed per revolution (f_n):

1. Find your Alpha Code on the product page (example: 46J, "J" is the Alpha Code).
2. Find the closest diameter for your cutting application in the top row of the table.
3. Find your Alpha Code in the left column of the table.
4. The intersection (cell) of the Diameter and Alpha Code is the feed per revolution (f_n).

		\varnothing DC [mm]																		
		0.15	0.50	1.00	2.00	3.00	4.00	5.00	6.00	8.00	10.00	12.00	15.00	16.00	20.00	25.00	30.00	40.00	50.00	100.00
Feed rates	A	0.003	0.006	0.012	0.023	0.029	0.032	0.036	0.042	0.054	0.062	0.069	0.082	0.086	0.110	0.125	0.135	0.155	0.175	0.263
	B	0.004	0.007	0.014	0.028	0.037	0.041	0.046	0.053	0.067	0.080	0.090	0.103	0.108	0.135	0.153	0.165	0.188	0.208	0.312
	C	0.004	0.008	0.015	0.032	0.044	0.050	0.056	0.064	0.080	0.098	0.110	0.125	0.130	0.160	0.180	0.195	0.220	0.240	0.360
	D	0.004	0.008	0.016	0.038	0.053	0.060	0.068	0.078	0.098	0.119	0.130	0.149	0.155	0.188	0.210	0.228	0.253	0.275	0.413
	E	0.004	0.009	0.017	0.043	0.062	0.071	0.080	0.092	0.115	0.140	0.150	0.173	0.180	0.215	0.240	0.260	0.285	0.310	0.465
	F	0.005	0.009	0.018	0.050	0.073	0.084	0.095	0.109	0.138	0.165	0.178	0.202	0.210	0.248	0.275	0.295	0.320	0.343	0.515
	G	0.005	0.010	0.019	0.056	0.084	0.096	0.109	0.126	0.160	0.190	0.205	0.231	0.240	0.280	0.310	0.330	0.355	0.375	0.563
	H	0.005	0.010	0.020	0.066	0.102	0.116	0.130	0.150	0.190	0.228	0.243	0.271	0.280	0.320	0.355	0.375	0.398	0.418	0.627
	I	0.005	0.011	0.021	0.076	0.119	0.134	0.150	0.173	0.220	0.265	0.280	0.310	0.320	0.360	0.400	0.420	0.440	0.460	0.690
	J	0.006	0.012	0.024	0.084	0.135	0.152	0.170	0.197	0.250	0.298	0.315	0.349	0.360	0.405	0.445	0.465	0.485	0.503	0.755
	K	0.007	0.013	0.026	0.092	0.150	0.170	0.190	0.220	0.280	0.330	0.350	0.388	0.400	0.450	0.490	0.510	0.530	0.545	0.818
	L	0.007	0.014	0.028	0.101	0.165	0.186	0.208	0.240	0.305	0.360	0.385	0.419	0.430	0.485	0.525	0.545	0.568	0.588	0.882
	M	0.008	0.015	0.030	0.110	0.180	0.202	0.225	0.260	0.330	0.390	0.420	0.450	0.460	0.520	0.560	0.580	0.605	0.630	0.945
	N	0.008	0.016	0.032	0.119	0.195	0.218	0.242	0.280	0.355	0.420	0.455	0.481	0.490	0.555	0.595	0.615	0.642	0.672	1.008
	S	0.002	0.004	0.008	0.014	0.020	0.025	0.030	0.037	0.050	0.080	0.100	0.123	0.130	0.150	0.170	0.190	0.220	0.240	–
	T	0.004	0.008	0.015	0.028	0.040	0.050	0.060	0.070	0.090	0.110	0.130	0.160	0.170	0.190	0.210	0.230	0.260	0.275	–
	U	0.007	0.013	0.026	0.048	0.070	0.080	0.090	0.107	0.140	0.170	0.200	0.223	0.230	0.240	0.270	0.300	0.360	0.375	–
	V	0.010	0.019	0.038	0.069	0.100	0.115	0.130	0.153	0.200	0.250	0.280	0.310	0.320	0.340	0.400	0.440	0.510	0.530	–
	W	0.012	0.025	0.049	0.089	0.130	0.150	0.170	0.200	0.260	0.330	0.380	0.418	0.430	0.450	0.470	0.490	0.520	0.540	–
	X	0.014	0.028	0.056	0.103	0.150	0.180	0.210	0.250	0.330	0.420	0.480	0.533	0.550	0.580	–	–	–	–	–
Y	0.017	0.034	0.068	0.124	0.180	0.220	0.260	0.317	0.430	0.550	0.700	0.700	0.700	0.740	–	–	–	–	–	
Z	0.024	0.047	0.094	0.172	0.250	0.325	0.400	0.533	0.800	1.000	1.100	1.175	1.200	1.200	–	–	–	–	–	



DRILLS

TECHNICAL INFORMATION





SOLID CARBIDE & HSS DRILLS – TECHNICAL INFO

Drill Nomenclature

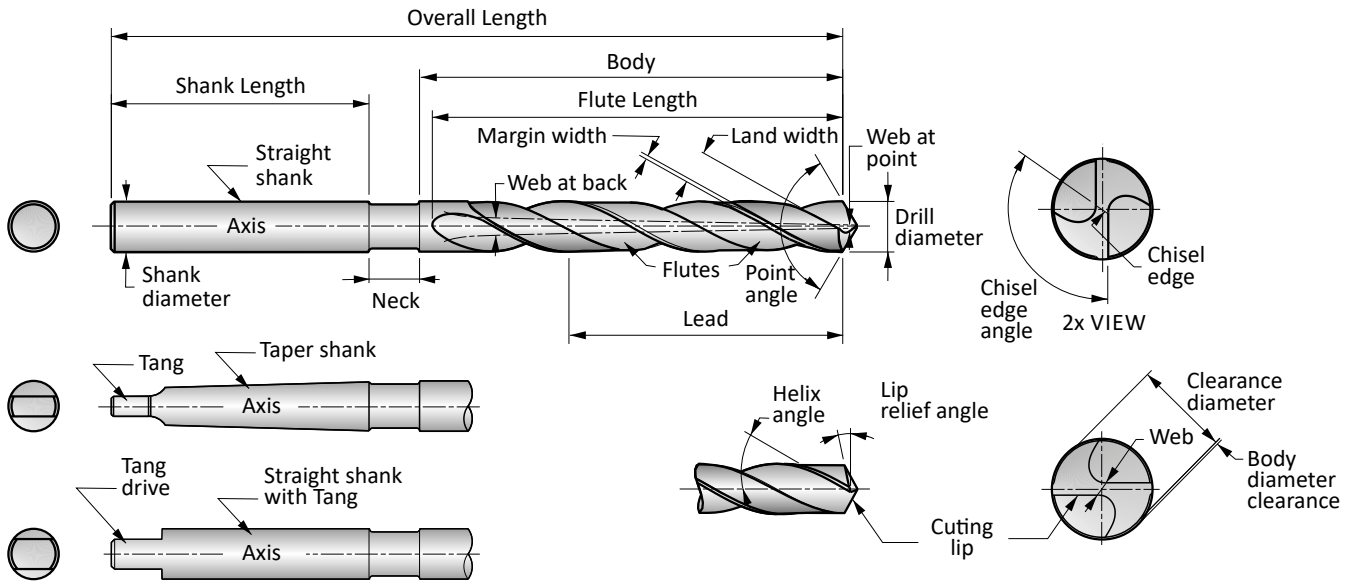

- **Axis** — The imaginary straight line which forms the longitudinal centre line of a drill.
- **Backtaper** — A slight decrease in diameter from front to back in the body of a drill.
- **Body** — The portion of a drill extending from the shank or neck to the outer corners of the cutting lips.
- **Body Clearance Diameter** — The portion of the land that has been cut away so it will not bind against the walls of the hole.
- **Chisel-Edge** — The edge at the end of the web that connects the cutting lips.
- **Chisel-Edge Angle** — The included angle between the chisel-edge and cutting lip, as viewed from the end of a drill.
- **Clearance Diameter** — The diameter over the cut away portion of the drill lands.
- **Drill** — A rotary end cutting tool having one or more cutting lips, and having one or more helical or straight flutes for the passage of chips and the admission of a cutting fluid.
- **Drill Diameter** — The diameter over the margins of a drill measured at the point.
- **Flute Length** — The length from the outer corners of the cutting lips to the extreme back of the flutes. Includes the sweep of the tool used to generate the flutes and therefore does not indicate the usable length of flutes.
- **Flutes** — Helical or straight grooves cut or formed in the body of a drill to provide cutting lips, permit removal of chips, and allow cutting fluid to reach the cutting lips.
- **Helix Angle** — The angle formed by the leading edge of the land with a plane containing the axis of a drill.
- **Land** — The peripheral portion of the body between adjacent flutes.
- **Land Width** — The distance between the leading edge and heel of the land; measured at a right angle to the leading edge.
- **Lead** — The axial advance of a leading edge of the land in one turn around the circumference.
- **Lip Relief Angle** — The axial relief angle at the outer corner of the lip; measured by projection to a plane tangent to the periphery at the outer corner of the lip.
- **Lips** — The cutting edges of a two flute drill extending from the chisel-edge to the periphery.
- **Margin** — The cylindrical portion of the land, which is not cut away, to provide clearance.
- **Neck** — The section of reduced diameter between the body and the shank of a drill.
- **Overall Length** — The length from the extreme end of the shank to the outer corners of the cutting lip. It does not include the conical shank end often used on straight shank drills, nor the conical cutting point used on both straight and taper shank drills.
- **Point** — The cutting end of a drill, made up of the ends of the lands and the web. In form, it resembles a cone, but departs from a true cone to furnish clearance behind the cutting lips.
- **Conventional** — Conventional Points with 118° included point angles are the most commonly used because they provide satisfactory results in a wide variety of materials. A possible limitation is that the straight chisel edge contributes to wandering at the drill point, often making it necessary to spot the hole for improved accuracy.

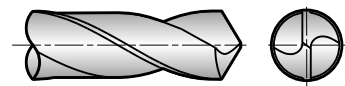

- **Split** — Split-Points (commonly called Crankshaft Points) were originally developed for use on drills designed for deep oil holes in automotive crankshafts. Since its inception, the split-point has gained widespread use and is applied to both 118° and 135° included point angles. Its main advantages are the ability to reduce thrust and eliminate wandering at the drill point. This is a distinct advantage when the drill is used in a portable drill or in drilling applications where bushings cannot be used. The split-point also has two positive rake cutting edges extending to the centre of the drill, which can assist as a chipbreaker to produce small chips which can readily be ejected.

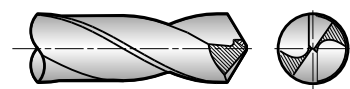

SOLID CARBIDE & HSS DRILLS – TECHNICAL INFO

- **Notched** — Notched Points were developed for drilling tough alloys. Commonly incorporated on heavy web drills, which allow the point to withstand the higher thrust loads required in drilling these materials. As with the split-point, the Notched Point contains two additional positive rake cutting edges extending toward the centre of the drill. These secondary cutting lips, which extend no further than half the original cutting lip, can assist in chip control and reduce the torque required in drilling tough materials. Notched Points can be incorporated on both 118° and 135° included point angles, making them suitable for drilling a wide variety of materials.

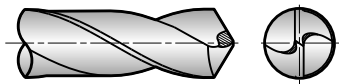

- **Point Angle** — The included angle between the cutting lips projected upon a plane parallel to the drill axis and parallel to the two cutting lips.
- **Relative Lip Height** — The difference in indicator reading between the cutting lips of a drill. Measured at a right angle to the cutting lip at a specific distance from the axis of the tool.
- **Shank** — The part of a drill by which it is held and driven.
- **Tang** — The flattened end of a taper shank, intended to fit into a driving slot in a socket.
- **Tang Drive** — Two opposite parallel driving flats on the extreme end of a straight shank.
- **Taper Shank** — Drills having conical shanks suitable for direct fitting in machine spindles, driving sleeves, or sockets. Tapered shanks generally have a tang.
- **Web** — The central portion of the body that joins the lands. The extreme end of the web forms the chisel-edge on a two flute drill.
- **Web Thickness** — The thickness of the web at the point, unless another specific location is indicated.

General hints on drilling

1. Select the most appropriate drill for the application, bearing in mind the material to be machined, the capability of the machine tool and the coolant to be used.
2. Flexibility within the component and machine tool spindle can cause damage to the drill as well as the component and machine - ensure maximum stability at all times. This can be improved by selecting the shortest possible drill for the application.
3. Tool holding is an important aspect of the drilling operation and the drill cannot be allowed to slip or move in the tool holder.
4. The correct use of Morse Taper Shank drills relies on an efficient fit between the taper surfaces of the tool and the tool holder. The use

of a soft-faced hammer should be used to drive the drill into the holder.

5. The use of suitable coolants and lubricants are recommended as required by the particular drilling operation. When using coolants and lubricants, ensure a copious supply, especially at the drill point.
6. Swarf evacuation whilst drilling is essential in ensuring the correct drilling procedure. Never allow the swarf to become stationary in the flute.
7. When regrinding a drill, always make sure that the correct point geometry is produced and that any wear has been removed.



SOLID CARBIDE & HSS DRILLS – TECHNICAL INFO

Deep hole drilling strategy

When drilling deep holes, several methods can be adopted to achieve the depth required. The example below shows four ways of drilling a hole with 10× the diameter of the drill.

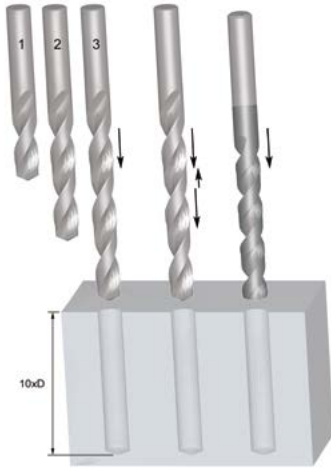

	Series Drilling	Series Drilling
No of drills	3 (2.5×D, 6×D, 10×D)	2 (2.5×D, 10×D)
Type of drill	Standard geometry, general purpose	Standard geometry, general purpose
+ / -	Expensive Time consuming	More cost effective Quick

	Peck Drilling	Single Pass Drilling
No of drills	1 (10×D)	1 (10×D)
Type of drill	Standard geometry, general purpose	Purpose specific tools
+ / -	Time consuming	Cost effective Fast

Trouble shooting when drilling

Problem	Cause	Remedy
Broken or twisted tangs	Bad fit between shank and socket	Ensure the shank and socket are clean and free from damage
Splitting of the web	Feed too high	Reduce feed to optimum rate
	Insufficient initial clearance	Regrind to correct specification
	Excessive web thinning	Regrind to correct specification
	Heavy impact at point of drill	Avoid impact at the point of drill. Take care with taper shank drills when inserting/ ejecting from spindle
Worn outer corner	Excessive speed	Reduce speed to optimum - may be able to increase feed
Broken outer corners	Unstable component set up	Reduce movement in the component
Chipped cutting lips	Excessive initial clearance	Regrind to correct specification
Breakage at flute run out	Choking of flutes	Adopt a peck/series drilling concept
	Drill slipping	Ensure the drill is held securely in the chuck and spindle
Spiral finish in hole	Insufficient feed	Increase feed
	Bad positional accuracy	Use a spot drill before drilling
Hole size too large	Incorrect point geometry	Check point geometry
	Ineffective swarf clearance	Adjust speed, feed and peck length to achieve more manageable swarf



SOLID CARBIDE & HSS DRILLS – TECHNICAL INFO

Hole Size / Achievable Hole Tolerances

As geometric, substrate and coating configurations become more advanced, the ability of a drill to produce a more accurate hole size increases. In general, a standard geometry tool will achieve a hole

size to H12. However as the configuration of the drill becomes more complex the achievable hole size, under favorable conditions, can be as good as H8.

To offer a better insight, listed below are the product types and their achievable hole tolerances:

HSS General Purpose drills – H12

HSS / HSCo Parabolic Flute Deep Hole Drills (PFX) – H10

HSS / HSCo High performance TiN/ TiAlN coated (ADX) – H9

Solid Carbide High Performance TiN / TiAlN coated (CDX, Force) – H8

Nominal Hole Diameter (mm)

Ø [mm]	H8	H9	H10	H12
≤ 3	0 / +0.014	0 / +0.025	0 / +0.040	0 / +0.100
> 3 ≤ 6	0 / +0.018	0 / +0.030	0 / +0.048	0 / +0.120
> 6 ≤ 10	0 / +0.022	0 / +0.036	0 / +0.058	0 / +0.150
> 10 ≤ 18	0 / +0.027	0 / +0.043	0 / +0.070	0 / +0.180
> 18 ≤ 30	0 / +0.033	0 / +0.052	0 / +0.084	0 / +0.210

Nominal Hole Diameter (inches)

Ø [inch]	H8	H9	H10	H12
≤ .1181	0 / +0.0006"	0 / +0.0010"	0 / +0.0016"	0 / +0.0040"
>.1181≤.2362	0 / +0.0007"	0 / +0.0012"	0 / +0.0019"	0 / +0.0048"
>.2362≤.3937	0 / +0.0009"	0 / +0.0015"	0 / +0.0023"	0 / +0.0059"
>.3937≤.7087	0 / +0.0011"	0 / +0.0017"	0 / +0.0028"	0 / +0.0071"
>.7087≤1.1811	0 / +0.0013"	0 / +0.0021"	0 / +0.0033"	0 / +0.0083"

In view of the ability of some drills to produce a much tighter hole tolerance, due consideration should be given to drilled holes which are subject to secondary operations, eg. tapping, reaming. The diameter

of the drill will need to be increased from what is recommended to account for the fact that the hole size produced will be smaller.

Optimizing the Drilling Operation / Troubleshooting

Drill Selection

Use the shortest drill the application will permit in order to achieve maximum tool rigidity.

HOLDERS

Tool holders and collets must provide good concentricity between the drill and the machine spindle. Use a positive back stop to prevent the tool from backing up into the holder. Never clamp the tool over the flutes or over-tighten the holder. Static runout in the tool assembly must be accurately checked and maintained.

Workpiece

A secure and rigid workpiece to minimize deflection is needed, particularly on through-hole applications.

Coolants

Coolants are recommended when drilling mild steel and high temperature alloys. The purpose of the coolant media is to direct the chips away from the cutting tool and workpiece. Excessive coolant pressure and/or too much volume can negatively affect performance. When using coolant fed drills, the coolant pressure that is required should be higher than normal. Suggested pressure for coolant fed drills is minimally 10.3 bar or 150 PSI. As the diameter of the drill is reduced, the higher the pressure. This is to assist the chip in evacuating from a more confined area.



SOLID CARBIDE & HSS DRILLS – TECHNICAL INFO

Drilling Troubleshooting Guide

Problem	Solution
Wear on Outer Corners	Reduce cutting speed
	Increase feed (IPR)
	Improve direction of coolant flow
	Increase coolant pressure
	Add corner break
Chipping of Chisel Edge	Check accuracy of drill runout
	Check workpiece clamping accuracy and movement
	Check point centrality and lip height
	Increase feed rate
Chipping of Cutting Lips	Check accuracy of drill runout
	Check workpiece clamping accuracy and movement
	Reduce speed
	Reduce point clearance
	Increase hone
Cracking of Lands	Check movement of workpiece
	Increase back taper
	Check accuracy of drill runout
	Chip packing; increase flute form opening or peck drill (HSS or HSCO only)
	Slow down helix, horizontal drilling
	Increase feed
	When spot drilling, reduce feed
	Improve direction of coolant flow
Increase coolant pressure	
Oversize Hole	Increase speed, reduce feed
	Check workpiece clamping accuracy and movement
	Check accuracy of drill runout
	Chip packing, increase flute form opening or peck drill (HSS or HSCO only)
	Check point centrality and lip height
Undersize Hole	Improve direction of coolant flow
	Reduce cutting speed, increase feed
	Check drill diameter
Hole Not Round	Check accuracy of drill runout
	Check workpiece clamping accuracy and movement
	Check point centrality and lip height
	Chip packing, increase flute form opening or peck drill (HSS or HSCO only)
Drill Breakage	Chip packing, increase flute form opening or peck drill (HSS or HSCO only)
	Check workpiece clamping accuracy and movement
	Check accuracy of drill runout
	Reduce feed rate, increase feed rate
	Improve direction of coolant flow
	Increase coolant pressure



GENERAL – TECHNICAL INFO

	Grade	Hardness (HV10)	C %	W %	Mo %	Cr %	V %	Co %	Tool Material
	M2	810 – 850	0.9	6.4	5.0	4.2	1.8	–	HSS
	M35	830 – 870	0.93	6.4	5.0	4.2	1.8	4.8	HSCO
	M42	870 – 960	1.08	1.5	9.4	3.9	1.2	8.0	

Properties	HSS materials	Carbide materials	K10/30F (often used for solid tools)
Hardness [HV30]	800-950	1300 – 1800	1600
Density [g/cm ³]	8.0 – 9.0	7.2 – 15	14.45
Compressive strength [N/mm ²]	3000 – 4000	3000 – 8000	6250
Flexural strength, (bending) [N/mm ²]	2500 – 4000	1000 – 4700	4300
Heat resistance [°C]	550	1000	900
E-module [KN/mm ²]	260 – 300	460 – 630	580
Grain size [µm]	–	0.2 – 10	0.8

The combination of hard particle (WC) and binder metal (Co) give the following changes in characteristics.

Characteristic	Higher WC content give	Higher Co content give
Hardness	Higher hardness	Lower hardness
Compressive strength [CS]	Higher CS	Lower CS
Bending strength [BS]	Lower BS	Higher BS

Grain size also influences the material properties. Small grain sizes means higher hardness and coarse grains give more toughness.

Surface treatment / Coating properties examples

Surface Treatments	Colour	Coating material	Hardness [HV]	Thickness [µm]	Coating structure	Frict. coeff. against steel	Max. appl. temp. [°C]
	Dark grey	Fe ₃ O ₄	400	Max. 5	Conversion into the surface	–	550
	Bronze	Fe ₃ O ₄	400	Max. 5	Conversion into the surface	–	550
	Gold	TiN	2300	1 – 4	Mono-layer	0.4	600
	Black grey	TiAlN	3300	3	Nano structured	0.3 – 0.35	900



GENERAL – TECHNICAL INFO

Industry Standard tolerances For Shafts & Holes

Tolerance values are shown in Microns (μm)

Formula for Microns ...1 $\mu\text{m} = 0.001 \text{ mm} / 0.000039''$

Tolerance	Diameter [mm]							
	> 1 ≤ 3	> 3 ≤ 6	> 6 ≤ 10	> 10 ≤ 18	> 18 ≤ 30	> 30 ≤ 50	> 50 ≤ 80	> 80 ≤ 120
	Diameter [inch]							
	> 0.039" ≤ 0.118"	> 0.118" ≤ 0.236"	> 0.236" ≤ 0.394"	> 0.394" ≤ 0.709"	> 0.709" ≤ 1.181"	> 1.181" ≤ 1.968"	> 1.968" ≤ 3.149"	> 3.149" ≤ 4.724"
	Tolerance values [μm]							
e8	-14 / -28	-20 / -38	-25 / -47	-32 / -59	-40 / -73	-50 / -89	-60 / -106	-72 / -126
f6	-6 / -12	-10 / -18	-13 / -22	-16 / -27	-20 / -33	-25 / -41	-30 / -49	-36 / -58
f7	-6 / -16	-10 / -22	-13 / -28	-16 / -34	-20 / -41	-25 / -50	-30 / -60	-36 / -71
h6	0 / -6	0 / -8	0 / -9	0 / -11	0 / -13	0 / -16	0 / -19	0 / -22
h7	0 / -10	0 / -12	0 / -15	0 / -18	0 / -21	0 / -25	0 / -30	0 / -35
h8	0 / -14	0 / -18	0 / -22	0 / -27	0 / -33	0 / -39	0 / -46	0 / -54
h9	0 / -25	0 / -30	0 / -36	0 / -43	0 / -52	0 / -62	0 / -74	0 / -87
h10	0 / -40	0 / -48	0 / -58	0 / -70	0 / -84	0 / -100	0 / -120	0 / -140
h11	0 / -60	0 / -75	0 / -90	0 / -110	0 / -130	0 / -160	0 / -190	0 / -220
h12	0 / -100	0 / -120	0 / -150	0 / -180	0 / -210	0 / -250	0 / -300	0 / -350
k10	+40 / 0	+48 / 0	+58 / 0	+70 / 0	+84 / 0	+100 / 0	+120 / 0	+140 / 0
k12	+100 / 0	+120 / 0	+150 / 0	+180 / 0	+210 / 0	+250 / 0	+300 / 0	+350 / 0
m7	+2 / +12	+4 / +16	+6 / +21	+7 / +25	+8 / +29	+9 / +34	+11 / +41	+13 / +48
js14	+/-125	+/-150	+/-180	+/-215	+/-260	+/-310	+/-370	+/-435
js16	+/-300	+/-375	+/-450	+/-550	+/-650	+/-800	+/-950	+/-1100
H7	+10 / 0	+12 / 0	+15 / 0	+18 / 0	+21 / 0	+25 / 0	+30 / 0	+35 / 0
H8	+14 / 0	+18 / 0	+22 / 0	+27 / 0	+33 / 0	+39 / 0	+46 / 0	+54 / 0
H9	+25 / 0	+30 / 0	+36 / 0	+43 / 0	+52 / 0	+62 / 0	+74 / 0	+87 / 0
H12	+100 / 0	+120 / 0	+150 / 0	+180 / 0	+210 / 0	+250 / 0	+300 / 0	+350 / 0
P9	-6 / -31	-12 / -42	-15 / -51	-18 / -61	-22 / -74	-26 / -86	-32 / -106	-37 / -124
S7	-13 / -22	-15 / -27	-17 / -32	-21 / -39	-27 / -48	-34 / -59	-42 / -72	-58 / -93



GENERAL – TECHNICAL INFO

Table of Cutting Speeds

		Vc															
m/min.		5	8	10	15	20	25	30	40	50	60	70	80	90	100	110	150
SFM (feet/min.)		16	26	32	50	66	82	98	130	165	197	230	262	296	330	362	495
Ø		RPM															
mm	inch																
1.00	–	1592	2546	3183	4775	6366	7958	9549	12732	15916	19099	22282	25465	28648	31831	35014	47747
1.50	–	1061	1698	2122	3183	4244	5305	6366	8488	10610	12732	14854	16977	19099	21221	23343	31831
2.00	–	796	1273	1592	2387	3183	3979	4775	6366	7958	9549	11141	12732	14324	15916	17507	23873
2.50	–	637	1019	1273	1910	2546	3183	3820	5093	6366	7639	8913	10186	11459	12732	14006	19099
3.00	–	531	849	1061	1592	2122	2653	3183	4244	5305	6366	7427	8488	9549	10610	11671	15916
3.18	1/8	500	801	1001	1501	2002	2502	3003	4004	5005	6006	7007	8008	9009	10010	11011	15015
3.50	–	455	728	909	1364	1819	2274	2728	3638	4547	5457	6366	7276	8185	9095	10004	13642
4.00	–	398	637	796	1194	1592	1989	2387	3183	3979	4775	5570	6366	7162	7958	8754	11937
4.50	–	354	566	707	1061	1415	1768	2122	2829	3537	4244	4951	5659	6366	7074	7781	10610
4.76	3/16	334	535	669	1003	1337	1672	2006	2675	3344	4012	4681	5350	6018	6687	7356	10031
5.00	–	318	509	637	955	1273	1592	1910	2546	3183	3820	4456	5093	5730	6366	7003	9549
6.00	–	265	424	531	796	1061	1326	1592	2122	2653	3183	3714	4244	4775	5305	5836	7958
6.35	1/4	251	401	501	752	1003	1253	1504	2005	2506	3008	3509	4010	4511	5013	5514	7519
7.00	–	227	364	455	682	909	1137	1364	1819	2274	2728	3183	3638	4093	4547	5002	6821
7.94	5/16	200	321	401	601	802	1002	1203	1604	2004	2405	2806	3207	3608	4009	4410	6013
8.00	–	199	318	398	597	796	995	1194	1592	1989	2387	2785	3183	3581	3979	4377	5968
9.00	–	177	283	354	531	707	884	1061	1415	1768	2122	2476	2829	3183	3537	3890	5305
9.53	3/8	167	267	334	501	668	835	1002	1336	1670	2004	2338	2672	3006	3340	3674	5010
10.00		159	255	318	477	637	796	955	1273	1592	1910	2228	2546	2865	3183	3501	4775
11.11	7/16	143	229	287	430	573	716	860	1146	1433	1719	2006	2292	2579	2865	3152	4298
12.00		133	212	265	398	531	663	796	1061	1326	1592	1857	2122	2387	2653	2918	3979
12.70	1/2	125	201	251	376	501	627	752	1003	1253	1504	1754	2005	2256	2506	2757	3760
14.00		114	182	227	341	455	568	682	909	1137	1364	1592	1819	2046	2274	2501	3410
14.29	9/16	111	178	223	334	446	557	668	891	1114	1337	1559	1782	2005	2228	2450	3341
15.00	–	106	170	212	318	424	531	637	849	1061	1273	1485	1698	1910	2122	2334	3183
15.88	5/8	100	160	200	301	401	501	601	802	1002	1203	1403	1604	1804	2004	2205	3007
16.00	–	99	159	199	298	398	497	597	796	995	1194	1393	1592	1790	1989	2188	2984
17.46	11/16	91	146	182	273	365	456	547	729	912	1094	1276	1458	1641	1823	2005	2735
18.00	–	88	141	177	265	354	442	531	707	884	1061	1238	1415	1592	1768	1945	2653
19.05	3/4	84	134	167	251	334	418	501	668	835	1003	1170	1337	1504	1671	1838	2506
20.00	–	80	127	159	239	318	398	477	637	796	955	1114	1273	1432	1592	1751	2387
24.00	–	66	106	133	199	265	332	398	531	663	796	928	1061	1194	1326	1459	1989
25.00	–	64	102	127	191	255	318	382	509	637	764	891	1019	1146	1273	1401	1910
27.00	–	59	94	118	177	236	295	354	472	589	707	825	943	1061	1179	1297	1768
30.00	–	53	85	106	159	212	265	318	424	531	637	743	849	955	1061	1167	1592
32.00	–	50	80	99	149	199	249	298	398	497	597	696	796	895	995	1094	1492
36.00	–	44	71	88	133	177	221	265	354	442	531	619	707	796	884	973	1326
40.00	–	40	64	80	119	159	199	239	318	398	477	557	637	716	796	875	1194
50.00	–	32	51	64	95	127	159	191	255	318	382	446	509	573	637	700	955



GENERAL – TECHNICAL INFO

Hardness and Tensile Strength

HV	HRC	HB	Tensile Strength	
			[N/mm ²]	[Tons/sq. in.]
940	68	–	–	–
900	67	–	–	–
864	66	–	–	–
829	65	–	–	–
800	64	–	–	–
773	63	–	–	–
745	62	–	–	–
720	61	–	–	–
698	60	–	–	–
675	59	–	–	–
655	58	–	2200	142
650	–	618	2180	141
640	–	608	2145	139
639	57	607	2140	138
630	–	599	2105	136
620	–	589	2070	134
615	56	584	2050	133
610	–	580	2030	131
600	–	570	1995	129
596	55	567	1980	128
590	–	561	1955	126
580	–	551	1920	124
578	54	549	1910	124
570	–	542	1880	122
560	53	532	1845	119
550	–	523	1810	117
544	52	517	1790	116
540	–	513	1775	115
530	–	504	1740	113
527	51	501	1730	112
520	–	494	1700	110
514	50	488	1680	109
510	–	485	1665	108
500	–	475	1630	105
497	49	472	1620	105
490	–	466	1595	103
484	48	460	1570	102
480	–	456	1555	101
473	47	449	1530	99
470	–	447	1520	98
460	–	437	1485	96
458	46	435	1480	96
450	–	428	1455	94
446	45	424	1440	93
440	–	418	1420	92

HV	HRC	HB	Tensile Strength	
			[N/mm ²]	[Tons/sq. in.]
434	44	413	1400	91
423	43	402	1360	88
413	42	393	1330	86
403	41	383	1300	84
392	40	372	1260	82
382	39	363	1230	80
373	38	354	1200	78
364	37	346	1170	76
355	36	337	1140	74
350	–	333	1125	73
345	35	328	1110	72
340	–	323	1095	71
336	34	319	1080	70
330	–	314	1060	69
327	33	311	1050	68
320	–	304	1030	67
317	32	301	1020	66
310	31	295	995	64
302	30	287	970	63
300	–	285	965	62
295	–	280	950	61
293	29	278	940	61
290	–	276	930	60
287	28	273	920	60
285	–	271	915	59
280	27	266	900	58
275	–	261	880	57
272	26	258	870	56
270	–	257	865	56
268	25	255	860	56
265	–	252	850	55
260	24	247	835	54
255	23	242	820	53
250	22	238	800	52
245	–	233	785	51
243	21	231	780	50
240	–	228	770	50
235	–	223	755	49
230	–	219	740	48
225	–	214	720	47
220	–	209	705	46
215	–	204	690	45
210	–	199	675	44
205	–	195	660	43
200	–	190	640	41



CUTTING FLUIDS



M200-1



M200 no. 1 Blue, Cutting Fluid for Heavy Machining

A high performance cutting oil for difficult operations, such as tapping, broaching and drilling by hand or with a pillar drill. For increased tool life and improved surface finishes. First choice recommendation for high strength steel, stainless steel and super alloys.

Product	Nr.
M2000.25NR.1BLUE	1/4 Ltr. 12x
M2001.0NR.1BLUE	1 Ltr.
M2005.0NR.1BLUE	5 Ltr.
M20020.0NR.1BLUE	20 Ltr.

M200-2



M200 no. 2 Red, Cutting Fluid for Non-Ferrous Metals

A neat oil for machining operations requiring chip removal in aluminium and its alloys. For lubrication and cooling to promote long tool life and ensure excellent surface finish. Low impact on the environment due to excellent anti-mist properties, high oxidation stability and low odours.

Product	Nr.
M2000.25NR.2RED	1/4 Ltr. 12x
M2001.0NR.2RED	1 Ltr.
M2005.0NR.2RED	5 Ltr.



M200-3



M200 no. 3 Green, Cutting Fluid for General Purpose Machining

A high performance cutting oil with extreme pressure (EP) additives to provide longer tool life. For general cutting or forming operations, such as tapping, broaching and drilling in steel or cast steel and stainless steel.

Product	Nr.
M2000.25NR.3GREEN	1/4 Ltr. 12x
M2001.0NR.3GREEN	1 Ltr.
M2005.0NR.3GREEN	5 Ltr.



DORMER PRAMET



REACH FOR THE SKIES

We've added hundreds of new products to our global assortment of cutting tools, with a specific focus on airframe and assembly applications. All are featured in a new publication, which is now available to download. **Simply Reliable.**



AIRFRAME & ASSEMBLY

**REAMERS
AND COUNTERSINKS**





HOLEMAKING – GENERAL CONTENT

6		WMG & ISO 13399
12	DRILLS	INSTRUCTIONS
15		SOLID CARBIDE DRILLS
66		HSS DRILLS
176		TECHNICAL INFORMATION
186		CUTTING FLUIDS
190		REAMERS AND COUNTERSINKS
264	INDEXABLE DRILLS	INSTRUCTIONS
271		HYDRA DRILLS
297		TECHNICAL INFORMATION
307		INDEXABLE DRILLS
327		TECHNICAL INFORMATION
350	BORING SYSTEMS	INSTRUCTIONS
359		BORING HEADS
376		BORING ACCESSORIES
381		INSERTS
404		ARBORS
418		BORING KITS
429		TECHNICAL INFORMATION



REAMERS AND COUNTERSINKS – PAGE OVERVIEW

1 B400



Carbide Straight Shank Machine Reamer with H7 Accuracy, Bright Finish

Designed to provide a finish within the limits of H7 accuracy. For superior performance and extended tool life when reaming hard and abrasive materials. The spiral flute design, with extremely unequal spacing between the flutes, reduces vibration and improves hole roundness, size and surface finish.

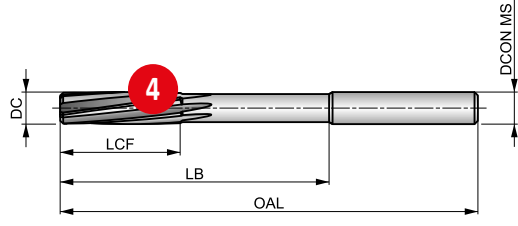

HM	Bright	DIN 8093
R	B	
H7		

Workpiece material group suitability, starting values for cutting speed (m/min) and feed Alpha Code. Tables with feed per revolution can be found starting from page XY.

P1.1	P1.2	P1.3	P2.1	P2.2	P2.3	P3.1	P3.2	P3.3	P4.1	P4.2	P4.3	M1.1	M1.2
■ 23 B	■ 26 B	■ 27 B	■ 20 B	■ 18 B	■ 16 C	■ 16 B	■ 13 B	■ 11 C	■ 10 B	■ 8 C	■ 7 C	■ 10 C	■ 8 C
■ 9 C	■ 7 C	■ 16 B	■ 20 D	■ 15 D	■ 11 D	■ 21 D	■ 17 D	■ 14 D	■ 18 D	■ 14 D	■ 11 D	■ 19 D	■ 15 D
■ 11 D	■ 60 D	■ 45 D	■ 30 D	■ 38 D	■ 35 D	■ 25 D	■ 64 E	■ 38 E	■ 19 E	■ 35 C	■ 30 C		

DCON MS tolerance h6; DC >= 14 mm Carbide Tipped.

Product	DC	OAL	LCF	LB	NOF	DCON MS
	[mm]	[mm]	[mm]	[mm]		[mm]
B4001.0	1.00	34.0	5.5	15.00	3	1.00
B4001.2	1.20	38.0	7.5	16.50	3	1.20
B4001.4	1.40	40.0	8.0	18.00	3	1.50
B4001.5	1.50	40.0	8.0	18.00	3	1.50
B4001.6	1.60	43.0	9.0	20.00	3	1.60
B4001.8	1.80	46.0	10.0	22.00	4	1.80
B4002.0	2.00	49.0	11.0	24.00	4	2.00
B4002.2	2.20	53.0	12.0	25.00	4	2.20
B4002.5	2.50	57.0	14.0	27.00	4	2.50
B4003.0	3.00	61.0	15.0	30.00	6	3.00
B4003.2	3.20	65.0	16.0	37.00	6	3.20

Product	DC	OAL	LCF	LB	NOF	DCON MS
	[mm]	[mm]	[mm]	[mm]		[mm]
B4004.5	4.50	80.0	21.0	52.00	6	4.50
B4005.0	5.00	86.0	23.0	58.00	6	5.00
B4005.5	5.50	93.0	26.0	57.00	6	5.60
B4006.0	6.00	93.0	26.0	57.00	6	5.60
B4006.5	6.50	101.0	28.0	65.00	6	6.30
B4007.0	7.00	109.0	31.0	73.00	6	7.10
B4008.0	8.00	117.0	33.0	81.00	6	8.00
B4009.0	9.00	125.0	36.0	85.00	6	9.00
B4010.0	10.00	133.0	38.0	93.00	6	10.00
B4012.0	12.00	151.0	44.0	111.00	6	10.00
B4014.0	14.00	160.0	47.0	115.00	6	12.50
B4016.0	16.00	170.0	52.0	125.00	6	12.50

Pos.	Description
1	Designation of drill
2	Product description
3	Illustrative picture
4	Schematic drawing of tool

Pos.	Description
5	Product features
6	Material group recommendations incl. speed and feed guidance
7	Product code
8	Product dimensions



REAMERS AND COUNTERSINKS – ICONS OVERVIEW

General icons

	Primary use
	Possible use

Achievable Hole Tolerance Zone (TCHA)

	H7 – Industry Standard Hole Tolerance Zone (based on diameter range)		k11 – Industry Standard Tool Tolerance Zone (based on diameter range)
	High Precision Hole Tolerance Zone (based on diameter range)		

Application Angle

	100° Countersink		20° Conical Drill		82° Countersink
	180° Counterbore		60° Countersink		90° Countersink

Basic Standard Group (BSG)

	ANSI – Tap Standards		DIN 219 – Shell Reamer Standards		DIN 8050 – Parallel Shank Reamer Standards
	BS 328 – Drills and Reamers Standards		DIN 311 – Morse Taper Shank Bridge Reamer Standards		DIN 8051 – Morse Taper Shank Reamer Standards
	DIN 206 – Hand Reamer Standards		DIN 334 C – Straight Shank Countersink Standards		DIN 8093 – Straight Shank Reamer Standards
	DIN 208 – Morse Taper Shank Chucking Reamer Standards		DIN 334 D – Morse Taper Shank Countersink Standards		DIN 8094 – Morse Taper Shank Reamer Standards
	DIN 212 – Machine Reamer Standards		DIN 335 A – Straight Shank Countersink Standards		DIN 9 – Taper Pin Reamer Standards
	DIN 217 – Shell Reamer Arbor Standards		DIN 335 C – Straight Shank Countersink Standards		Dormer Standards
	DIN 2179 – Parallel Shank Taper Pin Reamer Standards		DIN 335 D – Morse Taper Shank Countersink Standards		
	DIN 2180 – Morse Taper Shank Taper Pin Reamer Standards		DIN 373 – Counterbore Standards		

Coating

	Aluminium Titanium Carbon Nitride Coating		Combination Bright and Steam Oxide		Titanium Aluminium Nitride Coating
	Bright (uncoated)		Steam and Bronze Oxide Surface Treatment		Titanium Nitride Coated

Cutting Direction







	Right Hand Rotation / Cutting
--	-------------------------------

Material Code (BMC)

	Hard Material (Solid Carbide)		High Speed Steel Tool Material
	High Speed Cobalt Steel Tool Material		



REAMERS AND COUNTERSINKS – ICONS OVERVIEW

Reamer Form		Shank	
A	DIN Form A – Straight Flute $\leq \varnothing 3.5\text{mm}$	 Cylindrical Shank / Straight Shank	 Cylindrical Shank with Tang
B	DIN Form B – Spiral Flute $\leq \varnothing 3.5\text{mm}$	 Cylindrical Shank with 3flat	 DIN 6535 HA Cylindrical Shank
E	DIN Form C – Straight Flute $\geq \varnothing 4.0\text{mm}$	 Cylindrical Shank with Hex	 Morse Taper Shank
		 Cylindrical Shank with Square	



Taper Gradient (Rate of Taper)

1:48 	Taper Gradient (1/4" per foot taper)	1:50 	Taper Gradient (1 mm per 50 mm taper)
---	--------------------------------------	--	---------------------------------------



REAMERS AND COUNTERSINKS – NAVIGATOR TOOL MATERIALS







Tool materials

High Speed Steel		A medium-alloyed high speed steel that has good machinability and good performance. HSS exhibits hardness, toughness and wear resistance characteristics that make it attractive in a wide range of applications, for example in drills and taps.
Cobalt High Speed Steel		This high speed steel contains cobalt for increased hot hardness. The composition of HSCo is a good combination of toughness and hardness. It has good machinability and good wear resistance, which makes it usable for drills, taps, milling cutters and reamers.

Carbide materials

Carbide Materials (or Hard Materials)		<p>A sintered powder metallurgy substrate, consisting of a metallic carbide composite with binder metal. The most central raw material is tungsten carbide (WC). Tungsten carbide contributes to the hardness of the material. Tantalum carbide (TaC), titanium carbide (TiC) and niobium carbide (NbC) complements WC and adjusts the properties to what is desired. These three materials are called cubic carbides. Cobalt (Co) acts as a binder and keeps the material together.</p> <p>Carbide materials are often characterised by high compression strength, high hardness and therefore high wear resistance, but also by limited flexural strength and toughness. Carbide is used in taps, reamers, milling cutters, drills and thread milling cutters.</p>
--	---	--

Surface Coatings

Titanium Nitride (TiN)		Titanium Nitride is a gold coloured ceramic coating applied by physical vapour deposition (PVD). High hardness combined with low friction properties ensures considerably longer tool life, or alternatively, better cutting performance from tools which have not been coated. TiN coating is used mainly for drills and taps.
Aluminium Titanium Carbon Nitride (AlTiCN)		Aluminium Titanium Carbon-Nitride (AlTiCN) is a PVD coating which was specifically engineered to meet the rigorous requirements of the medical device industry. It is however equally applicable to certain cutting tool operations due to a high quality thin-film technology, with excellent micro-hardness and adhesion characteristics.
Titanium Aluminium Nitride coatings (TiAlN)		Titanium Aluminium Nitride is a multi layer ceramic coating applied by PVD coating technology, which exhibits high toughness and oxidation stability. These properties make it ideal for higher speeds and feeds, while at the same time improving tool life. TiAlN is used in drilling, tapping, and milling applications and can be suitable for use when machining without coolant.
Bright (uncoated)		Bright finish (uncoated surface) improves chip flow in soft or non-ferrous materials while maintaining sharp cutting edges.
Combination Bright and Steam Tempered		Combination of bright and steam tempering can be effective, as the blue oxide more porous surface acts to retain and pull cutting fluid into the hole while the bright surface assists in chip evacuation. This combination is achieved by grinding the bright surface after tempering.
Combination Steam and Bronze Tempered Surface Treatment		Combination of steam and bronze tempering can be effective, as the blue oxide more porous surface acts to retain and pull cutting fluid into the hole while the bronze surface assists in chip evacuation. Both surface treatments add a degree of surface protection to the tool. These combinations are achieved by using two different tempering cycles.



Material code (BMC)	HM	HM	HM	HM	HM	HSS	HSS	HSS	HSS-E	HSS	HSS	HSS	HSS
Coating	Bright	Bright	Bright	Bright	Bright	Bright ST	Bright		Bright ST	Bright ST	Bright ST	Bright	ST Bronze
Basic standard group (BSG)	DIN 8093	DIN 8093	DIN 8050	DIN 8094	DIN 8051	DIN 206	DORMER	DORMER	BS 328	BS 328	DIN 9	DIN 9	ANSI
Hand (Cutting direction)	R	R	R	R	R	R	R		R	R	R	R	R
Shank													
Application angle													
Reamer form	B	B	A	B	A	B			B	A	A	B	
Achievable hole tolerance (TCHA)	H7	$\begin{matrix} \phi.95-5.5 \\ +0.004 \\ \phi5.51-12 \\ +0.005 \end{matrix}$	H7	H7	H7	H7			H7				
Taper gradient - millimeter (Rate of taper)										1:48	1:50	1:50	
Product Family Code	B400	B481	B441	B411	B442	B100	B334	B335	B901	B301	B903	B952	B122
	1.00 - 20.00	0.98 - 12.05	10.00 - 20.00	5.00 - 30.00	10.00 - 20.00	1.50 - 50.00	N000 - N16	N000BLADES - N16NUT	1.50 - 1/2	1/16 - 1/2	1.50 - 20.00	1.20 - 50.00	3/8 - 1.1/16
	200	201	203	204	205	206	208	209	210	211	212	213	214
P	P1	■	■	■	■	■	■	■	■	■	■	■	■
	P2	■	■	■	■	■	■	■	■	■	■	■	■
	P3	■	■	■	■	■	■	■	■	■	■	■	■
	P4	■	■	■	■	■	■	■	■	■	■	■	■
M	M1	■	■	■	■	■	■	■	■	■	■	■	■
	M2	■	■	■	■	■	■	■	■	■	■	■	■
	M3												
	M4												
K	K1	■	■	■	■	■	■	■	■	■	■	■	■
	K2	■	■	■	■	■	■	■	■	■	■	■	■
	K3	■	■	■	■	■	■	■	■	■	■	■	■
	K4												
	K5	■	■	■	■	■	■	■	■	■	■	■	■
N	N1	■	■	■	■	■	■	■	■	■	■	■	■
	N2	■	■	■	■	■	■	■	■	■	■	■	■
	N3	■	■	■	■	■	■	■	■	■	■	■	■
	N4	■	■	■	■	■	■	■	■	■	■	■	■
	N5												
S	S1												
	S2												
	S3												
	S4												
H	H1												
	H2												
	H3												
	H4												

■ Primary use ■ Possible use



	HSS-E	HSS-E	HSS-E	HSS-E	HSS-E	HSS-E	HSS	HSS-E	HSS-E	HSS-E		HM	HSS	HSS
	Bright	Bright	Bright	Bright	Bright	Bright ST	Bright ST	Bright	Bright ST	Bright		Bright	Bright	TIN
	DIN 2179	DIN 212	DIN 212	DIN 212	DIN 208	BS 328	DIN 311	DIN 2180	DIN 219	DIN 217		DIN 335C	DIN 334C	DIN 334C
		B	B	E	B	B		B						
	H7		$\begin{matrix} \phi 95-5.5 \\ +0.004 \\ \phi 5.51-12 \\ +0.005 \end{matrix}$	H7	H7	H7	k11		H7					
	1:50							1:50						
	B953	B180	B170	B157	B161	B101	B121	B954	B955	B956	B957	G400	G135	G335
	1.00 - 12.00	1.50 - 20.00	0.98 - 12.00	2.00 - 20.00	3.00 - 50.00	3.00 - 2"	10.00 - 30.00	5.00 - 30.00	25.00 - 80.00	13.00 - 40.00	N3DRIVER - N9WASHER	6.30 - 31.00	6.30 - 25.00	6.30 - 25.00
	215	216	218	220	221	222	224	225	226	227	228	229	230	231
P1	■	■	■	■	■	■	■	■	■			■	■	■
P2	■	■	■	■	■	■	■	■	■			■	■	■
P3	■	■	■	■	■	■	■	■	■			■	■	■
P4	■	■	■	■	■	■	■	■	■			■	■	■
M1	■	■	■	■	■	■		■	■			■	■	■
M2	■	■	■	■	■			■	■			■	■	■
M3												■		■
M4												■		
K1	■	■	■		■	■	■	■	■			■	■	■
K2	■	■	■		■	■	■	■	■			■	■	■
K3	■	■	■		■	■	■	■	■			■	■	■
K4												■	■	■
K5												■	■	■
N1	■	■	■	■	■	■	■	■	■			■	■	■
N2	■	■	■	■	■	■	■	■	■			■	■	■
N3	■	■	■	■	■	■	■	■	■			■	■	■
N4	■	■	■		■	■	■	■	■			■	■	■
N5														
S1												■		
S2												■		
S3												■		
S4												■		
H1												■		
H2												■		
H3												■		
H4												■		

■ Primary use ■ Possible use



Material code (BMC)	HSS	HSS	HSS	HSS-E	HSS	HSS	HSS	HSS	HSS	HSS-E	HSS-E	HSS
Coating	Bright	Bright	Bright	Bright	Bright	TiAlN	Bright	TiAlN	Bright	AlTiCN	Bright	Bright
Basic standard group (BSG)	DIN 334D	DIN 335C	DORMER	DORMER	DIN 335C	DIN 335C	DIN 335C	DIN 335C	DIN 335C	DIN 335C	DORMER	DORMER
Hand (Cutting direction)	R	R	R	R	R	R	R	R	R	R	R	R
Shank												
Application angle	60°	82°	90°	90°	90°	90°	90°	90°	90°	90°	90°	90°
Reamer form												
Achievable hole tolerance (TCHA)												
Taper gradient - millimeter (Rate of taper)												
Product Family Code	G137	G154	G129	G149	G136	G560	G106	G506	G142	G570	G107	G600
	16.00 - 80.00	6.30 - 25.00	6.00 - 31.50	5.00 - 50.00	4.30 - 31.00	6.30 - 31.00	6.30 - 50.00	6.30 - 50.00	4.80 - 31.00	6.30 - 31.00	6.30 - 20.50	6.30 - 25.00
P	P1	■	■	■	■	■	■	■	■	■	■	■
	P2	■	■	■	■	■	■	■	■	■	■	■
	P3	■	■	■	■	■	■	■	■	■	■	■
	P4	■	■	■	■	■	■	■	■	■	■	■
M	M1	■	■	■	■	■	■	■	■	■	■	■
	M2	■	■	■	■	■	■	■	■	■	■	■
	M3								■	■	■	■
	M4								■	■	■	■
K	K1	■	■	■	■	■	■	■	■	■	■	■
	K2	■	■	■	■	■	■	■	■	■	■	■
	K3	■	■	■	■	■	■	■	■	■	■	■
	K4						■	■	■	■	■	■
	K5	■	■	■	■	■	■	■	■	■	■	■
N	N1	■	■	■	■	■	■	■	■	■	■	■
	N2	■	■	■	■	■	■	■	■	■	■	■
	N3	■	■	■	■	■	■	■	■	■	■	■
	N4	■	■	■	■	■	■	■	■	■	■	■
	N5											
S	S1											
	S2											
	S3											
	S4											
H	H1											
	H2											
	H3											
	H4											

■ Primary use ■ Possible use

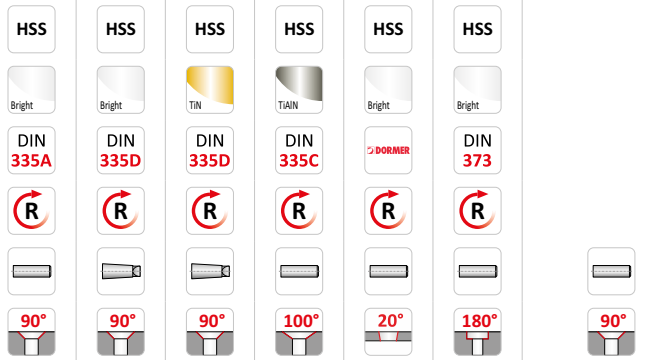

G132	G138	G338	G171	G314	G125	G236
------	------	------	------	------	------	------

8.00 - 20.00	25.00 - 80.00	25.00 - 63.00	6.30 - 25.00	4.00 - 9.00	6.50 - 20.00	Set
--------------	---------------	---------------	--------------	-------------	--------------	-----

244	245	246	247	248	249	250
-----	-----	-----	-----	-----	-----	-----

P1	■	■	■	■	■	
P2	☑	■	■	■	☑	■
P3	☑	☑	■	■	☑	☑
P4	■	☑	■	■	☑	
M1		☑	☑	☑	☑	
M2		☑	☑	☑	☑	
M3	☑					
M4	☑					
K1	■	☑	■	■	☑	☑
K2	☑	☑	■	■	☑	☑
K3	☑	☑	■	■	☑	☑
K4	☑		☑	☑	☑	☑
K5	☑	☑	■	■	☑	☑
N1	☑	☑	■	☑	■	■
N2	■	☑	■	■	☑	☑
N3	☑	■	■	■	■	■
N4	☑	☑	☑	☑	■	☑
N5						
S1						
S2						
S3						
S4						
H1						
H2						
H3						
H4						



B400



Carbide Straight Shank Machine Reamer with H7 Accuracy, Bright Finish

Designed to provide a finish within the limits of H7 hole tolerance. For superior performance and extended tool life when reaming hard and abrasive materials. The spiral flute design, with extremely unequal spacing between the flutes, reduces vibration and improves hole roundness, size and surface finish.

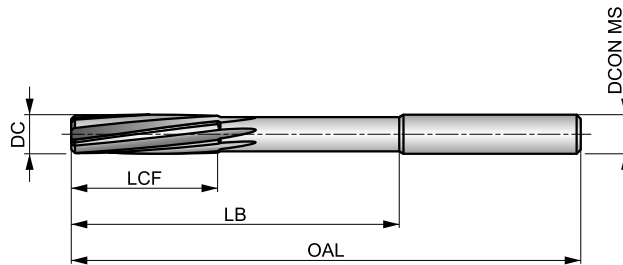

HM	Bright	DIN 8093
R		B
H7		

Workpiece material group suitability, starting values for cutting speed (m/min) and feed Alpha Code. Tables with feed per revolution can be found starting from page 251.

P1.1 ■ 23 B	P1.2 ■ 26 B	P1.3 ■ 27 B	P2.1 ■ 20 B	P2.2 ■ 18 B	P2.3 ■ 16 C	P3.1 ■ 16 B	P3.2 ■ 13 B	P3.3 ■ 11 C	P4.1 ■ 10 B	P4.2 ■ 8 C	P4.3 ■ 7 C	M1.1 ■ 10 C	M1.2 ■ 8 C
M2.1 ■ 19 C	M2.2 ■ 17 C	M2.3 ■ 16 B	K1.1 ■ 20 D	K1.2 ■ 15 D	K1.3 ■ 11 D	K2.1 ■ 21 D	K2.2 ■ 17 D	K2.3 ■ 14 D	K3.1 ■ 18 D	K3.2 ■ 14 D	K3.3 ■ 11 D	K5.1 ■ 19 D	K5.2 ■ 15 D
K5.3 ■ 11 D	N1.1 ■ 60 D	N1.2 ■ 45 D	N1.3 ■ 30 D	N2.1 ■ 38 D	N2.2 ■ 35 D	N2.3 ■ 25 D	N3.1 ■ 64 E	N3.2 ■ 38 E	N3.3 ■ 19 E	N4.1 ■ 35 C	N4.2 ■ 30 C		

DCON MS tolerance h6; DC >= 14 mm Carbide Tipped.

Product	DC [mm]	OAL [mm]	LCF [mm]	LB [mm]	NOF	DCON MS [mm]
B4001.0	1.00	34.0	5.5	15.00	3	1.00
B4001.2	1.20	38.0	7.5	16.50	3	1.20
B4001.4	1.40	40.0	8.0	18.00	3	1.50
B4001.5	1.50	40.0	8.0	18.00	3	1.50
B4001.6	1.60	43.0	9.0	20.00	3	1.60
B4001.8	1.80	46.0	10.0	22.00	4	1.80
B4002.0	2.00	49.0	11.0	24.00	4	2.00
B4002.2	2.20	53.0	12.0	25.00	4	2.20
B4002.5	2.50	57.0	14.0	29.00	4	2.50
B4002.8	2.80	61.0	15.0	33.00	6	3.00
B4003.0	3.00	61.0	15.0	33.00	6	3.00
B4003.2	3.20	65.0	16.0	37.00	6	3.20
B4003.5	3.50	70.0	18.0	42.00	6	3.50
B4004.0	4.00	75.0	19.0	47.00	6	4.00

Product	DC [mm]	OAL [mm]	LCF [mm]	LB [mm]	NOF	DCON MS [mm]
B4004.5	4.50	80.0	21.0	52.00	6	4.50
B4005.0	5.00	86.0	23.0	58.00	6	5.00
B4005.5	5.50	93.0	26.0	57.00	6	5.60
B4006.0	6.00	93.0	26.0	57.00	6	5.60
B4006.5	6.50	101.0	28.0	65.00	6	6.30
B4007.0	7.00	109.0	31.0	73.00	6	7.10
B4008.0	8.00	117.0	33.0	81.00	6	8.00
B4009.0	9.00	125.0	36.0	85.00	6	9.00
B40010.0	10.00	133.0	38.0	93.00	6	10.00
B40012.0	12.00	151.0	44.0	111.00	6	10.00
B40014.0	14.00	160.0	47.0	115.00	6	12.50
B40016.0	16.00	170.0	52.0	125.00	6	12.50
B40018.0	18.00	182.0	56.0	137.00	6	14.00
B40020.0	20.00	195.0	60.0	147.00	6	16.00



B481



Carbide Straight Shank Machine Reamer - 0.01 mm Increments, Bright Finish

Straight shank for high performance on CNC machining. Different increment sizes allows to produce accurate hole sizes and tolerances. Premium carbide tips gives greatly improved performance and extended tool life when reaming hard and abrasive materials. Extremely unequal spacing on the flutes to reduce vibration.

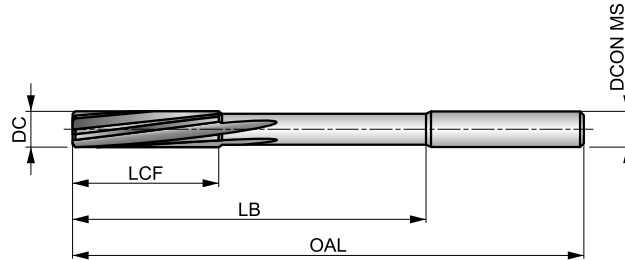

HM	Bright	DIN 8093
R	DIN 6535HA	B
$\varnothing_{.95-5.5}$ $+0.004$ $\varnothing_{5.51-12}$ $+0.005$		

Workpiece material group suitability, starting values for cutting speed (m/min) and feed Alpha Code. Tables with feed per revolution can be found starting from page 251.

P1.1 ■ 23 B	P1.2 ■ 26 B	P1.3 ■ 27 B	P2.1 ■ 20 B	P2.2 ■ 18 B	P2.3 ■ 16 C	P3.1 ■ 16 B	P3.2 ■ 13 B	P3.3 ■ 11 C	P4.1 ■ 10 B	P4.2 ■ 8 C	P4.3 ■ 7 C	M1.1 ■ 10 C	M1.2 ■ 8 C
M2.1 ■ 9 C	M2.2 ■ 7 C	M2.3 ■ 6 B	K1.1 ■ 20 D	K1.2 ■ 15 D	K1.3 ■ 11 D	K2.1 ■ 21 D	K2.2 ■ 17 D	K2.3 ■ 14 D	K3.1 ■ 18 D	K3.2 ■ 14 D	K3.3 ■ 11 D	K5.1 ■ 19 D	K5.2 ■ 15 D
K5.3 ■ 11 D	N1.1 ■ 60 D	N1.2 ■ 45 D	N1.3 ■ 30 D	N2.1 ■ 38 D	N2.2 ■ 35 D	N2.3 ■ 25 D	N3.1 ■ 64 E	N3.2 ■ 38 E	N3.3 ■ 19 E	N4.1 ■ 35 C	N4.2 ■ 30 C		

DCON MS tolerance h6.

Product	DC	OAL	LCF	LB	NOF	DCON MS
	[mm]	[mm]	[mm]	[mm]		[mm]
B4810.98	0.98	50.0	6.0	28.00	3	3.00
B4810.99	0.99	50.0	6.0	28.00	3	3.00
B4811.00	1.00	50.0	6.0	28.00	3	3.00
B4811.01	1.01	50.0	6.0	28.00	3	3.00
B4811.02	1.02	50.0	6.0	28.00	3	3.00
B4811.03	1.03	50.0	6.0	28.00	3	3.00
B4811.48	1.48	50.0	9.0	28.00	3	3.00
B4811.49	1.49	50.0	9.0	28.00	3	3.00
B4811.50	1.50	50.0	9.0	28.00	3	3.00
B4811.51	1.51	50.0	10.0	28.00	3	3.00
B4811.52	1.52	50.0	10.0	28.00	3	3.00
B4811.53	1.53	50.0	10.0	28.00	3	3.00
B4811.98	1.98	50.0	12.0	28.00	4	3.00
B4811.99	1.99	50.0	12.0	28.00	4	3.00
B4812.00	2.00	50.0	12.0	28.00	4	3.00
B4812.01	2.01	50.0	12.0	28.00	4	3.00
B4812.02	2.02	50.0	12.0	28.00	4	3.00
B4812.03	2.03	50.0	12.0	28.00	4	3.00
B4812.48	2.48	60.0	16.0	28.00	4	3.00
B4812.49	2.49	60.0	16.0	28.00	4	3.00
B4812.50	2.50	60.0	16.0	28.00	4	3.00
B4812.51	2.51	60.0	16.0	28.00	4	3.00
B4812.52	2.52	60.0	16.0	28.00	4	3.00
B4812.53	2.53	60.0	16.0	28.00	4	3.00
B4812.97	2.97	65.0	17.0	28.00	6	4.00
B4812.98	2.98	65.0	17.0	28.00	6	4.00
B4812.99	2.99	65.0	17.0	28.00	6	4.00
B4813.00	3.00	65.0	17.0	28.00	6	4.00
B4813.01	3.01	65.0	17.0	28.00	6	4.00
B4813.02	3.02	65.0	17.0	28.00	6	4.00
B4813.03	3.03	65.0	17.0	28.00	6	4.00
B4813.97	3.97	75.0	19.0	28.00	6	4.00
B4813.98	3.98	75.0	19.0	28.00	6	4.00
B4813.99	3.99	75.0	19.0	28.00	6	4.00
B4814.00	4.00	75.0	19.0	28.00	6	4.00
B4814.01	4.01	75.0	19.0	28.00	6	4.00
B4814.02	4.02	75.0	19.0	28.00	6	4.00
B4814.03	4.03	75.0	19.0	28.00	6	4.00
B4814.97	4.97	93.0	23.0	36.00	6	6.00
B4814.98	4.98	93.0	23.0	36.00	6	6.00
B4814.99	4.99	93.0	23.0	36.00	6	6.00
B4815.00	5.00	93.0	23.0	36.00	6	6.00
B4815.01	5.01	93.0	23.0	36.00	6	6.00
B4815.02	5.02	93.0	23.0	36.00	6	6.00
B4815.03	5.03	93.0	23.0	36.00	6	6.00
B4815.97	5.97	93.0	26.0	36.00	6	6.00
B4815.98	5.98	93.0	26.0	36.00	6	6.00
B4815.99	5.99	93.0	26.0	36.00	6	6.00
B4816.00	6.00	93.0	26.0	36.00	6	6.00
B4816.01	6.01	93.0	26.0	36.00	6	6.00
B4816.02	6.02	93.0	26.0	36.00	6	6.00
B4816.03	6.03	93.0	26.0	36.00	6	6.00
B4817.97	7.97	117.0	33.0	36.00	6	8.00
B4817.98	7.98	117.0	33.0	36.00	6	8.00



Product	DC	OAL	LCF	LB	NOF	DCON MS
	[mm]	[mm]	[mm]	[mm]		[mm]
B4817.99	7.99	117.0	33.0	36.00	6	8.00
B4818.00	8.00	117.0	33.0	36.00	6	8.00
B4818.01	8.01	117.0	33.0	36.00	6	8.00
B4818.02	8.02	117.0	33.0	36.00	6	8.00
B4818.03	8.03	117.0	33.0	36.00	6	8.00
B4818.04	8.04	117.0	33.0	36.00	6	8.00
B4819.97	9.97	133.0	38.0	40.00	6	10.00
B4819.98	9.98	133.0	38.0	40.00	6	10.00
B4819.99	9.99	133.0	38.0	40.00	6	10.00
B48110.00	10.00	133.0	38.0	40.00	6	10.00
B48110.01	10.01	133.0	38.0	40.00	6	10.00
B48110.02	10.02	133.0	38.0	40.00	6	10.00

Product	DC	OAL	LCF	LB	NOF	DCON MS
	[mm]	[mm]	[mm]	[mm]		[mm]
B48110.03	10.03	133.0	38.0	40.00	6	10.00
B48110.04	10.04	133.0	38.0	40.00	6	10.00
B48110.05	10.05	133.0	38.0	40.00	6	10.00
B48111.97	11.97	151.0	44.0	45.00	6	12.00
B48111.98	11.98	151.0	44.0	45.00	6	12.00
B48111.99	11.99	151.0	44.0	45.00	6	12.00
B48112.00	12.00	151.0	44.0	45.00	6	12.00
B48112.01	12.01	151.0	44.0	45.00	6	12.00
B48112.02	12.02	151.0	44.0	45.00	6	12.00
B48112.03	12.03	151.0	44.0	45.00	6	12.00
B48112.04	12.04	151.0	44.0	45.00	6	12.00
B48112.05	12.05	151.0	44.0	45.00	6	12.00



B441



Carbide Tipped Straight Shank Machine Reamer, H7 Accuracy, Bright Finish

The brazed carbide tip will give extended tool life and a superior performance, when reaming holes within the limits of H7 hole tolerance. The extremely unequal design of the flutes reduces vibration and improves hole roundness, surface finish and size. The tool offers great performance in CNC machines.

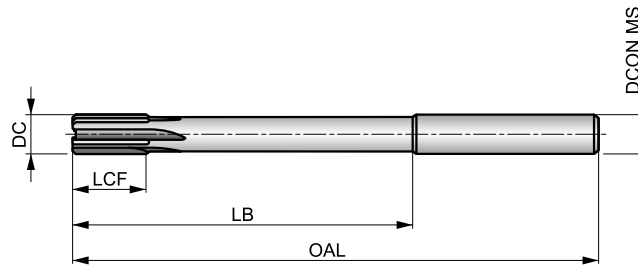

HM	Bright	DIN 8050
R		A
H7		

Workpiece material group suitability, starting values for cutting speed (m/min) and feed Alpha Code. Tables with feed per revolution can be found starting from page 251.

P1.1 ■ 23 B	P1.2 ■ 26 B	P1.3 ■ 27 B	P2.1 ■ 20 B	P2.2 ■ 18 B	P2.3 ■ 16 C	P3.1 ■ 16 B	P3.2 ■ 13 B	P3.3 ■ 11 C	P4.1 ■ 10 B	P4.2 ■ 8 C	P4.3 ■ 7 C	M1.1 ▣ 10 C	M1.2 ▣ 8 C
M2.1 ▣ 9 C	M2.2 ▣ 7 C	M2.3 ▣ 6 B	K1.1 ■ 20 D	K1.2 ■ 15 D	K1.3 ■ 11 D	K2.1 ■ 21 D	K2.2 ■ 17 D	K2.3 ■ 14 D	K3.1 ■ 18 D	K3.2 ■ 14 D	K3.3 ■ 11 D	K5.1 ■ 19 D	K5.2 ■ 15 D
K5.3 ■ 11 D	N1.1 ▣ 60 D	N1.2 ■ 45 D	N1.3 ■ 30 D	N2.1 ■ 38 D	N2.2 ■ 35 D	N2.3 ■ 25 D	N3.1 ■ 64 E	N3.2 ■ 38 E	N3.3 ▣ 19 E	N4.1 ▣ 35 C	N4.2 ▣ 30 C		

DCON MS tolerance h9; Carbide Tipped.

Product	DC [mm]	OAL [mm]	LCF [mm]	LB [mm]	NOF	DCON MS [mm]
B44110.0	10.00	133.0	19.0	87.00	6	10.00
B44111.0	11.00	142.0	19.0	96.00	6	10.00
B44112.0	12.00	151.0	19.0	105.00	6	10.00
B44113.0	13.00	151.0	19.0	105.00	6	10.00
B44114.0	14.00	160.0	19.0	110.00	6	12.50
B44115.0	15.00	162.0	19.0	112.00	6	12.50
B44116.0	16.00	170.0	22.0	120.00	6	12.50
B44117.0	17.00	175.0	22.0	123.00	6	14.00
B44118.0	18.00	182.0	22.0	130.00	6	14.00
B44119.0	19.00	189.0	22.0	131.00	6	16.00
B44120.0	20.00	195.0	22.0	137.00	6	16.00



B411



Carbide Tipped Taper Shank Machine Reamer with H7 Accuracy, Bright Finish

The brazed carbide tips gives significant improvements in performance and a longer tool life when you are reaming hard and abrasive materials. The spiral flutes have unequal spacing between them which effectively reduces vibration and improves hole symmetry, size and finish.

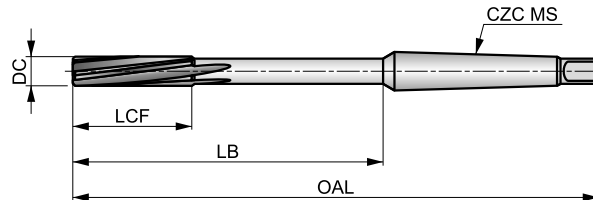

HM	Bright	DIN 8094
R		B
H7		

Workpiece material group suitability, starting values for cutting speed (m/min) and feed Alpha Code. Tables with feed per revolution can be found starting from page 251.

P1.1 ■ 23 B	P1.2 ■ 26 B	P1.3 ■ 27 B	P2.1 ■ 20 B	P2.2 ■ 18 B	P2.3 ■ 16 C	P3.1 ■ 16 B	P3.2 ■ 13 B	P3.3 ■ 11 C	P4.1 ■ 10 B	P4.2 ■ 8 C	P4.3 ■ 7 C	M1.1 ▣ 10 C	M1.2 ▣ 8 C
M2.1 ▣ 9 C	M2.2 ▣ 7 C	M2.3 ▣ 6 B	K1.1 ■ 20 D	K1.2 ■ 15 D	K1.3 ■ 11 D	K2.1 ■ 21 D	K2.2 ■ 17 D	K2.3 ■ 14 D	K3.1 ■ 18 D	K3.2 ■ 14 D	K3.3 ■ 11 D	K5.1 ■ 19 D	K5.2 ■ 15 D
K5.3 ■ 11 D	N1.1 ▣ 60 D	N1.2 ■ 45 D	N1.3 ■ 30 D	N2.1 ■ 38 D	N2.2 ■ 35 D	N2.3 ■ 25 D	N3.1 ■ 64 E	N3.2 ■ 38 E	N3.3 ▣ 19 E	N4.1 ▣ 35 C	N4.2 ▣ 30 C		

DC <= 16mm Carbide head; DC > 16mm Carbide Tipped.

Product	DC [mm]	OAL [mm]	LCF [mm]	LB [mm]	NOF	CZC MS
B4115.0	5.00	133.0	23.0	67.50	6	MK 1
B4116.0	6.00	138.0	26.0	72.50	6	MK 1
B4117.0	7.00	150.0	31.0	84.50	6	MK 1
B4118.0	8.00	156.0	33.0	90.50	6	MK 1
B4119.0	9.00	162.0	36.0	96.50	6	MK 1
B41110.0	10.00	168.0	38.0	102.50	6	MK 1
B41112.0	12.00	182.0	44.0	116.50	6	MK 1
B41114.0	14.00	189.0	47.0	123.50	8	MK 1
B41115.0	15.00	204.0	50.0	124.00	8	MK 2
B41116.0	16.00	210.0	52.0	130.00	8	MK 2
B41117.0	17.00	214.0	54.0	134.00	6	MK 2
B41118.0	18.00	219.0	56.0	139.00	6	MK 2
B41119.0	19.00	223.0	58.0	143.00	6	MK 2
B41120.0	20.00	228.0	60.0	148.00	6	MK 2
B41122.0	22.00	237.0	64.0	157.00	6	MK 2
B41124.0	24.00	268.0	68.0	169.00	8	MK 3
B41125.0	25.00	268.0	68.0	169.00	8	MK 3
B41126.0	26.00	273.0	70.0	174.00	8	MK 3
B41130.0	30.00	281.0	73.0	182.00	8	MK 3



B442



Carbide Tipped Taper Shank Machine Reamer with H7 Accuracy, Bright Finish

Designed with extremely unequal flutes to reduce vibration and improve hole size, roundness and surface finish. The 45° bevel lead ensures accurate location and centering to give you improved hole quality and performance. The brazed carbide tip provides extended tool life and a superior performance.

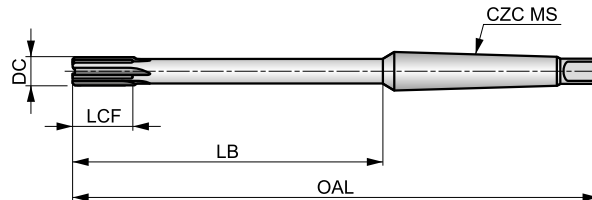

HM	Bright	DIN 8051
R		A
H7		

Workpiece material group suitability, starting values for cutting speed (m/min) and feed Alpha Code. Tables with feed per revolution can be found starting from page 251.

P1.1 ■ 23 B	P1.2 ■ 26 B	P1.3 ■ 27 B	P2.1 ■ 20 B	P2.2 ■ 18 B	P2.3 ■ 16 C	P3.1 ■ 16 B	P3.2 ■ 13 B	P3.3 ■ 11 C	P4.1 ■ 10 B	P4.2 ■ 8 C	P4.3 ■ 7 C	M1.1 ▣ 10 C	M1.2 ▣ 8 C
M2.1 ▣ 9 C	M2.2 ▣ 7 C	M2.3 ▣ 6 B	K1.1 ■ 20 D	K1.2 ■ 15 D	K1.3 ■ 11 D	K2.1 ■ 21 D	K2.2 ■ 17 D	K2.3 ■ 14 D	K3.1 ■ 18 D	K3.2 ■ 14 D	K3.3 ■ 11 D	K5.1 ■ 19 D	K5.2 ■ 15 D
K5.3 ■ 11 D	N1.1 ▣ 60 D	N1.2 ■ 45 D	N1.3 ■ 30 D	N2.1 ■ 38 D	N2.2 ■ 35 D	N2.3 ■ 25 D	N3.1 ■ 64 E	N3.2 ■ 38 E	N3.3 ▣ 19 E	N4.1 ▣ 35 C	N4.2 ▣ 30 C		

Product	DC [mm]	OAL [mm]	LCF [mm]	LB [mm]	NOF	CZC MS
B44210.0	10.00	168.0	19.0	102.50	6	MK 1
B44212.0	12.00	182.0	19.0	116.50	6	MK 1
B44214.0	14.00	189.0	19.0	123.50	6	MK 1
B44215.0	15.00	204.0	19.0	124.00	6	MK 2
B44216.0	16.00	210.0	22.0	130.00	6	MK 2
B44217.0	17.00	214.0	22.0	134.00	6	MK 2
B44218.0	18.00	219.0	22.0	139.00	6	MK 2
B44219.0	19.00	223.0	22.0	143.00	6	MK 2
B44220.0	20.00	228.0	22.0	148.00	6	MK 2



B100



HSS Straight Shank Hand Reamer with H7 Accuracy, Bright and ST Finish

Primarily designed for reaming by hand. It has a precision ground, left-hand helix with right-hand (clockwise) cutting for smooth reaming, creating a more accurate hole size and good surface finish. Suitable for reaming many materials, including steels.

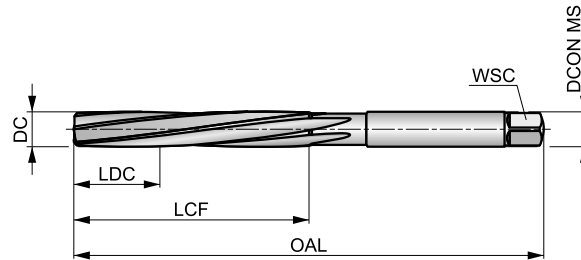

HSS	Bright ST	DIN 206
R		B
H7		

Workpiece material group suitability, starting values for cutting speed (m/min) and feed Alpha Code. Tables with feed per revolution can be found starting from page 251.

P1.1	P1.2	P1.3	P2.1	P2.2	P2.3	P3.1	P3.2	P3.3	P4.1	P4.2	P4.3	M1.1	M1.2
■	■	■	■	■	■	■	■	■	■	■	■	■	■
M2.1	K1.1	K1.2	K1.3	K2.1	K2.2	K2.3	K3.1	K3.2	N1.1	N1.2	N1.3	N2.1	N2.2
■	■	■	■	■	■	■	■	■	■	■	■	■	■
N2.3	N3.1	N3.2	N3.3	N4.1	N4.2								
■	■	■	■	■	■								

DCON MS tolerance e9.

Product	DC [inch]	DC [mm]	OAL [mm]	LCF [mm]	LDC [mm]	NOF	WSC [mm]	DCON MS [mm]
B1001.5	–	1.50	41.0	20.0	5.00	3	1.12	1.50
B1001/16	1/16	1.59	41.0	20.0	5.00	3	1.12	1.59
B1001.6	–	1.60	44.0	21.0	5.00	3	1.25	1.60
B1005/64	5/64	1.98	47.0	23.0	6.00	4	1.40	1.98
B1002.0	–	2.00	50.0	25.0	6.00	4	1.60	2.00
B1003/32	3/32	2.38	54.0	27.0	7.00	4	1.80	2.38
B1002.5	–	2.50	58.0	29.0	7.00	4	2.10	2.50
B1007/64	7/64	2.78	62.0	31.0	8.00	6	2.10	2.78
B1003.0	–	3.00	62.0	31.0	8.00	6	2.40	3.00
B1001/8	1/8	3.18	66.0	33.0	8.00	6	2.40	3.18
B1003.2	–	3.20	66.0	33.0	8.00	6	2.40	3.20
B1003.5	–	3.50	71.0	35.0	9.00	6	2.70	3.50
B1009/64	9/64	3.57	71.0	35.0	9.00	6	2.70	3.57
B1005/32	5/32	3.97	76.0	38.0	10.00	6	3.00	3.97
B1004.0	–	4.00	76.0	38.0	10.00	6	3.00	4.00
B10011/64	11/64	4.37	81.0	41.0	10.00	6	3.40	4.37
B1004.5	–	4.50	81.0	41.0	10.00	6	3.40	4.50
B1003/16	3/16	4.76	87.0	44.0	11.00	6	3.80	4.76
B1005.0	–	5.00	87.0	44.0	11.00	6	3.80	5.00
B10013/64	13/64	5.16	87.0	44.0	11.00	6	3.80	5.16
B1005.5	–	5.50	93.0	47.0	12.00	6	4.30	5.50
B1007/32	7/32	5.56	93.0	47.0	12.00	6	4.30	5.56
B10015/64	15/64	5.95	93.0	47.0	12.00	6	4.90	5.95
B1006.0	–	6.00	93.0	47.0	12.00	6	4.90	6.00
B1001/4	1/4	6.35	100.0	50.0	13.00	6	4.90	6.35
B1006.5	–	6.50	100.0	50.0	13.00	6	4.90	6.50
B10017/64	17/64	6.75	107.0	54.0	14.00	6	5.50	6.75



Product	DC	DC	OAL	LCF	LDC	NOF	WSC	DCON MS
	[inch]	[mm]	[mm]	[mm]	[mm]		[mm]	[mm]
B1007.0	–	7.00	107.0	54.0	14.00	6	5.50	7.00
B1009/32	9/32	7.14	107.0	54.0	14.00	6	6.20	7.14
B1007.5	–	7.50	107.0	54.0	14.00	6	6.20	7.50
B10019/64	19/64	7.54	115.0	58.0	15.00	6	6.20	7.54
B1005/16	5/16	7.94	115.0	58.0	15.00	6	6.20	7.94
B1008.0	–	8.00	115.0	58.0	15.00	6	6.20	8.00
B10021/64	21/64	8.33	115.0	58.0	15.00	6	7.00	8.33
B1008.5	–	8.50	115.0	58.0	15.00	6	7.00	8.50
B10011/32	11/32	8.73	124.0	62.0	16.00	6	7.00	8.73
B1009.0	–	9.00	124.0	62.0	16.00	6	7.00	9.00
B10023/64	23/64	9.13	124.0	62.0	16.00	6	8.00	9.13
B1009.5	–	9.50	124.0	62.0	16.00	6	8.00	9.50
B1003/8	3/8	9.52	124.0	62.0	17.00	6	8.00	9.52
B10025/64	25/64	9.92	133.0	66.0	17.00	6	8.00	9.92
B10010.0	–	10.00	133.0	66.0	17.00	6	8.00	10.00
B10013/32	13/32	10.32	133.0	66.0	17.00	6	8.00	10.32
B10010.5	–	10.50	133.0	66.0	17.00	6	8.00	10.50
B10011.0	–	11.00	142.0	71.0	18.00	6	9.00	11.00
B1007/16	7/16	11.11	142.0	71.0	18.00	6	9.00	11.11
B10011.5	–	11.50	142.0	71.0	18.00	6	9.00	11.50
B10012.0	–	12.00	152.0	76.0	19.00	6	9.00	12.00
B10012.5	–	12.50	152.0	76.0	19.00	6	10.00	12.50
B1001/2	1/2	12.70	152.0	76.0	19.00	6	10.00	12.70
B10013.0	–	13.00	152.0	76.0	19.00	6	10.00	13.00
B10017/32	17/32	13.49	163.0	81.0	20.00	8	11.00	13.49
B10013.5	–	13.50	163.0	81.0	20.00	8	11.00	13.50
B10014.0	–	14.00	163.0	81.0	20.00	8	11.00	14.00
B1009/16	9/16	14.29	163.0	81.0	20.00	8	11.00	14.29
B10014.5	–	14.50	163.0	81.0	20.00	8	11.00	14.50
B10015.0	–	15.00	163.0	81.0	20.00	8	12.00	15.00
B10019/32	19/32	15.08	163.0	81.0	22.00	8	12.00	15.08
B1005/8	5/8	15.88	175.0	87.0	22.00	8	12.00	15.88
B10016.0	–	16.00	175.0	87.0	22.00	8	12.00	16.00
B10017.0	–	17.00	175.0	87.0	22.00	8	13.00	17.00
B10011/16	11/16	17.46	188.0	93.0	23.00	8	14.50	17.46
B10018.0	–	18.00	188.0	93.0	23.00	8	14.50	18.00
B10019.0	–	19.00	188.0	93.0	23.00	8	14.50	19.00
B1003/4	3/4	19.05	188.0	93.0	25.00	8	14.50	19.05
B10020.0	–	20.00	201.0	100.0	25.00	8	16.00	20.00
B10013/16	13/16	20.64	201.0	100.0	25.00	8	16.00	20.64
B10021.0	–	21.00	201.0	100.0	25.00	8	16.00	21.00
B10022.0	–	22.00	215.0	107.0	27.00	8	18.00	22.00
B1007/8	7/8	22.22	215.0	107.0	27.00	8	18.00	22.22
B10023.0	–	23.00	215.0	107.0	27.00	8	18.00	23.00
B10024.0	–	24.00	231.0	115.0	29.00	8	18.00	24.00
B10025.0	–	25.00	231.0	115.0	29.00	8	20.00	25.00
B1001	1"	25.40	231.0	115.0	29.00	8	20.00	25.40
B10026.0	–	26.00	231.0	115.0	29.00	8	20.00	26.00
B10027.0	–	27.00	247.0	124.0	31.00	10	22.00	27.00
B10028.0	–	28.00	247.0	124.0	31.00	10	22.00	28.00
B10029.0	–	29.00	247.0	124.0	31.00	10	22.00	29.00
B10030.0	–	30.00	247.0	124.0	31.00	10	24.00	30.00
B10031.0	–	31.00	265.0	133.0	33.00	10	24.00	31.00
B10032.0	–	32.00	265.0	133.0	33.00	10	24.00	32.00
B10033.0	–	33.00	265.0	133.0	33.00	10	26.00	33.00
B10034.0	–	34.00	284.0	142.0	36.00	10	26.00	34.00
B10035.0	–	35.00	284.0	142.0	36.00	10	29.00	35.00
B10036.0	–	36.00	284.0	142.0	36.00	10	29.00	36.00
B10037.0	–	37.00	284.0	142.0	36.00	10	29.00	37.00
B10038.0	–	38.00	305.0	152.0	38.00	10	29.00	38.00
B10039.0	–	39.00	305.0	152.0	38.00	10	32.00	39.00
B10040.0	–	40.00	305.0	152.0	38.00	10	32.00	40.00
B10045.0	–	45.00	326.0	163.0	41.00	12	35.00	45.00
B10050.0	–	50.00	347.0	174.0	44.00	12	39.00	50.00



B334



HSS Straight Shank Adjustable Hand Reamer

This hand reamer is easily adjustable, helping to finish many different diameter holes with a single reamer. With precision ground blades and straight flute geometry, smooth reaming and improved hole size and surface finish are achieved. Suitable for reaming in many materials.

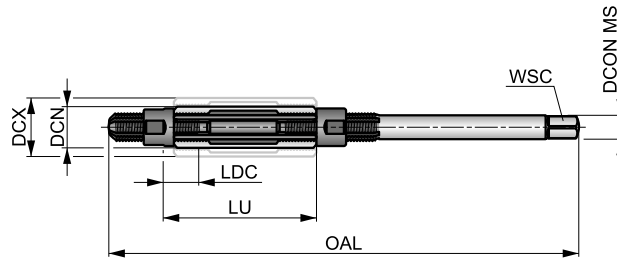

Workpiece material group suitability, starting values for cutting speed (m/min) and feed Alpha Code. Tables with feed per revolution can be found starting from page 251.

P1.1	P1.2	P1.3	P2.1	P2.2	P2.3	P3.1	P3.2	P3.3	P4.1	P4.2	P4.3	M1.1	M1.2
■	■	■	■	■	■	■	■	■	■	■	■	■	■
M2.1	K1.1	K1.2	K1.3	K2.1	K2.2	K2.3	K3.1	K3.2	N1.1	N1.2	N1.3	N2.1	N2.2
■	■	■	■	■	■	■	■	■	■	■	■	■	■
N2.3	N3.1	N3.2	N3.3	N4.1	N4.2								
■	■	■	■	■	■								

Product	Nr.	DCN	DCX	OAL	LU	LDC	NOF	WSC
		[mm]	[mm]	[mm]	[mm]	[mm]		[mm]
B334000	000	6.40	7.20	110.0	32.00	7.00	4	3.00
B33400	00	7.20	8.00	110.0	32.00	7.00	4	3.40
B3340	0	8.00	9.00	115.0	34.00	9.00	5	3.80
B3341	1	9.00	10.00	115.0	34.00	9.00	5	4.30
B3342	2	10.00	11.00	115.0	34.00	9.00	5	4.90
B3343	3	11.00	12.00	125.0	35.00	9.00	5	4.90
B3344	4	12.00	13.50	135.0	41.00	9.00	5	6.20
B3345	5	13.50	15.50	146.0	50.00	12.00	5	7.00
B3346	6	15.50	18.00	166.0	60.00	12.00	5	8.00
B3347	7	18.00	21.00	178.0	65.00	15.00	5	9.00
B3348	8	21.00	24.00	195.0	76.00	15.00	5	11.00
B3349	9	24.00	27.50	218.0	82.00	18.00	5	12.00
B33410	10	27.50	31.50	245.0	86.00	18.00	5	14.50
B33411	11	31.50	37.00	280.0	98.00	18.00	6	18.00
B33412	12	37.00	45.00	325.0	108.00	20.00	6	20.00
B33413	13	45.00	55.00	370.0	118.00	20.00	6	26.00
B33414	14	55.00	67.00	400.0	125.00	20.00	6	32.00
B33415	15	67.00	80.00	435.0	140.00	23.00	8	39.00
B33416	16	80.00	95.00	475.0	155.00	23.00	8	49.00



B335



Replacement Blades and Nuts for Use in the Adjustable Hand Reamer, B334

The nut and blades can be purchased separately and are each available in 19 sizes.

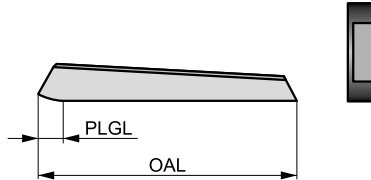

Product	Nr.	PLGL	OAL
		[mm]	[mm]
B335000BLADES	000	7.00	32.0
B335000NUT	000	–	–
B33500BLADES	00	7.00	32.0
B33500NUT	00	–	–
B3350BLADES	0	9.00	34.0
B3350NUT	0	–	–
B3351BLADES	1	9.00	34.0
B3351NUT	1	–	–
B3352BLADES	2	9.00	34.0
B3352NUT	2	–	–
B3353BLADES	3	9.00	35.0
B3353NUT	3	–	–
B3354BLADES	4	9.00	41.0
B3354NUT	4	–	–
B3355BLADES	5	12.00	50.0
B3355NUT	5	–	–
B3356BLADES	6	12.00	60.0
B3356NUT	6	–	–
B3357BLADES	7	15.00	65.0

Product	Nr.	PLGL	OAL
		[mm]	[mm]
B3357NUT	7	–	–
B3358BLADES	8	15.00	76.0
B3358NUT	8	–	–
B3359BLADES	9	18.00	82.0
B3359NUT	9	–	–
B33510BLADES	10	18.00	86.0
B33510NUT	10	–	–
B33511BLADES	11	18.00	98.0
B33511NUT	11	–	–
B33512BLADES	12	20.00	108.0
B33512NUT	12	–	–
B33513BLADES	13	20.00	118.0
B33513NUT	13	–	–
B33514BLADES	14	20.00	125.0
B33514NUT	14	–	–
B33515BLADES	15	23.00	140.0
B33515NUT	15	–	–
B33516BLADES	16	23.00	155.0
B33516NUT	16	–	–



B901



HSS-E Straight Shank Machine Reamer, H7 Accuracy, Bright and ST Finish

The precision ground geometry, with left-hand helix and right-hand cutting, improves hole size and surface finish. The reamer has a straight shank for high performance machine reaming. Suitable for reaming in many materials.

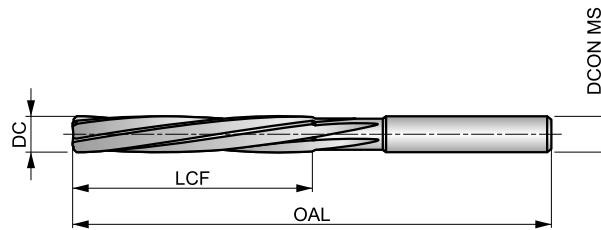

HSS-E	Bright ST	BS 328
R		B
H7		

Workpiece material group suitability, starting values for cutting speed (m/min) and feed Alpha Code. Tables with feed per revolution can be found starting from page 251.

P1.1 ■ 15 C	P1.2 ■ 16 C	P1.3 ■ 17 C	P2.1 ■ 13 C	P2.2 ■ 11 C	P2.3 ▧ 10 B	P3.1 ■ 7 B	P3.2 ■ 6 B	P3.3 ▧ 5 B	P4.1 ■ 4 B	P4.2 ▧ 4 B	P4.3 ▧ 3 A	M1.1 ▧ 10 C	M1.2 ▧ 8 C
M2.1 ▧ 9 C	K1.1 ■ 14 E	K1.2 ■ 10 D	K1.3 ▧ 8 D	K2.1 ■ 12 C	K2.2 ■ 10 C	K2.3 ▧ 8 C	K3.1 ▧ 11 C	K3.2 ▧ 8 C	N1.1 ▧ 23 F	N1.2 ■ 17 F	N1.3 ■ 12 F	N2.1 ■ 25 E	N2.2 ■ 22 E
N2.3 ▧ 14 E	N3.1 ■ 34 D	N3.2 ■ 20 E	N3.3 ■ 10 D	N4.1 ▧ 22 B	N4.2 ▧ 21 B								

Product	DC	DC	OAL	LCF	NOF	DCON MS
	[inch]	[mm]	[mm]	[mm]		[mm]
B9011.5	—	1.50	44.0	21.0	4	1.50
B9011/16	1/16	1.59	44.0	21.0	4	1.59
B9012.0	—	2.00	50.0	25.0	4	2.00
B9013/32	3/32	2.38	58.0	29.0	4	2.38
B9012.5	—	2.50	58.0	29.0	4	2.50
B9013.0	—	3.00	62.0	31.0	4	3.00
B9011/8	1/8	3.18	66.0	33.0	4	3.18
B9013.5	—	3.50	71.0	35.0	4	3.50
B9015/32	5/32	3.97	76.0	38.0	6	3.97
B9014.0	—	4.00	76.0	38.0	6	4.00
B9014.5	—	4.50	81.0	41.0	6	4.50
B9013/16	3/16	4.76	87.0	44.0	6	4.76
B9015.0	—	5.00	87.0	44.0	6	5.00
B90113/64	13/64	5.16	87.0	44.0	6	5.16
B9015.5	—	5.50	93.0	47.0	6	5.50

Product	DC	DC	OAL	LCF	NOF	DCON MS
	[inch]	[mm]	[mm]	[mm]		[mm]
B9017/32	7/32	5.56	93.0	47.0	6	5.56
B90115/64	15/64	5.95	93.0	47.0	6	5.95
B9016.0	—	6.00	93.0	47.0	6	6.00
B9011/4	1/4	6.35	100.0	50.0	6	6.35
B9017.0	—	7.00	107.0	54.0	6	7.00
B9019/32	9/32	7.14	107.0	54.0	6	7.14
B9015/16	5/16	7.94	115.0	58.0	6	7.94
B9018.0	—	8.00	115.0	58.0	6	8.00
B9019.0	—	9.00	124.0	62.0	6	9.00
B9013/8	3/8	9.52	133.0	66.0	6	9.52
B90110.0	—	10.00	133.0	66.0	6	10.00
B90111.0	—	11.00	142.0	71.0	6	11.00
B9017/16	7/16	11.11	142.0	71.0	6	11.11
B90112.0	—	12.00	152.0	76.0	6	12.00
B9011/2	1/2	12.70	152.0	76.0	6	12.70



B301



HSS Straight Shank Taper Pin Hand Reamer 1:48 Taper, Bright and ST Finish

Designed to finish tapered holes to accept standard 1 to 48 ratio imperial taper pins. With a reduced small diameter, the tool easily locates and centers in the pre-drilled hole to improve accuracy and performance. Suitable for reaming in many materials.

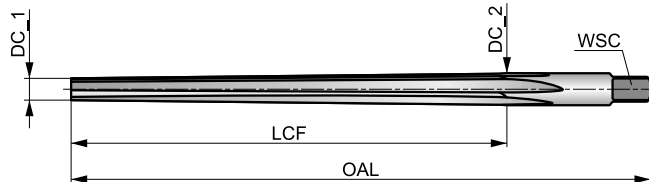

HSS	Bright ST	BS 328
R		A
1:48		

Workpiece material group suitability, starting values for cutting speed (m/min) and feed Alpha Code. Tables with feed per revolution can be found starting from page 251.

P1.1	P1.2	P1.3	P2.1	P2.2	P2.3	P3.1	P3.2	P3.3	P4.1	P4.2	P4.3	M1.1	M1.2
■	■	■	■	■	■	■	■	■	■	■	■	■	■
M2.1	K1.1	K1.2	K1.3	K2.1	K2.2	K2.3	K3.1	K3.2	N1.1	N1.2	N1.3	N2.1	N2.2
■	■	■	■	■	■	■	■	■	■	■	■	■	■
N2.3	N3.1	N3.2	N3.3	N4.1	N4.2								
■	■	■	■	■	■								

DC <= 1/4 limit of tolerance +0.0030; DC >= 9/32 limit of tolerance +0.0050.

Product	nom d	DC_1	DC_2	OAL	LCF	NOF	WSC	DCON MS
		[mm]	[mm]					
B3011/16	1/16	1.10	1.63	51.0	25.0	4	1.20	1.63
B3015/64	5/64	1.50	2.03	51.0	25.0	4	1.60	2.03
B3013/32	3/32	1.75	2.41	57.0	32.0	4	2.00	2.41
B3017/64	7/64	2.03	2.82	64.0	38.0	4	2.20	2.82
B3011/8	1/8	2.30	3.23	70.0	44.0	4	2.50	3.23
B3019/64	9/64	2.64	3.63	73.0	48.0	4	2.80	3.63
B3015/32	5/32	2.95	4.01	76.0	51.0	4	3.10	4.01
B30111/64	11/64	3.23	4.42	89.0	57.0	4	3.60	4.42
B3013/16	3/16	3.50	4.95	102.0	70.0	4	4.00	4.95
B3017/32	7/32	4.13	5.59	102.0	70.0	6	4.50	5.59
B3011/4	1/4	4.64	6.43	117.0	86.0	6	5.00	6.43
B3019/32	9/32	5.23	7.42	143.0	105.0	6	5.60	7.42
B3015/16	5/16	5.84	8.03	143.0	105.0	6	6.30	8.03
B30111/32	11/32	6.43	8.81	152.0	114.0	6	7.10	8.81
B3013/8	3/8	7.03	9.68	165.0	127.0	6	8.00	9.68
B30113/32	13/32	7.42	10.46	191.0	146.0	6	8.00	10.46
B3017/16	7/16	8.21	11.25	191.0	146.0	6	9.00	11.25
B3011/2	1/2	9.41	12.85	210.0	165.0	6	10.00	12.85



B903



HSS Straight Shank Taper Pin Hand Reamer 1:50 Taper, Bright and ST Finish

Designed to finish tapered holes to accept standard 1 to 50 ratio metric taper pins. The diameter of the small end is reduced to make it easier to locate and center the reamer in the hole. Suitable for reaming in many materials.

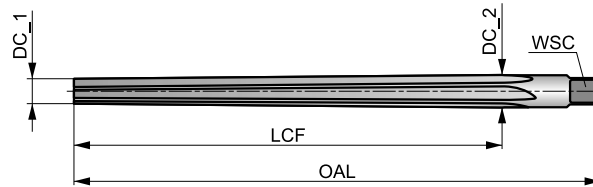

HSS	Bright ST	DIN 9
R		A
1:50		

Workpiece material group suitability, starting values for cutting speed (m/min) and feed Alpha Code. Tables with feed per revolution can be found starting from page 251.

P1.1	P1.2	P1.3	P2.1	P2.2	P2.3	P3.1	P3.2	P3.3	P4.1	P4.2	P4.3	M1.1	M1.2
■	■	■	■	■	■	■	■	■	■	■	■	■	■
M2.1	K1.1	K1.2	K1.3	K2.1	K2.2	K2.3	K3.1	K3.2	N1.1	N1.2	N1.3	N2.1	N2.2
■	■	■	■	■	■	■	■	■	■	■	■	■	■
N2.3	N3.1	N3.2	N3.3	N4.1	N4.2								
■	■	■	■	■	■								

DCON MS tolerance h11; DC ≤ 5mm limit of tolerance +0.0750; DC < 5mm limit of tolerance +0.1250.

Product	nom d	DC_1	DC_2	OAL	LCF	NOF	WSC	DCON MS
		[mm]	[mm]	[mm]	[mm]		[mm]	[mm]
B9031.5	1.5	1.40	2.14	57.0	37.0	4	1.80	2.14
B9032.0	2.0	1.90	2.86	68.0	48.0	4	2.24	2.86
B9032.5	2.5	2.40	3.36	68.0	48.0	4	2.80	3.36
B9033.0	3.0	2.90	4.06	80.0	58.0	4	3.15	4.00
B9034.0	4.0	3.90	5.26	93.0	68.0	4	4.00	5.00
B9035.0	5.0	4.90	6.36	100.0	73.0	4	5.00	6.30
B9036.0	6.0	5.90	8.00	135.0	105.0	6	6.30	7.90
B9038.0	8.0	7.90	10.80	180.0	145.0	6	8.00	10.50
B90310.0	10.0	9.90	13.40	215.0	175.0	6	10.00	13.30
B90312.0	12.0	11.80	16.00	255.0	210.0	8	11.20	16.00
B90313.0	13.0	12.86	16.74	255.0	210.0	8	12.50	16.74
B90314.0	14.0	13.86	17.74	255.0	210.0	8	12.50	17.74
B90316.0	16.0	15.80	20.40	280.0	230.0	8	14.00	20.40
B90320.0	20.0	19.80	24.80	310.0	250.0	8	18.00	24.80



B952



HSS Straight Shank Taper Pin Hand Reamer 1:50 Taper, Bright Finish

With left-hand helix and right-hand cutting, gives smooth reaming for a more accurate hole size and better finish. The small end diameter has been reduced, making it easier to locate and center the reamer in the hole. Suitable for reaming in many materials.

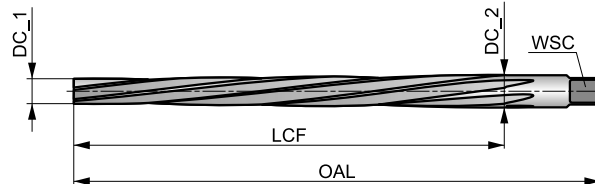

HSS	Bright	DIN 9
R		B
1:50		

Workpiece material group suitability, starting values for cutting speed (m/min) and feed Alpha Code. Tables with feed per revolution can be found starting from page 251.

P1.1	P1.2	P1.3	P2.1	P2.2	P2.3	P3.1	P3.2	P3.3	P4.1	P4.2	P4.3	M1.1	M1.2
■	■	■	■	■	■	■	■	■	■	■	■	■	■
M2.1	K1.1	K1.2	K1.3	K2.1	K2.2	K2.3	K3.1	K3.2	N1.1	N1.2	N1.3	N2.1	N2.2
■	■	■	■	■	■	■	■	■	■	■	■	■	■
N2.3	N3.1	N3.2	N3.3	N4.1	N4.2								
■	■	■	■	■	■								

DCON MS tolerance h11; DC <= 2.5mm Straight flute, form A.

Product	nom d	DC_1	DC_2	OAL	LCF	NOF	WSC	DCON MS
		[mm]	[mm]					
B9521.2	1.2	1.10	1.74	50.0	32.0	3	2.40	3.15
B9521.5	1.5	1.40	2.14	57.0	37.0	3	2.40	3.15
B9522.0	2.0	1.90	2.86	68.0	48.0	3	2.40	3.15
B9522.5	2.5	2.40	3.36	68.0	48.0	4	2.40	3.15
B9523.0	3.0	2.90	4.06	80.0	58.0	5	3.00	4.00
B9523.5	3.5	3.40	4.66	87.0	63.0	5	3.40	4.50
B9524.0	4.0	3.90	5.26	93.0	68.0	5	3.80	5.00
B9524.5	4.5	4.40	5.80	95.0	70.0	5	4.30	5.60
B9525.0	5.0	4.90	6.36	100.0	73.0	5	4.90	6.30
B9525.5	5.5	5.40	7.20	118.0	90.0	6	5.50	7.10
B9526.0	6.0	5.90	8.00	135.0	105.0	6	6.20	8.00
B9526.5	6.5	6.40	8.60	140.0	110.0	6	6.20	8.00
B9527.0	7.0	6.90	9.40	160.0	125.0	6	7.00	9.00
B9528.0	8.0	7.90	10.80	180.0	145.0	6	8.00	10.00
B9529.0	9.0	8.90	12.10	195.0	160.0	6	9.00	11.20
B95210.0	10.0	9.90	13.40	215.0	175.0	6	10.00	12.50
B95212.0	12.0	11.80	16.00	255.0	210.0	8	11.00	14.00
B95213.0	13.0	12.80	17.00	255.0	210.0	8	12.00	16.00
B95214.0	14.0	13.80	18.00	255.0	210.0	8	12.00	16.00
B95216.0	16.0	15.80	20.40	280.0	230.0	8	14.50	18.00
B95220.0	20.0	19.80	24.80	310.0	250.0	8	18.00	22.40
B95225.0	25.0	24.70	30.70	370.0	300.0	10	22.00	28.00
B95230.0	30.0	29.70	36.10	400.0	320.0	10	24.00	31.50
B95240.0	40.0	39.70	46.50	430.0	340.0	12	32.00	40.00
B95250.0	50.0	49.70	56.90	460.0	360.0	12	39.00	50.00



B122



HSS Reduced Shank Hand Car Reamer, Steam and Bronze Tempered Finish

Designed to re-align holes in thin walled sheets of steel, prior to bolting or riveting them together. It is designed to be used by hand. The small Pilot diameter makes it easy to locate and align the tool into pre-drilled holes. Suitable in many materials.

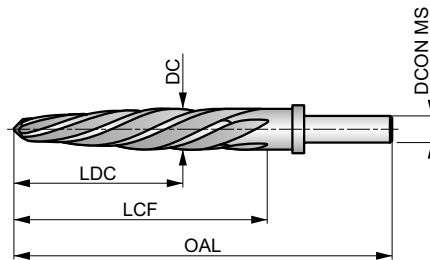

HSS	ST Bronze	ANSI
R		

Workpiece material group suitability, starting values for cutting speed (m/min) and feed Alpha Code. Tables with feed per revolution can be found starting from page 251.

P1.1 ■ 15 C	P1.2 ■ 16 C	P1.3 ■ 17 C	P2.1 ■ 13 C	P2.2 ■ 11 C	P3.1 ■ 7 B	M1.1 ■ 11 C	M1.2 ■ 10 B	M2.1 ■ 9 B	N1.1 ■ 23 F	N1.2 ■ 17 F	N2.1 ■ 23 E	N2.2 ■ 21 E	N3.1 ■ 34 D
N3.2 ■ 20 E	N4.1 ■ 22 B	N4.2 ■ 21 B											

Product	DC [inch]	DC [inch]	OAL [inch]	LCF [inch]	NOF	DCONMS [inch]
B1223/8	3/8	0.3750	4.5/8	2.1/2	4	3/8
B1221/2	1/2	0.5000	5.7/8	3.3/4	5	1/2
B1229/16	9/16	0.5625	5.7/8	3.3/4	5	1/2
B1225/8	5/8	0.6250	6.3/8	4.1/4	5	1/2
B12211/16	11/16	0.6875	6.3/8	4.1/4	5	1/2
B1223/4	3/4	0.7500	6.7/8	4.1/2	5	1/2
B12213/16	13/16	0.8125	6.7/8	4.1/2	5	1/2
B1227/8	7/8	0.8750	6.7/8	4.1/2	5	1/2
B12215/16	15/16	0.9375	6.7/8	4.1/2	5	1/2
B1221	1"	1.0000	6.7/8	4.1/2	5	1/2
B1221.1/16	1.1/16	1.0625	6.7/8	4.1/2	5	1/2



B953



HSS-E Straight Shank Taper Pin Hand Reamer 1:50 Taper, Bright Finish

With a high spiral, left-hand helix and right-hand cutting. The taper on the reamer is designed to finish tapered holes to take standard 1 to 50 ratio metric taper pins, while the taper point has a reduced diameter to improve performance. Suitable for reaming in many materials.

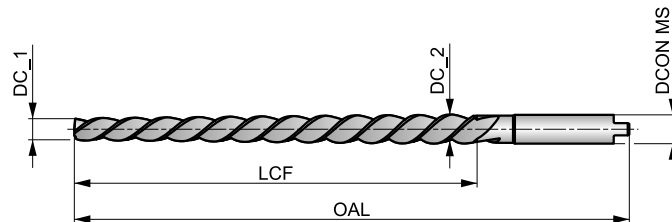

HSS-E	Bright	DIN 2179
R	1:50	

Workpiece material group suitability, starting values for cutting speed (m/min) and feed Alpha Code. Tables with feed per revolution can be found starting from page 251.

P1.1 ■ 10 B	P1.2 ■ 12 B	P1.3 ■ 13 B	P2.1 ■ 9 B	P2.2 ■ 8 B	P2.3 ▣ 6 A	P3.1 ■ 7 A	P3.2 ▣ 6 A	P3.3 ▣ 3 A	P4.1 ■ 4 A	P4.2 ▣ 3 A	P4.3 ▣ 2 A	M1.1 ▣ 11 C	M1.2 ▣ 10 B
M2.1 ▣ 9 B	M2.2 ▣ 8 B	K1.1 ■ 10 C	K1.2 ■ 6 B	K1.3 ▣ 4 B	K2.1 ■ 8 A	K2.2 ■ 6 A	K2.3 ▣ 4 A	K3.1 ■ 7 A	K3.2 ▣ 4 A	N1.1 ▣ 14 D	N1.2 ■ 12 D	N1.3 ■ 9 D	N2.1 ■ 16 C
N2.2 ■ 14 C	N2.3 ▣ 10 C	N3.1 ■ 22 B	N3.2 ■ 14 C	N3.3 ▣ 6 B	N4.1 ▣ 22 B								

DCON MS tolerance h9.

Product	nom d	DC_1	DC_2	OAL	LCF	NOF	DCON MS
		[mm]	[mm]	[mm]	[mm]		[mm]
B9531.0	1.0	0.80	1.46	60.0	33.0	2	1.40
B9531.5	1.5	1.40	2.14	70.0	37.0	2	2.10
B9532.0	2.0	1.90	2.86	86.0	48.0	3	3.15
B9532.5	2.5	2.40	3.36	86.0	48.0	3	3.15
B9533.0	3.0	2.90	4.06	100.0	58.0	3	4.00
B9534.0	4.0	3.90	5.26	112.0	68.0	3	5.00
B9535.0	5.0	4.90	6.36	122.0	73.0	3	6.30
B9536.0	6.0	5.90	8.00	160.0	105.0	3	8.00
B9536.5	6.5	6.40	8.78	188.0	119.0	3	8.50
B9538.0	8.0	7.90	10.80	207.0	145.0	3	10.00
B95310.0	10.0	9.90	13.40	245.0	175.0	3	12.50
B95312.0	12.0	11.80	16.00	290.0	210.0	3	16.00



B180



HSS-E Straight Shank Machine Reamer with H7 Accuracy, Bright Finish

High performance reamer for CNC machines and held in high accuracy tool holders or chucks. The precision ground left-hand helix and right-hand cutting action ensures smooth reaming and improved surface finish and hole size. Suitable for reaming in many materials.

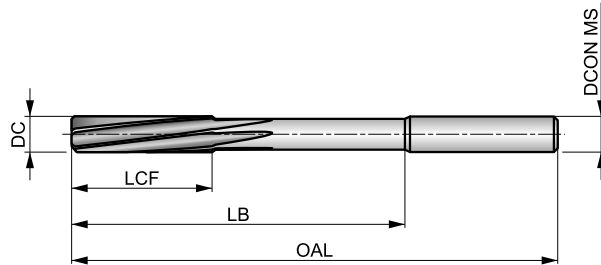

HSS-E	Bright	DIN 212
R	DIN 6535HA	B
H7		

Workpiece material group suitability, starting values for cutting speed (m/min) and feed Alpha Code. Tables with feed per revolution can be found starting from page 251.

P1.1 ■ 21 C	P1.2 ■ 24 C	P1.3 ■ 25 C	P2.1 ■ 18 C	P2.2 ■ 16 C	P2.3 ■ 14 B	P3.1 ■ 13 B	P3.2 ■ 11 B	P3.3 ■ 9 B	P4.1 ■ 8 B	P4.2 ■ 7 B	P4.3 ■ 5 A	M1.1 ■ 11 C	M1.2 ■ 10 B
M2.1 ■ 9 B	K1.1 ■ 16 E	K1.2 ■ 12 D	K1.3 ■ 9 D	K2.1 ■ 16 C	K2.2 ■ 13 C	K2.3 ■ 10 C	K3.1 ■ 14 C	K3.2 ■ 11 C	N1.1 ■ 24 F	N1.2 ■ 18 F	N1.3 ■ 11 F	N2.1 ■ 27 E	N2.2 ■ 24 E
N2.3 ■ 16 E	N3.1 ■ 47 D	N3.2 ■ 28 E	N3.3 ■ 14 D	N4.1 ■ 30 B									

DCON MS tolerance h6.

Product	DC	OAL	LCF	LB	NOF	DCON MS
	[mm]	[mm]	[mm]	[mm]		[mm]
B1801.5	1.50	40.0	8.0	18.00	3	2.00
B1801.6	1.60	43.0	9.0	20.00	3	2.00
B1801.7	1.70	43.0	9.0	20.00	3	2.00
B1801.8	1.80	46.0	10.0	22.00	4	2.00
B1801.9	1.90	46.0	10.0	22.00	4	2.00
B1802.0	2.00	49.0	11.0	24.00	4	2.00
B1802.1	2.10	49.0	11.0	24.00	4	2.00
B1802.2	2.20	53.0	12.0	26.00	4	3.00
B1802.3	2.30	53.0	12.0	26.00	4	3.00
B1802.4	2.40	57.0	14.0	28.00	4	3.00
B1802.5	2.50	57.0	14.0	28.00	4	3.00
B1802.6	2.60	57.0	14.0	28.00	4	3.00
B1802.7	2.70	61.0	15.0	32.00	6	3.00
B1802.8	2.80	61.0	15.0	32.00	6	3.00
B1802.9	2.90	61.0	15.0	32.00	6	3.00
B1803.0	3.00	61.0	15.0	32.00	6	3.00
B1803.1	3.10	65.0	16.0	35.00	6	4.00
B1803.2	3.20	65.0	16.0	35.00	6	4.00
B1803.3	3.30	65.0	16.0	35.00	6	4.00
B1803.4	3.40	70.0	18.0	40.00	6	4.00
B1803.5	3.50	70.0	18.0	40.00	6	4.00
B1803.6	3.60	70.0	18.0	40.00	6	4.00
B1803.7	3.70	70.0	18.0	40.00	6	4.00
B1803.8	3.80	75.0	19.0	43.00	6	4.00
B1803.9	3.90	75.0	19.0	43.00	6	4.00
B1804.0	4.00	75.0	19.0	43.00	6	4.00
B1804.1	4.10	75.0	19.0	43.00	6	4.00

Product	DC	OAL	LCF	LB	NOF	DCON MS
	[mm]	[mm]	[mm]	[mm]		[mm]
B1804.2	4.20	75.0	19.0	43.00	6	4.00
B1804.3	4.30	80.0	21.0	47.00	6	5.00
B1804.4	4.40	80.0	21.0	47.00	6	5.00
B1804.5	4.50	80.0	21.0	47.00	6	5.00
B1804.6	4.60	80.0	21.0	47.00	6	5.00
B1804.7	4.70	80.0	21.0	47.00	6	5.00
B1804.8	4.80	86.0	23.0	52.00	6	5.00
B1804.9	4.90	86.0	23.0	52.00	6	5.00
B1805.0	5.00	86.0	23.0	52.00	6	5.00
B1805.1	5.10	86.0	23.0	52.00	6	5.00
B1805.2	5.20	86.0	23.0	52.00	6	5.00
B1805.3	5.30	86.0	23.0	52.00	6	5.00
B1805.4	5.40	93.0	26.0	57.00	6	6.00
B1805.5	5.50	93.0	26.0	57.00	6	6.00
B1805.6	5.60	93.0	26.0	57.00	6	6.00
B1805.7	5.70	93.0	26.0	57.00	6	6.00
B1805.8	5.80	93.0	26.0	57.00	6	6.00
B1805.9	5.90	93.0	26.0	57.00	6	6.00
B1806.0	6.00	93.0	26.0	57.00	6	6.00
B1806.1	6.10	101.0	28.0	63.00	6	6.00
B1806.2	6.20	101.0	28.0	63.00	6	6.00
B1806.3	6.30	101.0	28.0	63.00	6	6.00
B1806.4	6.40	101.0	28.0	63.00	6	6.00
B1806.5	6.50	101.0	28.0	63.00	6	6.00
B1806.6	6.60	101.0	28.0	63.00	6	6.00
B1806.7	6.70	101.0	28.0	63.00	6	6.00
B1806.8	6.80	109.0	31.0	69.00	6	8.00



Product	DC	OAL	LCF	LB	NOF	DCON MS
	[mm]	[mm]	[mm]	[mm]		[mm]
B1806.9	6.90	109.0	31.0	69.00	6	8.00
B1807.0	7.00	109.0	31.0	69.00	6	8.00
B1807.1	7.10	109.0	31.0	69.00	6	8.00
B1807.2	7.20	109.0	31.0	69.00	6	8.00
B1807.3	7.30	109.0	31.0	69.00	6	8.00
B1807.4	7.40	109.0	31.0	69.00	6	8.00
B1807.5	7.50	109.0	31.0	69.00	6	8.00
B1807.6	7.60	117.0	33.0	75.00	6	8.00
B1807.7	7.70	117.0	33.0	75.00	6	8.00
B1807.8	7.80	117.0	33.0	75.00	6	8.00
B1807.9	7.90	117.0	33.0	75.00	6	8.00
B1808.0	8.00	117.0	33.0	75.00	6	8.00
B1808.1	8.10	117.0	33.0	75.00	6	8.00
B1808.2	8.20	117.0	33.0	75.00	6	8.00
B1808.3	8.30	117.0	33.0	75.00	6	8.00
B1808.4	8.40	117.0	33.0	75.00	6	8.00
B1808.5	8.50	117.0	33.0	75.00	6	8.00
B1808.6	8.60	125.0	36.0	81.00	6	10.00
B1808.7	8.70	125.0	36.0	81.00	6	10.00
B1808.8	8.80	125.0	36.0	81.00	6	10.00
B1808.9	8.90	125.0	36.0	81.00	6	10.00

Product	DC	OAL	LCF	LB	NOF	DCON MS
	[mm]	[mm]	[mm]	[mm]		[mm]
B1809.0	9.00	125.0	36.0	81.00	6	10.00
B1809.1	9.10	125.0	36.0	81.00	6	10.00
B1809.2	9.20	125.0	36.0	81.00	6	10.00
B1809.3	9.30	125.0	36.0	81.00	6	10.00
B1809.4	9.40	125.0	36.0	81.00	6	10.00
B1809.5	9.50	125.0	36.0	81.00	6	10.00
B1809.6	9.60	133.0	38.0	87.00	6	10.00
B1809.7	9.70	133.0	38.0	87.00	6	10.00
B1809.8	9.80	133.0	38.0	87.00	6	10.00
B1809.9	9.90	133.0	38.0	87.00	6	10.00
B18010.0	10.00	133.0	38.0	87.00	6	10.00
B18011.0	11.00	142.0	41.0	96.00	6	10.00
B18012.0	12.00	151.0	44.0	105.00	6	10.00
B18013.0	13.00	151.0	44.0	105.00	6	10.00
B18014.0	14.00	160.0	47.0	110.00	8	14.00
B18015.0	15.00	162.0	50.0	112.00	8	14.00
B18016.0	16.00	170.0	52.0	120.00	8	14.00
B18017.0	17.00	175.0	54.0	123.00	8	14.00
B18018.0	18.00	182.0	56.0	130.00	8	14.00
B18019.0	19.00	189.0	58.0	131.00	8	16.00
B18020.0	20.00	195.0	60.0	137.00	8	16.00



B170



HSS-E Straight Shank Machine Reamer - 0.01mm Increments, Bright Finish

Different increment sizes allows you to produce accurate hole sizes and additional hole tolerances. With a left-hand helix and right-hand cutting action, the precision ground geometry provides smooth reaming and improves hole size and surface finish. Suitable for reaming in many materials.

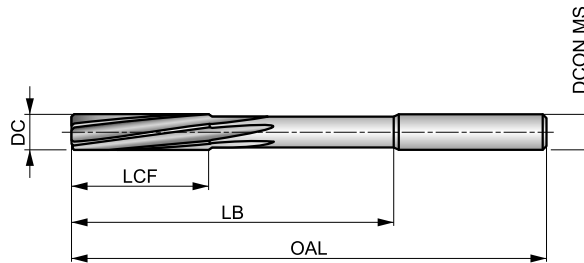

HSS-E	Bright	DIN 212
R		B
$\phi_{.95-5.5}$ $+0.004$ $\phi_{5.51-12}$ $+0.005$		

Workpiece material group suitability, starting values for cutting speed (m/min) and feed Alpha Code. Tables with feed per revolution can be found starting from page 251.

P1.1 ■ 21 C	P1.2 ■ 24 C	P1.3 ■ 25 C	P2.1 ■ 18 C	P2.2 ■ 16 C	P2.3 ■ 14 B	P3.1 ■ 13 B	P3.2 ■ 11 B	P3.3 ■ 9 B	P4.1 ■ 8 B	P4.2 ■ 7 B	P4.3 ■ 5 A	M1.1 ■ 11 C	M1.2 ■ 10 B
M2.1 ■ 9 B	K1.1 ■ 16 E	K1.2 ■ 12 D	K1.3 ■ 9 D	K2.1 ■ 16 C	K2.2 ■ 13 C	K2.3 ■ 10 C	K3.1 ■ 14 C	K3.2 ■ 11 C	N1.1 ■ 24 D	N1.2 ■ 18 F	N1.3 ■ 11 F	N2.1 ■ 27 E	N2.2 ■ 24 E
N2.3 ■ 16 E	N3.1 ■ 47 D	N3.2 ■ 28 E	N3.3 ■ 14 D	N4.1 ■ 30 B									

DCON MS tolerance h9.

Product	DC	OAL	LCF	LB	NOF	DCON MS
	[mm]	[mm]	[mm]	[mm]		[mm]
B170.98	0.98	34.0	5.5	15.00	3	1.00
B170.99	0.99	34.0	5.5	15.00	3	1.00
B1701.0	1.00	34.0	5.5	15.00	3	1.00
B1701.01	1.01	34.0	5.5	15.00	3	1.00
B1701.02	1.02	34.0	5.5	15.00	3	1.00
B1701.03	1.03	34.0	5.5	15.00	3	1.00
B1701.04	1.04	34.0	5.5	15.00	3	1.00
B1701.05	1.05	34.0	5.5	15.00	3	1.00
B1701.49	1.49	40.0	8.0	18.00	3	1.50
B1701.5	1.50	40.0	8.0	18.00	3	1.50
B1701.51	1.51	43.0	9.0	20.00	3	1.60
B1701.52	1.52	43.0	9.0	20.00	3	1.60
B1701.98	1.98	49.0	11.0	24.00	4	2.00
B1701.99	1.99	49.0	11.0	24.00	4	2.00
B1702.0	2.00	49.0	11.0	24.00	4	2.00
B1702.01	2.01	49.0	11.0	24.00	4	2.00
B1702.02	2.02	49.0	11.0	24.00	4	2.00
B1702.03	2.03	49.0	11.0	24.00	4	2.00
B1702.04	2.04	49.0	11.0	24.00	4	2.00
B1702.05	2.05	49.0	11.0	24.00	4	2.00
B1702.49	2.49	57.0	14.0	28.00	4	2.50
B1702.5	2.50	57.0	14.0	28.00	4	2.50
B1702.51	2.51	57.0	14.0	28.00	4	2.50
B1702.52	2.52	57.0	14.0	28.00	4	2.50
B1702.98	2.98	61.0	15.0	32.00	6	3.00
B1702.99	2.99	61.0	15.0	32.00	6	3.00
B1703.0	3.00	61.0	15.0	32.00	6	3.00

Product	DC	OAL	LCF	LB	NOF	DCON MS
	[mm]	[mm]	[mm]	[mm]		[mm]
B1703.01	3.01	65.0	16.0	35.00	6	3.20
B1703.02	3.02	65.0	16.0	35.00	6	3.20
B1703.03	3.03	65.0	16.0	35.00	6	3.20
B1703.04	3.04	65.0	16.0	35.00	6	3.20
B1703.05	3.05	65.0	16.0	35.00	6	3.20
B1703.49	3.49	70.0	18.0	40.00	6	3.50
B1703.5	3.50	70.0	18.0	40.00	6	3.50
B1703.51	3.51	70.0	18.0	40.00	6	3.50
B1703.52	3.52	70.0	18.0	40.00	6	3.50
B1703.98	3.98	75.0	19.0	43.00	6	4.00
B1703.99	3.99	75.0	19.0	43.00	6	4.00
B1704.0	4.00	75.0	19.0	43.00	6	4.00
B1704.01	4.01	75.0	19.0	43.00	6	4.00
B1704.02	4.02	75.0	19.0	43.00	6	4.00
B1704.03	4.03	75.0	19.0	43.00	6	4.00
B1704.04	4.04	75.0	19.0	43.00	6	4.00
B1704.05	4.05	75.0	19.0	43.00	6	4.00
B1704.49	4.49	80.0	21.0	47.00	6	4.50
B1704.5	4.50	80.0	21.0	47.00	6	4.50
B1704.51	4.51	80.0	21.0	47.00	6	4.50
B1704.52	4.52	80.0	21.0	47.00	6	4.50
B1704.98	4.98	86.0	23.0	52.00	6	5.00
B1704.99	4.99	86.0	23.0	52.00	6	5.00
B1705.0	5.00	86.0	23.0	52.00	6	5.00
B1705.01	5.01	86.0	23.0	52.00	6	5.00
B1705.02	5.02	86.0	23.0	52.00	6	5.00
B1705.03	5.03	86.0	23.0	52.00	6	5.00



Product	DC	OAL	LCF	LB	NOF	DCON MS
	[mm]	[mm]	[mm]	[mm]		[mm]
B1705.04	5.04	86.0	23.0	52.00	6	5.00
B1705.05	5.05	86.0	23.0	52.00	6	5.00
B1705.49	5.49	93.0	26.0	57.00	6	5.60
B1705.5	5.50	93.0	26.0	57.00	6	5.60
B1705.51	5.51	93.0	26.0	57.00	6	5.60
B1705.52	5.52	93.0	26.0	57.00	6	5.60
B1705.98	5.98	93.0	26.0	57.00	6	5.60
B1705.99	5.99	93.0	26.0	57.00	6	5.60
B1706.0	6.00	93.0	26.0	57.00	6	5.60
B1706.01	6.01	101.0	28.0	63.00	6	6.30
B1706.02	6.02	101.0	28.0	63.00	6	6.30
B1706.03	6.03	101.0	28.0	63.00	6	6.30
B1706.04	6.04	101.0	28.0	63.00	6	6.30
B1706.05	6.05	101.0	28.0	63.00	6	6.30
B1706.49	6.49	101.0	28.0	63.00	6	6.30
B1706.5	6.50	101.0	28.0	63.00	6	6.30
B1706.51	6.51	101.0	28.0	63.00	6	6.30
B1706.52	6.52	101.0	28.0	63.00	6	6.30
B1706.98	6.98	109.0	31.0	69.00	6	7.10
B1706.99	6.99	109.0	31.0	69.00	6	7.10
B1707.0	7.00	109.0	31.0	69.00	6	7.10
B1707.01	7.01	109.0	31.0	69.00	6	7.10
B1707.02	7.02	109.0	31.0	69.00	6	7.10
B1707.03	7.03	109.0	31.0	69.00	6	7.10
B1707.04	7.04	109.0	31.0	69.00	6	7.10
B1707.05	7.05	109.0	31.0	69.00	6	7.10
B1707.49	7.49	109.0	31.0	69.00	6	7.10
B1707.5	7.50	109.0	31.0	69.00	6	7.10
B1707.51	7.51	117.0	33.0	75.00	6	8.00
B1707.52	7.52	117.0	33.0	75.00	6	8.00
B1707.98	7.98	117.0	33.0	75.00	6	8.00
B1707.99	7.99	117.0	33.0	75.00	6	8.00
B1708.0	8.00	117.0	33.0	75.00	6	8.00
B1708.01	8.01	117.0	33.0	75.00	6	8.00
B1708.02	8.02	117.0	33.0	75.00	6	8.00
B1708.03	8.03	117.0	33.0	75.00	6	8.00
B1708.04	8.04	117.0	33.0	75.00	6	8.00
B1708.05	8.05	117.0	33.0	75.00	6	8.00
B1708.49	8.49	117.0	33.0	75.00	6	8.00
B1708.5	8.50	117.0	33.0	75.00	6	8.00

Product	DC	OAL	LCF	LB	NOF	DCON MS
	[mm]	[mm]	[mm]	[mm]		[mm]
B1708.51	8.51	125.0	36.0	81.00	6	9.00
B1708.52	8.52	125.0	36.0	81.00	6	9.00
B1708.98	8.98	125.0	36.0	81.00	6	9.00
B1708.99	8.99	125.0	36.0	81.00	6	9.00
B1709.0	9.00	125.0	36.0	81.00	6	9.00
B1709.01	9.01	125.0	36.0	81.00	6	9.00
B1709.02	9.02	125.0	36.0	81.00	6	9.00
B1709.03	9.03	125.0	36.0	81.00	6	9.00
B1709.04	9.04	125.0	36.0	81.00	6	9.00
B1709.05	9.05	125.0	36.0	81.00	6	9.00
B1709.49	9.49	125.0	36.0	81.00	6	9.00
B1709.5	9.50	125.0	36.0	81.00	6	9.00
B1709.51	9.51	133.0	38.0	87.00	6	10.00
B1709.52	9.52	133.0	38.0	87.00	6	10.00
B1709.98	9.98	133.0	38.0	87.00	6	10.00
B1709.99	9.99	133.0	38.0	87.00	6	10.00
B17010.0	10.00	133.0	38.0	87.00	6	10.00
B17010.01	10.01	133.0	38.0	87.00	6	10.00
B17010.02	10.02	133.0	38.0	87.00	6	10.00
B17010.03	10.03	133.0	38.0	87.00	6	10.00
B17010.04	10.04	133.0	38.0	87.00	6	10.00
B17010.05	10.05	133.0	38.0	87.00	6	10.00
B17010.49	10.49	133.0	38.0	87.00	6	10.00
B17010.51	10.51	133.0	38.0	87.00	6	10.00
B17010.52	10.52	133.0	38.0	87.00	6	10.00
B17010.98	10.98	142.0	41.0	96.00	6	10.00
B17010.99	10.99	142.0	41.0	96.00	6	10.00
B17011.0	11.00	142.0	41.0	96.00	6	10.00
B17011.01	11.01	142.0	41.0	96.00	6	10.00
B17011.02	11.02	142.0	41.0	96.00	6	10.00
B17011.03	11.03	142.0	41.0	96.00	6	10.00
B17011.04	11.04	142.0	41.0	96.00	6	10.00
B17011.05	11.05	142.0	41.0	96.00	6	10.00
B17011.49	11.49	142.0	41.0	96.00	6	10.00
B17011.5	11.50	142.0	41.0	96.00	6	10.00
B17011.51	11.51	142.0	41.0	96.00	6	10.00
B17011.52	11.52	142.0	41.0	96.00	6	10.00
B17011.98	11.98	151.0	44.0	105.00	6	10.00
B17011.99	11.99	151.0	44.0	105.00	6	10.00
B17012.0	12.00	151.0	44.0	105.00	6	10.00



B157



HSS-E Straight Shank Quick Helix Machine Reamer, H7 Accuracy, Bright Finish

The high spiral left-hand helix and right-hand cutting action gives great performance, particularly when machining non-ferrous materials, such as aluminium. It is also suitable for reaming other materials. The tapered lead makes it easy to locate and centre, ensuring better performance and hole quality.

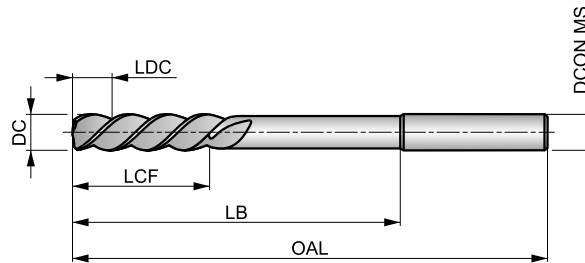

HSS-E	Bright	DIN 212
R		E
H7		

Workpiece material group suitability, starting values for cutting speed (m/min) and feed Alpha Code. Tables with feed per revolution can be found starting from page 251.

P1.1 ■ 21 C	P1.2 ■ 24 C	P1.3 ■ 25 C	P2.1 ■ 18 C	P2.2 ■ 16 C	P3.1 ■ 13 B	P3.2 ■ 11 B	M1.1 ■ 11 C	M1.2 ■ 10 C	M2.1 ■ 9 C	M2.2 ■ 8 B	M2.3 ■ 7 B	N1.1 ■ 28 F	N1.2 ■ 21 F
N1.3 ■ 14 F	N2.1 ■ 31 E	N2.2 ■ 28 E	N2.3 ■ 20 E										

DCON MS tolerance h9.

Product	DC [mm]	OAL [mm]	LCF [mm]	LDC [mm]	LB [mm]	NOF	DCON MS [mm]
B1572.0	2.00	49.0	11.0	3.50	24.00	3	2.00
B1573.0	3.00	61.0	15.0	4.00	32.00	3	3.00
B1574.0	4.00	75.0	19.0	4.00	43.00	3	4.00
B1575.0	5.00	86.0	23.0	4.50	52.00	3	5.00
B1576.0	6.00	93.0	26.0	6.00	57.00	3	5.60
B1577.0	7.00	109.0	31.0	7.00	69.00	3	7.10
B1578.0	8.00	117.0	33.0	9.00	75.00	3	8.00
B1579.0	9.00	125.0	36.0	9.50	81.00	3	9.00
B15710.0	10.00	133.0	38.0	10.00	87.00	3	10.00
B15711.0	11.00	142.0	41.0	10.50	96.00	3	10.00
B15712.0	12.00	151.0	44.0	11.00	105.00	3	10.00
B15713.0	13.00	151.0	44.0	11.50	105.00	3	10.00
B15714.0	14.00	160.0	47.0	12.00	110.00	3	12.50
B15715.0	15.00	162.0	50.0	12.50	112.00	3	12.50
B15716.0	16.00	170.0	52.0	13.00	120.00	3	12.50
B15717.0	17.00	175.0	54.0	13.50	123.00	3	14.00
B15718.0	18.00	182.0	56.0	14.00	130.00	3	14.00
B15719.0	19.00	189.0	58.0	14.50	131.00	3	16.00
B15720.0	20.00	195.0	60.0	15.00	137.00	3	16.00



B161



HSS-E Taper Shank Machine Reamer with H7 Accuracy, Bright Finish

The precision ground left-hand helix and right-hand cutting action, ensures smooth reaming and improved surface finish and hole size. Suitable for reaming in many materials.

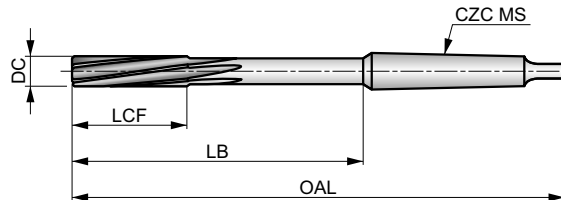

HSS-E	Bright	DIN 208
R		B
H7		

Workpiece material group suitability, starting values for cutting speed (m/min) and feed Alpha Code. Tables with feed per revolution can be found starting from page 251.

P1.1 ■ 21 C	P1.2 ■ 24 C	P1.3 ■ 25 C	P2.1 ■ 18 C	P2.2 ■ 16 C	P2.3 ▣ 14 B	P3.1 ■ 13 B	P3.2 ■ 11 B	P3.3 ▣ 9 B	P4.1 ■ 8 B	P4.2 ▣ 7 B	P4.3 ▣ 5 A	M1.1 ▣ 11 C	M1.2 ▣ 10 B
M2.1 ▣ 9 B	K1.1 ■ 16 E	K1.2 ■ 12 D	K1.3 ▣ 9 D	K2.1 ■ 16 C	K2.2 ■ 13 C	K2.3 ▣ 10 C	K3.1 ■ 14 C	K3.2 ▣ 11 C	N1.1 ▣ 24 F	N1.2 ■ 18 F	N1.3 ■ 11 F	N2.1 ▣ 27 E	N2.2 ■ 24 E
N2.3 ■ 16 E	N3.1 ■ 47 D	N3.2 ■ 28 E	N3.3 ▣ 14 D	N4.1 ▣ 30 B									

Product	DC [mm]	OAL [mm]	LCF [mm]	LB [mm]	NOF	CZC MS
B1613.0	3.00	113.0	15.0	47.50	6	MK 1
B1614.0	4.00	124.0	19.0	58.50	6	MK 1
B1615.0	5.00	133.0	23.0	67.50	6	MK 1
B1616.0	6.00	138.0	26.0	72.50	6	MK 1
B1617.0	7.00	150.0	31.0	84.50	6	MK 1
B1618.0	8.00	156.0	33.0	90.50	6	MK 1
B1619.0	9.00	162.0	36.0	96.50	6	MK 1
B16110.0	10.00	168.0	38.0	102.50	6	MK 1
B16111.0	11.00	175.0	41.0	109.50	6	MK 1
B16112.0	12.00	182.0	44.0	116.50	6	MK 1
B16113.0	13.00	182.0	44.0	116.50	6	MK 1
B16114.0	14.00	189.0	47.0	123.50	8	MK 1
B16115.0	15.00	204.0	50.0	124.00	8	MK 2
B16116.0	16.00	210.0	52.0	130.00	8	MK 2
B16117.0	17.00	214.0	54.0	134.00	8	MK 2
B16118.0	18.00	219.0	56.0	139.00	8	MK 2
B16119.0	19.00	223.0	58.0	143.00	8	MK 2
B16120.0	20.00	228.0	60.0	148.00	8	MK 2
B16121.0	21.00	232.0	62.0	152.00	8	MK 2
B16122.0	22.00	237.0	64.0	157.00	8	MK 2
B16123.0	23.00	241.0	66.0	161.00	8	MK 2
B16124.0	24.00	268.0	68.0	169.00	8	MK 3

Product	DC [mm]	OAL [mm]	LCF [mm]	LB [mm]	NOF	CZC MS
B16125.0	25.00	268.0	68.0	169.00	8	MK 3
B16126.0	26.00	273.0	70.0	174.00	8	MK 3
B16127.0	27.00	277.0	71.0	178.00	10	MK 3
B16128.0	28.00	277.0	71.0	178.00	10	MK 3
B16129.0	29.00	281.0	73.0	182.00	10	MK 3
B16130.0	30.00	281.0	73.0	182.00	10	MK 3
B16131.0	31.00	285.0	75.0	186.00	10	MK 3
B16132.0	32.00	317.0	77.0	193.00	10	MK 4
B16133.0	33.00	317.0	77.0	193.00	10	MK 4
B16134.0	34.00	321.0	78.0	197.00	10	MK 4
B16135.0	35.00	321.0	78.0	197.00	10	MK 4
B16136.0	36.00	325.0	79.0	201.00	10	MK 4
B16138.0	38.00	329.0	81.0	205.00	10	MK 4
B16140.0	40.00	329.0	81.0	205.00	10	MK 4
B16142.0	42.00	333.0	82.0	209.00	12	MK 4
B16144.0	44.00	336.0	83.0	212.00	12	MK 4
B16145.0	45.00	336.0	83.0	212.00	12	MK 4
B16146.0	46.00	340.0	84.0	216.00	12	MK 4
B16147.0	47.00	340.0	84.0	216.00	12	MK 4
B16148.0	48.00	344.0	86.0	220.00	12	MK 4
B16150.0	50.00	344.0	86.0	220.00	12	MK 4



B101



HSS-E Taper Shank Machine Reamer with H7 Accuracy

Taper Shank machine reamer according to BS 328. The precision ground left-hand helix and right-hand cutting action, ensures smooth reaming and improved surface finish and hole size. Suitable for reaming in many materials.

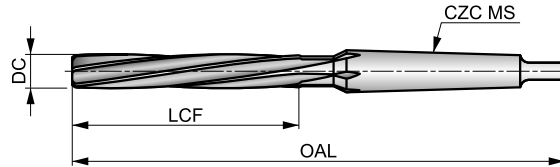

HSS-E	Bright ST	BS 328
R		B
H7		

Workpiece material group suitability, starting values for cutting speed (m/min) and feed Alpha Code. Tables with feed per revolution can be found starting from page 251.

P1.1 ■ 15 C	P1.2 ■ 16 C	P1.3 ■ 17 C	P2.1 ■ 13 C	P2.2 ■ 11 C	P2.3 ▣ 10 B	P3.1 ■ 7 B	P3.2 ■ 6 B	P3.3 ▣ 5 B	P4.1 ■ 4 B	P4.2 ▣ 4 B	P4.3 ▣ 3 A	M1.1 ▣ 7 B	M1.2 ▣ 6 A
K1.1 ■ 14 E	K1.2 ■ 10 D	K1.3 ▣ 8 D	K2.1 ■ 12 C	K2.2 ■ 10 C	K2.3 ▣ 8 C	K3.1 ■ 11 C	K3.2 ▣ 8 C	N1.1 ▣ 23 F	N1.2 ■ 17 F	N1.3 ■ 9 F	N2.1 ▣ 25 E	N2.2 ■ 18 E	N2.3 ■ 14 E
N3.1 ■ 34 D	N3.2 ■ 20 E	N3.3 ▣ 10 D	N4.1 ▣ 22 B										

Product	DC	DC	OAL	LCF	NOF	CZC MS
	[inch]	[mm]	[mm]	[mm]		
B1013.0	—	3.00	112.0	33.0	4	MK 1
B1011/8	1/8	3.18	112.0	33.0	4	MK 1
B1013.5	—	3.50	115.0	35.0	6	MK 1
B1014.0	—	4.00	117.0	38.0	6	MK 1
B1014.5	—	4.50	120.0	41.0	6	MK 1
B1013/16	3/16	4.76	124.0	44.0	6	MK 1
B1015.0	—	5.00	124.0	44.0	6	MK 1
B1015.5	—	5.50	127.0	47.0	6	MK 1
B1016.0	—	6.00	127.0	47.0	6	MK 1
B1011/4	1/4	6.35	130.0	50.0	6	MK 1
B1016.5	—	6.50	130.0	50.0	6	MK 1
B1017.0	—	7.00	134.0	54.0	6	MK 1
B1015/16	5/16	7.94	138.0	58.0	6	MK 1
B1018.0	—	8.00	138.0	58.0	6	MK 1
B1018.5	—	8.50	138.0	58.0	6	MK 1
B1019.0	—	9.00	142.0	62.0	6	MK 1
B1019.5	—	9.50	142.0	62.0	6	MK 1
B1013/8	3/8	9.52	146.0	66.0	6	MK 1
B10110.0	—	10.00	146.0	66.0	6	MK 1
B10110.5	—	10.50	146.0	66.0	6	MK 1
B10111.0	—	11.00	151.0	71.0	6	MK 1
B1017/16	7/16	11.11	151.0	71.0	6	MK 1
B10112.0	—	12.00	156.0	76.0	6	MK 1
B10112.5	—	12.50	156.0	76.0	6	MK 1
B1011/2	1/2	12.70	156.0	76.0	6	MK 1
B10113.0	—	13.00	156.0	76.0	6	MK 1
B10113.5	—	13.50	161.0	81.0	6	MK 1
B10114.0	—	14.00	161.0	81.0	8	MK 1

Product	DC	DC	OAL	LCF	NOF	CZC MS
	[inch]	[mm]	[mm]	[mm]		
B1019/16	9/16	14.29	181.0	81.0	8	MK 2
B10114.5	—	14.50	181.0	81.0	8	MK 2
B10115.0	—	15.00	181.0	81.0	8	MK 2
B10115.5	—	15.50	187.0	87.0	8	MK 2
B1015/8	5/8	15.88	187.0	87.0	8	MK 2
B10116.0	—	16.00	187.0	87.0	8	MK 2
B10116.5	—	16.50	187.0	87.0	8	MK 2
B10117.0	—	17.00	187.0	87.0	8	MK 2
B10118.0	—	18.00	193.0	93.0	8	MK 2
B10119.0	—	19.00	193.0	93.0	8	MK 2
B1013/4	3/4	19.05	200.0	100.0	8	MK 2
B10120.0	—	20.00	200.0	100.0	8	MK 2
B10113/16	13/16	20.64	200.0	100.0	8	MK 2
B10121.0	—	21.00	200.0	100.0	8	MK 2
B10122.0	—	22.00	207.0	107.0	8	MK 2
B1017/8	7/8	22.22	207.0	107.0	8	MK 2
B10123.0	—	23.00	207.0	107.0	8	MK 2
B10124.0	—	24.00	242.0	115.0	8	MK 3
B10125.0	—	25.00	242.0	115.0	10	MK 3
B1011	1"	25.40	242.0	115.0	10	MK 3
B10126.0	—	26.00	242.0	115.0	10	MK 3
B10127.0	—	27.00	251.0	124.0	10	MK 3
B10128.0	—	28.00	251.0	124.0	10	MK 3
B1011.1/8	1.1/8	28.58	251.0	124.0	10	MK 3
B10129.0	—	29.00	251.0	124.0	10	MK 3
B10130.0	—	30.00	251.0	124.0	10	MK 3
B10131.0	—	31.00	260.0	133.0	10	MK 3
B1011.1/4	1.1/4	31.75	260.0	133.0	10	MK 3



Product	DC	DC	OAL	LCF	NOF	CZC MS
	[inch]	[mm]	[mm]	[mm]		
B10132.0	–	32.00	293.0	133.0	10	MK 4
B10134.0	–	34.00	302.0	142.0	10	MK 4
B1011.3/8	1.3/8	34.93	302.0	142.0	10	MK 4
B10135.0	–	35.00	302.0	142.0	10	MK 4
B10136.0	–	36.00	302.0	142.0	10	MK 4
B10137.0	–	37.00	302.0	142.0	10	MK 4
B10138.0	–	38.00	312.0	152.0	10	MK 4
B1011.1/2	1.1/2	38.10	312.0	152.0	10	MK 4
B10139.0	–	39.00	312.0	152.0	10	MK 4
B10140.0	–	40.00	312.0	152.0	10	MK 4
B10141.0	–	41.00	312.0	152.0	10	MK 4

Product	DC	DC	OAL	LCF	NOF	CZC MS
	[inch]	[mm]	[mm]	[mm]		
B10142.0	–	42.00	312.0	152.0	10	MK 4
B10143.0	–	43.00	323.0	163.0	10	MK 4
B10144.0	–	44.00	323.0	163.0	10	MK 4
B1011.3/4	1.3/4	44.45	323.0	163.0	10	MK 4
B10145.0	–	45.00	323.0	163.0	12	MK 4
B10146.0	–	46.00	323.0	163.0	12	MK 4
B10147.0	–	47.00	323.0	163.0	12	MK 4
B10148.0	–	48.00	334.0	174.0	12	MK 4
B10150.0	–	50.00	334.0	174.0	12	MK 4
B1012	2"	50.80	334.0	174.0	12	MK 4



B121



HSS Taper Shank Machine Bridge Reamer

Designed to re-align holes in large fabrications, where two or more workpieces are joined, before bolting or riveting them. The small Pilot diameter from the 1 to 10 ratio taper lead simplifies the need to locate and align the tool in pre-drilled holes. Suitable for reaming in many materials.

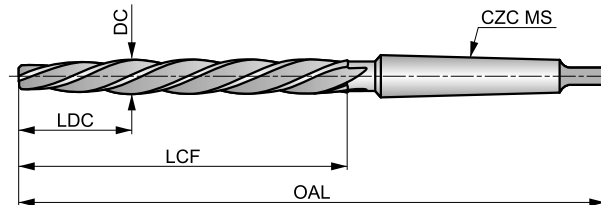

HSS	Bright ST	DIN 311
R		k11

Workpiece material group suitability, starting values for cutting speed (m/min) and feed Alpha Code. Tables with feed per revolution can be found starting from page 251.

P1.1 ■ 15 C	P1.2 ■ 16 C	P1.3 ■ 17 C	P2.1 ■ 13 C	P2.2 ■ 11 C	P2.3 ▣ 10 B	P3.1 ■ 7 B	P3.2 ■ 6 B	P3.3 ▣ 5 B	P4.1 ■ 4 B	P4.2 ▣ 4 B	P4.3 ▣ 3 A	K1.1 ■ 14 E	K1.2 ■ 10 D
K1.3 ▣ 8 D	K2.1 ■ 12 C	K2.2 ■ 10 C	K2.3 ▣ 8 C	K3.1 ▣ 11 C	K3.2 ▣ 8 C	N1.1 ▣ 23 F	N1.2 ■ 17 F	N1.3 ■ 9 F	N2.1 ▣ 21 E	N2.2 ■ 18 E	N2.3 ▣ 14 E	N3.1 ■ 34 D	N3.2 ■ 20 E
N3.3 ▣ 10 D	N4.1 ▣ 21 B												

With 1:10 starting taper (LDC).

Product	DC [mm]	OAL [mm]	LCF [mm]	LDC [mm]	NOF	CZC MS
B12110.0	10.00	171.0	95.0	30.00	4	MK 1
B12111.0	11.00	176.0	100.0	33.00	4	MK 1
B12112.0	12.00	199.0	105.0	39.00	4	MK 2
B12113.0	13.00	199.0	105.0	39.00	4	MK 2
B12114.0	14.00	209.0	115.0	42.00	4	MK 2
B12115.0	15.00	219.0	125.0	45.00	4	MK 2
B12116.0	16.00	229.0	135.0	48.00	4	MK 2
B12117.0	17.00	251.0	135.0	51.00	4	MK 3
B12118.0	18.00	261.0	145.0	58.00	4	MK 3
B12119.0	19.00	261.0	145.0	58.00	4	MK 3
B12120.0	20.00	271.0	155.0	62.00	4	MK 3
B12121.0	21.00	271.0	155.0	62.00	4	MK 3
B12122.0	22.00	281.0	165.0	66.00	4	MK 3
B12123.0	23.00	281.0	165.0	66.00	4	MK 3
B12124.0	24.00	296.0	180.0	72.00	4	MK 3
B12125.0	25.00	296.0	180.0	72.00	4	MK 3
B12126.0	26.00	296.0	180.0	72.00	4	MK 3
B12130.0	30.00	311.0	195.0	78.00	5	MK 3



B954



HSS-E Taper Shank Taper Pin Machine Reamer 1:50 Taper

Smooth reaming with improved accuracy and performance is achieved through the specially designed high spiral left-hand helix and right-hand cutting. Designed to finish tapered holes and accepts standard 1 to 50 ratio metric taper pins. Suitable for reaming in many materials.

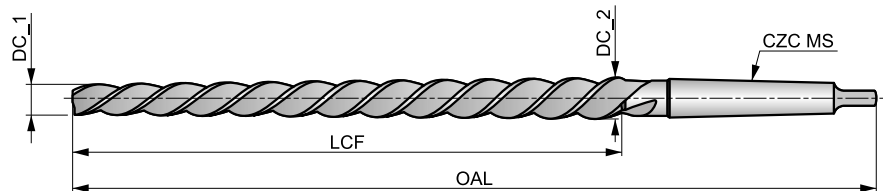

HSS-E	Bright	DIN 2180
R	1:50	

Workpiece material group suitability, starting values for cutting speed (m/min) and feed Alpha Code. Tables with feed per revolution can be found starting from page 251.

P1.1 ■ 10 B	P1.2 ■ 12 B	P1.3 ■ 13 B	P2.1 ■ 9 B	P2.2 ■ 8 B	P2.3 ▣ 6 A	P3.1 ■ 7 A	P3.2 ■ 6 A	P3.3 ▣ 3 A	P4.1 ■ 4 A	P4.2 ▣ 3 A	P4.3 ▣ 2 A	M1.1 ▣ 11 C	M1.2 ▣ 10 B
M2.1 ▣ 9 B	M2.2 ▣ 8 B	K1.1 ■ 10 C	K1.2 ■ 6 B	K1.3 ▣ 4 B	K2.1 ■ 8 A	K2.2 ■ 6 A	K2.3 ▣ 4 A	K3.1 ■ 11 A	K3.2 ▣ 8 A	N1.1 ▣ 14 F	N1.2 ■ 12 F	N1.3 ■ 9 F	N2.1 ■ 16 E
N2.2 ■ 14 E	N2.3 ▣ 10 E	N3.1 ■ 22	N3.2 ■ 14 E	N3.3 ▣ 6	N4.1 ▣ 22 B								

Product	nom d	DC_1	DC_2	OAL	LCF	NOF	CZC MS
		[mm]	[mm]	[mm]	[mm]		
B9545.0	5.0	4.90	6.36	155.0	73.0	3	MK 1
B9546.0	6.0	5.90	8.00	187.0	105.0	3	MK 1
B9548.0	8.0	7.90	10.80	227.0	145.0	3	MK 1
B95410.0	10.0	9.90	13.40	257.0	175.0	3	MK 1
B95412.0	12.0	11.80	16.00	315.0	210.0	3	MK 2
B95413.0	13.0	12.86	16.74	295.0	194.0	3	MK 2
B95414.0	14.0	13.86	17.74	295.0	194.0	3	MK 2
B95416.0	16.0	15.80	20.40	335.0	230.0	3	MK 2
B95420.0	20.0	19.80	24.80	377.0	250.0	3	MK 3
B95425.0	25.0	24.70	30.70	427.0	300.0	3	MK 3
B95430.0	30.0	29.70	36.10	475.0	320.0	4	MK 4



B955



HSS-E Shell Reamer with H7 Accuracy, Bright and Steam Tempered

Shell reamers to be used with an arbor that fits the hole in the reamer. They are precision ground with a left-hand helix and right-hand cutting to provide smooth reaming. With a 45° bevel lead for accurate location and centering in the hole to improve performance and hole quality. Suitable for reaming in many materials.

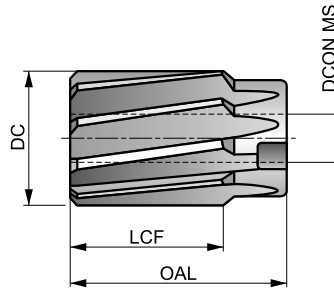

HSS-E	Bright ST	DIN 219
R	B	H7

Workpiece material group suitability, starting values for cutting speed (m/min) and feed Alpha Code. Tables with feed per revolution can be found starting from page 251.

P1.1 ■ 15 C	P1.2 ■ 16 C	P1.3 ■ 17 C	P2.1 ■ 13 C	P2.2 ■ 11 C	P2.3 ▧ 10 B	P3.1 ■ 7 B	P3.2 ■ 6 B	P3.3 ▧ 5 B	P4.1 ■ 4 B	P4.2 ▧ 4 B	P4.3 ▧ 3 A	M1.1 ▧ 11 C	M1.2 ▧ 10 B
M2.1 ▧ 9 B	K1.1 ■ 10 E	K1.2 ■ 8 D	K1.3 ▧ 7 D	K2.1 ■ 10 C	K2.2 ■ 9 C	K2.3 ▧ 6 C	K3.1 ▧ 10 C	K3.2 ▧ 7 C	N1.1 ▧ 17 F	N1.2 ■ 17 F	N1.3 ■ 10 F	N2.1 ▧ 23 E	N2.2 ■ 21 E
N2.3 ■ 13 E	N3.1 ■ 34 D	N3.2 ■ 20 E	N3.3 ▧ 10 D	N4.1 ▧ 24 C									

Product	DC [mm]	OAL [mm]	LCF [mm]	NOF	DCON MS [mm]
B95525.0	25.00	45.0	32.0	8	13.00
B95526.0	26.00	45.0	32.0	8	13.00
B95527.0	27.00	45.0	32.0	8	13.00
B95528.0	28.00	45.0	32.0	8	13.00
B95529.0	29.00	45.0	32.0	8	13.00
B95530.0	30.00	45.0	32.0	8	13.00
B95531.0	31.00	50.0	36.0	10	16.00
B95532.0	32.00	50.0	36.0	10	16.00
B95534.0	34.00	50.0	36.0	10	16.00
B95535.0	35.00	50.0	36.0	10	16.00
B95536.0	36.00	56.0	40.0	10	19.00
B95537.0	37.00	56.0	40.0	10	19.00
B95538.0	38.00	56.0	40.0	10	19.00
B95540.0	40.00	56.0	40.0	10	19.00

Product	DC [mm]	OAL [mm]	LCF [mm]	NOF	DCON MS [mm]
B95542.0	42.00	56.0	40.0	10	19.00
B95544.0	44.00	63.0	45.0	12	22.00
B95545.0	45.00	63.0	45.0	12	22.00
B95548.0	48.00	63.0	45.0	12	22.00
B95550.0	50.00	63.0	45.0	12	22.00
B95552.0	52.00	71.0	50.0	12	27.00
B95555.0	55.00	71.0	50.0	12	27.00
B95558.0	58.00	71.0	50.0	12	27.00
B95560.0	60.00	71.0	50.0	12	27.00
B95565.0	65.00	80.0	56.0	14	32.00
B95570.0	70.00	80.0	56.0	14	32.00
B95575.0	75.00	90.0	63.0	14	40.00
B95580.0	80.00	90.0	63.0	14	40.00



B956



Shell Reamer Arbor for B955

Arbor used to hold shell reamers in machine applications. It has a taper shank to be held directly in the machine spindle. For arbor spare parts (drivers, nuts and washers) please see Dormer's B957 range for availability.

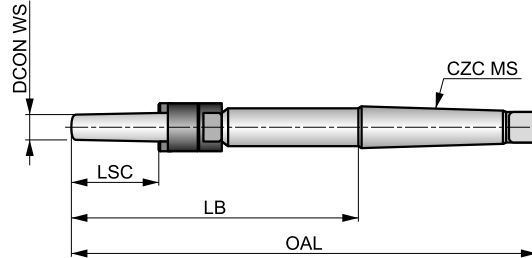

HSS-E



Bright

DIN
217



Product	DCON WS	OAL	LSC	LB	CZC MS
	[mm]	[mm]	[mm]	[mm]	
B95613.0	13.00	250.0	45	151.00	MK 3
B95616.0	16.00	261.0	50	162.00	MK 3
B95619.0	19.00	298.0	56	174.00	MK 4
B95622.0	22.00	312.0	63	188.00	MK 4
B95627.0	27.00	359.0	71	203.00	MK 5
B95632.0	32.00	376.0	80	220.00	MK 5
B95640.0	40.00	396.0	90	240.00	MK 5



B957



Spare Parts for B956 Arbors

The B957 range of spare parts for B956 arbors consist of drivers, nuts and washers. They can be purchased individually by size, ensuring continued use safely and securely. The B957 drivers, nuts and washers are manufactured to required standards.

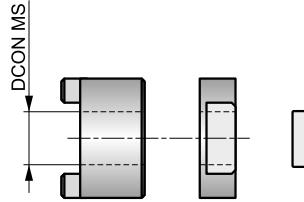

Product	Nr.	DCON MS
		[mm]
B957N3DRIVER	3	13.00
B957N3NUT	3	–
B957N3WASHER	3	–
B957N4DRIVER	4	16.00
B957N4NUT	4	–
B957N4WASHER	4	–
B957N5DRIVER	5	19.00
B957N5NUT	5	–
B957N5WASHER	5	–
B957N6DRIVER	6	22.00
B957N6NUT	6	–
B957N6WASHER	6	–
B957N7DRIVER	7	27.00
B957N7NUT	7	–
B957N7WASHER	7	–
B957N8DRIVER	8	32.00
B957N8NUT	8	–
B957N8WASHER	8	–
B957N9DRIVER	9	40.00
B957N9NUT	9	–
B957N9WASHER	9	–



G400



Carbide Straight Shank 90° Countersink, Bright Finish

High performance 90° countersink with bright finish, designed for use with CNC machines where high productivity and quality are required. Can be used for chamfering holes in hard and abrasive materials. A 90° angle is designed to chamfer holes for standard fasteners with 90° heads.

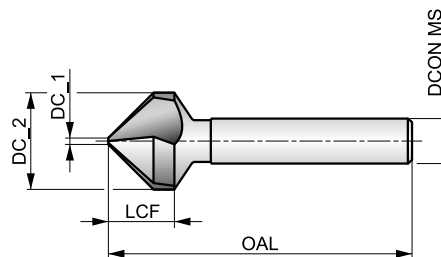

HM	Bright	DIN 335C
R	90°	

Workpiece material group suitability, starting values for cutting speed (m/min) and feed Alpha Code. Tables with feed per revolution can be found starting from page 251.

P1.1 ■ 64 E	P1.2 ■ 72 E	P1.3 ■ 74 E	P2.1 ■ 55 E	P2.2 ■ 48 D	P2.3 ■ 43 B	P3.1 ■ 45 D	P3.2 ■ 36 D	P3.3 ■ 30 B	P4.1 ■ 26 D	P4.2 ■ 23 B	P4.3 ■ 18 A	M1.1 ■ 24 C	M1.2 ■ 21 C
M2.1 ■ 22 C	M2.2 ▣ 18 C	M2.3 ▣ 15 B	M3.1 ■ 20 B	M3.2 ▣ 17 B	M3.3 ▣ 15 B	M4.1 ▣ 15 A	M4.2 ▣ 13 A	K1.1 ■ 45 F	K1.2 ■ 33 D	K1.3 ■ 25 D	K2.1 ■ 46 C	K2.2 ■ 37 C	K2.3 ▣ 30 C
K3.1 ■ 41 C	K3.2 ■ 31 C	K3.3 ▣ 25 C	K4.1 ■ 38 C	K4.2 ■ 28 C	K4.3 ■ 21 C	K4.4 ▣ 18 C	K4.5 ▣ 15 C	K5.1 ■ 43 C	K5.2 ■ 32 C	K5.3 ■ 25 C	N1.1 ▣ 75 G	N1.2 ■ 55 G	N1.3 ■ 40 F
N2.1 ■ 40 F	N2.2 ■ 36 F	N2.3 ■ 26 F	N3.1 ■ 42 F	N3.2 ■ 25 F	N3.3 ▣ 13 D	N4.3 ■ 17 E	S1.1 ■ 12 C	S1.2 ■ 10 A	S1.3 ▣ 9 A	S2.1 ■ 8 B	S2.2 ▣ 7 A	S3.1 ■ 6 B	S3.2 ▣ 5 A
S4.1 ■ 5 B	S4.2 ▣ 4 A	H1.1 ■ 12 A	H2.1 ■ 7 A	H2.2 ▣ 6 B	H3.1 ■ 8 A	H3.2 ▣ 7 B	H4.1 ■ 5 A	H4.2 ▣ 4 B					

DCON MS tolerance h6.

Product	DC_2 [mm]	DC_1 [mm]	LCF [mm]	OAL [mm]	DCON MS [mm]	NOF
G4006.3	6.30	1.50	5.0	45.0	5.00	3
G4008.3	8.30	2.00	6.0	50.0	6.00	3
G40010.4	10.40	2.50	7.1	50.0	6.00	3
G40012.4	12.40	2.80	8.0	56.0	8.00	3
G40016.5	16.50	3.20	10.0	60.0	10.00	3
G40020.5	20.50	3.50	12.5	63.0	10.00	3
G40025.0	25.00	3.80	15.0	67.0	10.00	3
G40031.0	31.00	4.20	18.0	71.0	12.00	3



G135



HSS Straight Shank 60° Countersink, Bright Finish

With a 60° angle to chamfer holes for special fasteners and removing burrs from drilled holes in diameters up to 25.0 mm. For use in both machine and hand-held operations. Suitable to chamfer holes in many materials.

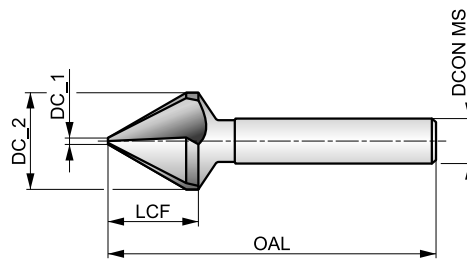

HSS	Bright	DIN 334C
R	60°	

Workpiece material group suitability, starting values for cutting speed (m/min) and feed Alpha Code. Tables with feed per revolution can be found starting from page 251.

P1.1 ■ 23 E	P1.2 ■ 26 E	P1.3 ■ 27 E	P2.1 ■ 20 E	P2.2 ■ 18 D	P2.3 ▧ 16 B	P3.1 ■ 16 D	P3.2 ▧ 13 D	P3.3 ▧ 11 B	P4.1 ■ 10 D	P4.2 ▧ 8 B	M1.1 ▧ 8 C	M1.2 ▧ 6 C	M2.1 ▧ 7 C
M2.2 ▧ 16 C	K1.1 ▧ 20 F	K1.2 ▧ 15 D	K2.1 ▧ 21 C	K2.2 ▧ 17 C	K3.1 ▧ 18 C	K3.2 ▧ 14 C	K5.1 ▧ 19 C	K5.2 ▧ 15 C	N1.1 ▧ 40 G	N1.2 ■ 30 G	N1.3 ▧ 20 F	N2.1 ■ 20 F	N2.2 ▧ 18 F
N3.1 ■ 21 F	N3.2 ■ 12 F	N3.3 ▧ 6 D	N4.1 ▧ 40 G	N4.2 ▧ 35 G									

DCON MS tolerance h9.

Product	DC_2 [mm]	DC_1 [mm]	LCF [mm]	OAL [mm]	DCON MS [mm]	NOF
G1356.3	6.30	1.60	6.8	45.0	5.00	3
G1358.0	8.00	2.00	8.5	50.0	6.00	3
G13510.0	10.00	2.50	7.6	50.0	6.00	3
G13512.5	12.50	3.20	11.7	56.0	8.00	3
G13516.0	16.00	4.00	14.5	63.0	10.00	3
G13520.0	20.00	5.00	17.5	67.0	10.00	3
G13525.0	25.00	6.30	20.5	71.0	10.00	3



G335



HSS Straight Shank 60° Countersink, TiN Coated

For 60° countersink chamfer holes to accommodate special fasteners and removing burrs from drilled holes. TiN coating improves performance and extends tool life. Versatile tool that can be used in both hand-held and machine applications. Suitable to chamfer holes in many materials.

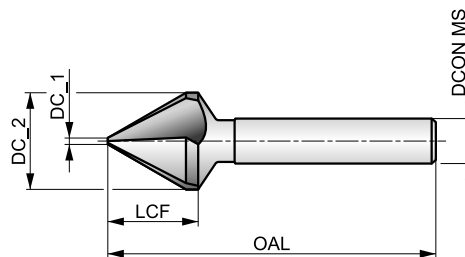

HSS	TiN	DIN 334C
R	60°	

Workpiece material group suitability, starting values for cutting speed (m/min) and feed Alpha Code. Tables with feed per revolution can be found starting from page 251.

P1.1 ■ 33 E	P1.2 ■ 37 E	P1.3 ■ 38 E	P2.1 ■ 28 E	P2.2 ■ 25 D	P2.3 ■ 22 B	P3.1 ■ 23 D	P3.2 ■ 18 D	P3.3 ■ 15 B	P4.1 ■ 13 D	P4.2 ■ 11 B	P4.3 ■ 9 B	M1.1 ■ 10 C	M1.2 ■ 8 C
M2.1 ■ 19 C	M3.1 ■ 8 B	K1.1 ■ 34 F	K1.2 ■ 25 D	K1.3 ■ 19 D	K2.1 ■ 35 C	K2.2 ■ 28 C	K2.3 ■ 23 C	K3.1 ■ 31 C	K3.2 ■ 24 C	K3.3 ■ 19 C	K4.1 ■ 29 C	K4.2 ■ 22 C	K4.3 ■ 16 C
K5.1 ■ 32 C	K5.2 ■ 24 C	K5.3 ■ 19 C	N1.1 ■ 53 G	N1.2 ■ 40 G	N1.3 ■ 27 F	N2.1 ■ 27 F	N2.2 ■ 24 F	N2.3 ■ 17 F	N3.1 ■ 28 F	N3.2 ■ 16 F	N3.3 ■ 8 D	N4.1 ■ 58 G	N4.2 ■ 50 G

DCON MS tolerance h9.

Product	DC_2 [mm]	DC_1 [mm]	LCF [mm]	OAL [mm]	DCON MS [mm]	NOF
G3356.3	6.30	1.60	6.8	45.0	5.00	3
G3358.0	8.00	2.00	8.5	50.0	6.00	3
G33510.0	10.00	2.50	7.6	50.0	6.00	3
G33512.5	12.50	3.20	11.7	56.0	8.00	3
G33516.0	16.00	4.00	14.5	63.0	10.00	3
G33520.0	20.00	5.00	17.5	67.0	10.00	3
G33525.0	25.00	6.30	20.5	71.0	10.00	3



G137



HSS Taper Shank 60° Countersink, Bright Finish

Countersinks with bright finish and a 60° angle to chamfer holes for special fasteners and removing burrs from drilled holes. Taper shank design allows the tool to be used in machine applications where it is held directly in the spindle. Suitable to chamfer holes in many materials.

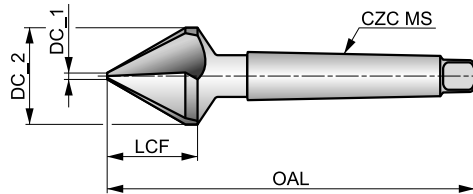

HSS	Bright	DIN 334D
R	60°	

Workpiece material group suitability, starting values for cutting speed (m/min) and feed Alpha Code. Tables with feed per revolution can be found starting from page 251.

P1.1 ■ 23 E	P1.2 ■ 26 E	P1.3 ■ 27 E	P2.1 ■ 20 E	P2.2 ■ 18 D	P2.3 ▧ 16 B	P3.1 ■ 16 D	P3.2 ▧ 13 D	P3.3 ▧ 11 B	P4.1 ■ 10 D	P4.2 ▧ 8 B	M1.1 ▧ 8 C	M1.2 ▧ 6 C	M2.1 ▧ 7 C
M2.2 ▧ 6 C	K1.1 ▧ 20 F	K1.2 ▧ 15 D	K2.1 ▧ 21 C	K2.2 ▧ 17 C	K3.1 ▧ 18 C	K3.2 ▧ 14 C	K5.1 ▧ 19 C	K5.2 ▧ 15 C	N1.1 ▧ 40 G	N1.2 ■ 30 G	N1.3 ▧ 20 F	N2.1 ■ 20 F	N2.2 ▧ 18 F
N3.1 ■ 21 F	N3.2 ■ 12 F	N3.3 ▧ 6 D	N4.1 ▧ 40 G	N4.2 ▧ 35 G									

Product	DC_2 [mm]	DC_1 [mm]	LCF [mm]	OAL [mm]	CZC MS	NOF
G13716.0	16.00	4.00	14.5	90.0	MK 1	3
G13720.0	20.00	5.00	17.5	106.0	MK 2	3
G13725.0	25.00	6.30	20.0	112.0	MK 2	3
G13731.5	31.50	10.00	23.0	118.0	MK 2	3
G13740.0	40.00	12.50	28.5	150.0	MK 3	3
G13750.0	50.00	16.00	36.0	160.0	MK 3	3
G13763.0	63.00	20.00	43.0	190.0	MK 4	3
G13780.0	80.00	25.00	54.0	200.0	MK 4	3



G154



HSS Straight Shank 82° Countersink, Bright Finish

An 82° Countersink for flat head cap screws and to chamfer holes. Versatile tool that can be used in both hand-held and machine applications. Suitable to chamfer holes in many materials.

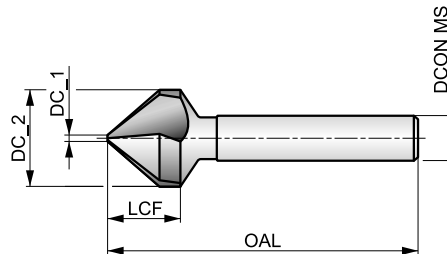

HSS	Bright	DIN 335C
R	82°	

Workpiece material group suitability, starting values for cutting speed (m/min) and feed Alpha Code. Tables with feed per revolution can be found starting from page 251.

P1.1 ■ 23 E	P1.2 ■ 26 E	P1.3 ■ 27 E	P2.1 ■ 20 E	P2.2 ■ 18 D	P2.3 ▧ 16 B	P3.1 ■ 16 D	P3.2 ■ 13 D	P3.3 ▧ 11 B	P4.1 ■ 10 D	P4.2 ▧ 8 B	M1.1 ▧ 8 C	M1.2 ▧ 6 C	M2.1 ▧ 7 C
M2.2 ▧ 16 C	K1.1 ▧ 20 F	K1.2 ▧ 15 D	K2.1 ▧ 21 C	K2.2 ▧ 17 C	K3.1 ▧ 18 C	K3.2 ▧ 14 C	K5.1 ▧ 14 C	K5.2 ▧ 10 C	N1.1 ▧ 40 G	N1.2 ■ 30 G	N1.3 ▧ 20 F	N2.1 ■ 20 F	N2.2 ▧ 18 F
N3.1 ■ 21 F	N3.2 ■ 12 F	N3.3 ▧ 6 D	N4.1 ▧ 40 G	N4.2 ▧ 35 G									

DCON MS tolerance h9.

Product	DC_2 [mm]	DC_1 [mm]	LCF [mm]	OAL [mm]	DCON MS [mm]	NOF
G1546.3	6.30	1.50	5.5	45.0	5.00	3
G1548.3	8.30	2.00	6.5	50.0	6.00	3
G15410.4	10.40	2.50	7.6	50.0	6.00	3
G15412.4	12.40	2.80	8.5	56.0	8.00	3
G15416.5	16.50	3.20	10.5	60.0	10.00	3
G15420.5	20.50	3.50	13.0	63.0	10.00	3
G15425.0	25.00	3.80	15.5	67.0	10.00	3



G129



HSS Straight Shank Single Flute 90° Countersink, Bright Finish

A 90° Countersink with bright finish to chamfer and for removing burrs from drilled holes. The single-flute design reduces vibration and chatter for a smooth chamfering operation. Suitable to chamfer holes in mild steels and medium strength non-ferrous materials, such as aluminium.

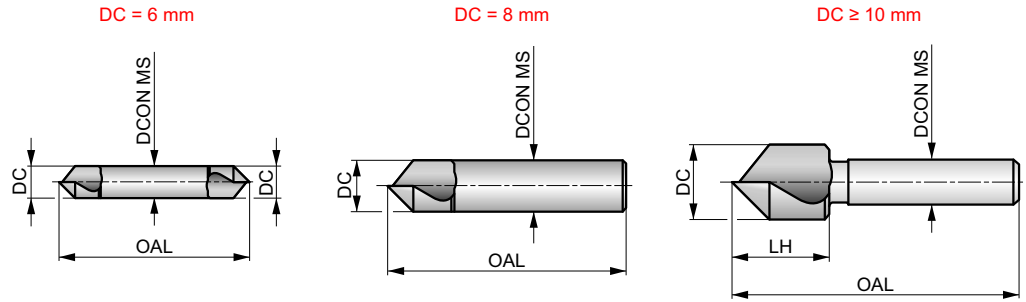

HSS	Bright	DORMER
R	90°	

Workpiece material group suitability, starting values for cutting speed (m/min) and feed Alpha Code. Tables with feed per revolution can be found starting from page 251.

P1.1 ■ 21 D	P1.2 ■ 24 D	P1.3 ■ 25 D	P2.1 ■ 18 D	P2.2 ■ 16 C	P2.3 ▣ 14 A	P3.1 ■ 13 B	P3.2 ▣ 11 B	M1.1 ▣ 8 B	M1.2 ▣ 6 B	M2.1 ▣ 7 B	K1.1 ▣ 18 D	K1.2 ▣ 13 C	K2.1 ▣ 19 A
K2.2 ▣ 15 A	K3.1 ▣ 16 A	K3.2 ▣ 12 A	N1.1 ■ 34 D	N1.2 ■ 25 D	N1.3 ▣ 16 C	N2.1 ▣ 16 C	N2.2 ▣ 14 C	N3.1 ■ 17 C	N3.2 ■ 9 C	N3.3 ▣ 5 B	N4.1 ▣ 35 D	N4.2 ▣ 30 D	

DCON MS tolerance h9.

Product	DC [mm]	LH [mm]	OAL [mm]	DCON MS [mm]	NOF
G1296.0	6.00	–	45.0	6.00	1
G1298.0	8.00	–	50.0	8.00	1
G12910.0	10.00	17.0	49.0	8.00	1
G12912.5	12.50	17.0	49.0	8.00	1
G12916.0	16.00	20.0	56.0	10.00	1
G12920.0	20.00	24.0	60.0	10.00	1
G12925.0	25.00	25.0	75.0	12.00	1
G12931.5	31.50	29.0	80.0	12.00	1



G149



HSS-E Straight Shank Cross-Hole 90° Countersink, Bright Finish

A 90° Countersink designed to chamfer holes and for removing burrs from drilled holes. The special cross-hole design directs chips away from the cutting edge to give a smooth chamfering operation. Suitable to chamfer holes in many materials.

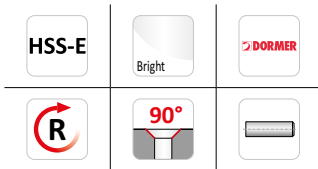
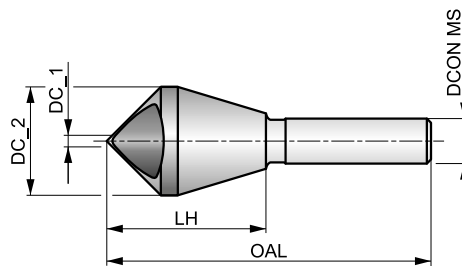

Workpiece material group suitability, starting values for cutting speed (m/min) and feed Alpha Code. Tables with feed per revolution can be found starting from page 251.

P1.1 ▣21 D	P1.2 ▣24 D	P1.3 ▣25 D	P2.1 ▣18 D	P2.2 ▣16 C	P2.3 ▣14 A	P3.1 ▣16 B	P3.2 ▣13 B	M1.1 ▣8 B	M1.2 ▣6 B	M2.1 ▣7 B	K1.1 ▣18 D	K2.1 ▣19 A	K3.1 ▣16 A
K5.1 ▣14 A	N1.1 ▣34 D	N1.2 ▣25 D	N1.3 ▣16 C	N2.1 ▣16 C	N2.2 ▣14 C	N3.1 ▣17 C	N3.2 ▣9 C	N3.3 ▣5 B	N4.1 ▣17 D	N4.2 ▣5 D			

Product	DC_2 [mm]	DC_1 [mm]	LH [mm]	OAL [mm]	DCON MS [mm]	DC [mm]	NOF
G1495	5.00	2.00	19.0	45.0	6.00	10.00	1
G14910	10.00	5.00	23.0	48.0	8.00	14.00	1
G14915	15.00	10.00	34.0	65.0	10.00	21.00	1
G14920	20.00	15.00	43.0	84.0	12.00	28.00	1
G14925	25.00	20.00	48.0	102.0	15.00	35.00	1
G14930	30.00	25.00	61.0	115.0	15.00	44.00	1
G14935	35.00	30.00	65.0	127.0	15.00	48.00	1
G14940	40.00	35.00	66.0	136.0	15.00	53.00	1
G14950	50.00	40.00	85.0	166.0	20.00	60.00	1



G136



HSS Straight Shank 90° Countersink, Bright Finish

A 90° Countersink designed to chamfer holes and for removing burrs from drilled holes. Reduced shank allows larger diameter countersinks in standard holders and chucks. Versatile tool, which can be used in hand-held and machine applications. Suitable to chamfer holes in many materials.

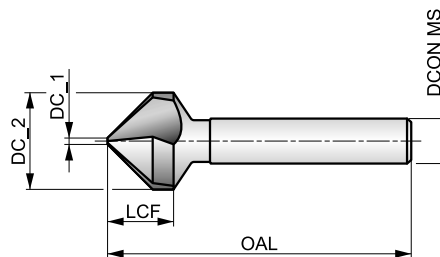

HSS	Bright	DIN 335C
R	90°	

Workpiece material group suitability, starting values for cutting speed (m/min) and feed Alpha Code. Tables with feed per revolution can be found starting from page 251.

P1.1 ■ 23 E	P1.2 ■ 26 E	P1.3 ■ 27 E	P2.1 ■ 20 E	P2.2 ■ 18 D	P2.3 ▣ 16 B	P3.1 ■ 16 D	P3.2 ■ 13 D	P3.3 ▣ 11 B	P4.1 ■ 10 D	P4.2 ▣ 8 B	M1.1 ▣ 8 C	M1.2 ▣ 6 C	M2.1 ▣ 7 C
M2.2 ▣ 16 C	K1.1 ▣ 20 F	K1.2 ▣ 15 D	K2.1 ▣ 21 C	K2.2 ▣ 17 C	K3.1 ▣ 18 C	K3.2 ▣ 14 C	K5.1 ▣ 19 C	K5.2 ▣ 15 C	N1.1 ▣ 40 G	N1.2 ■ 30 G	N1.3 ▣ 20 F	N2.1 ■ 20 F	N2.2 ▣ 18 F
N3.1 ■ 21 F	N3.2 ■ 12 F	N3.3 ▣ 6 D	N4.1 ▣ 40 G	N4.2 ▣ 35 G									

DCON MS tolerance h9.

Products from this series are also available in set. Please see G236.

Product	DC_2	DC_1	LCF	OAL	DCON MS	NOF
	[mm]	[mm]	[mm]	[mm]	[mm]	
G1364.3	4.30	1.30	4.0	40.0	4.00	3
G1365.0	5.00	1.50	4.5	40.0	4.00	3
G1365.3	5.30	1.50	4.5	40.0	4.00	3
G1365.8	5.80	1.50	5.0	45.0	5.00	3
G1366.0	6.00	1.50	5.0	45.0	5.00	3
G1366.3	6.30	1.50	5.5	45.0	5.00	3
G1367.0	7.00	1.80	5.5	50.0	6.00	3
G1367.3	7.30	1.80	6.1	50.0	6.00	3
G1368.0	8.00	2.00	6.1	50.0	6.00	3
G1368.3	8.30	2.00	6.5	50.0	6.00	3
G1369.4	9.40	2.20	7.2	50.0	6.00	3
G13610.0	10.00	2.50	7.6	50.0	6.00	3
G13610.4	10.40	2.50	7.6	50.0	6.00	3

Product	DC_2	DC_1	LCF	OAL	DCON MS	NOF
	[mm]	[mm]	[mm]	[mm]	[mm]	
G13611.5	11.50	2.80	8.0	56.0	8.00	3
G13612.4	12.40	2.80	8.5	56.0	8.00	3
G13613.4	13.40	2.90	9.0	56.0	8.00	3
G13615.0	15.00	3.20	9.5	60.0	10.00	3
G13616.5	16.50	3.20	10.5	60.0	10.00	3
G13619.0	19.00	3.50	11.7	63.0	10.00	3
G13620.5	20.50	3.50	13.0	63.0	10.00	3
G13623.0	23.00	3.80	13.7	67.0	10.00	3
G13625.0	25.00	3.80	15.5	67.0	10.00	3
G13626.0	26.00	3.80	15.5	67.0	10.00	3
G13628.0	28.00	4.00	16.5	71.0	12.00	3
G13630.0	30.00	4.20	18.5	71.0	12.00	3
G13631.0	31.00	4.20	18.5	71.0	12.00	3



G560



HSS Straight Shank 90° Countersink, TiAlN Coated

A 90° Countersink designed for chamfering standard fastener holes and removing burrs from drilled holes. Reduced shank allows larger diameter countersinks in standard holders and chucks. Versatile tool, which can be used in hand-held and machine applications. TiAlN coating improves performance and extends tool life.

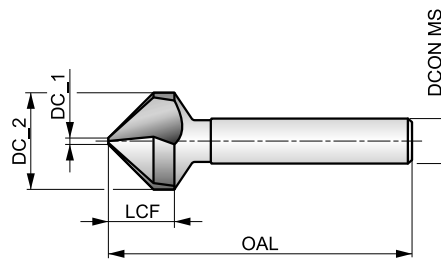

HSS	TiAlN	DIN 335C
R	90°	

Workpiece material group suitability, starting values for cutting speed (m/min) and feed Alpha Code. Tables with feed per revolution can be found starting from page 251.

P1.1 ■ 40 E	P1.2 ■ 45 E	P1.3 ■ 46 E	P2.1 ■ 34 E	P2.2 ■ 30 D	P2.3 ■ 27 B	P3.1 ■ 28 D	P3.2 ■ 22 D	P3.3 ■ 19 B	P4.1 ■ 16 D	P4.2 ■ 14 B	P4.3 ■ 11 B	M1.1 ■ 11 C	M1.2 ■ 9 C
M2.1 ■ 10 C	M2.2 ■ 9 C	M2.3 ■ 8 B	K1.1 ■ 41 F	K1.2 ■ 30 D	K1.3 ■ 23 D	K2.1 ■ 42 C	K2.2 ■ 34 C	K2.3 ■ 27 C	K3.1 ■ 37 C	K3.2 ■ 28 C	K3.3 ■ 23 C	K4.1 ■ 34 C	K4.2 ■ 26 C
K4.3 ■ 19 C	K5.1 ■ 39 C	K5.2 ■ 29 C	K5.3 ■ 23 C	N1.1 ■ 60 G	N1.2 ■ 45 G	N1.3 ■ 30 F	N2.1 ■ 30 F	N2.2 ■ 27 F	N2.3 ■ 19 F	N3.1 ■ 32 F	N3.2 ■ 18 F	N3.3 ■ 9 D	N4.1 ■ 62 G
N4.2 ■ 55 G													

DCON MS tolerance h9.

Products from this series are also available in set. Please see G236.

Product	DC_2	DC_1	LCF	OAL	DCON MS	NOF
	[mm]	[mm]	[mm]	[mm]	[mm]	
G5606.3	6.30	1.50	5.5	45.0	5.00	3
G5608.0	8.00	2.00	6.1	50.0	6.00	3
G5608.3	8.30	2.00	6.5	50.0	6.00	3
G56010.0	10.00	2.50	7.6	50.0	6.00	3
G56010.4	10.40	2.50	7.6	50.0	6.00	3
G56012.4	12.40	2.80	8.5	56.0	8.00	3
G56016.5	16.50	3.20	10.5	60.0	10.00	3
G56020.5	20.50	3.50	13.0	63.0	10.00	3
G56025.0	25.00	3.80	15.5	67.0	10.00	3
G56031.0	31.00	4.20	18.5	71.0	12.00	3



G106



HSS Tri-Flat Straight Shank 90° Countersink, Bright Finish

A 90° Countersink designed for chamfering standard fastener holes and removing burrs from drilled holes. Shank with three ground flats gives improved holding in three jaw chucks. Suitable to chamfer holes in many materials.

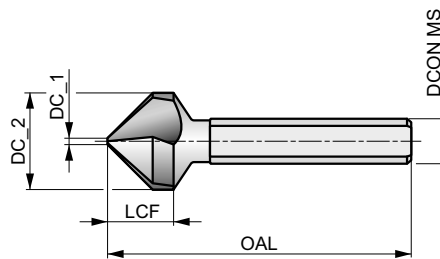

HSS	Bright	DIN 335C
R	90°	

Workpiece material group suitability, starting values for cutting speed (m/min) and feed Alpha Code. Tables with feed per revolution can be found starting from page 251.

P1.1 ■ 23 E	P1.2 ■ 26 E	P1.3 ■ 27 E	P2.1 ■ 20 E	P2.2 ■ 18 D	P2.3 ▣ 16 B	P3.1 ■ 16 D	P3.2 ■ 13 D	P3.3 ▣ 11 B	P4.1 ■ 10 D	P4.2 ▣ 8 B	M1.1 ▣ 8 C	M1.2 ▣ 6 C	M2.1 ▣ 7 C
M2.2 ▣ 6 C	K1.1 ■ 20 F	K1.2 ■ 15 D	K2.1 ▣ 21 C	K2.2 ▣ 17 C	K3.1 ▣ 18 C	K3.2 ▣ 14 C	K5.1 ▣ 19 C	K5.2 ▣ 15 C	N1.1 ▣ 40 G	N1.2 ■ 30 G	N1.3 ▣ 20 F	N2.1 ▣ 20 F	N2.2 ▣ 18 F
N3.1 ■ 21 F	N3.2 ▣ 12 F	N3.3 ▣ 6 D	N4.1 ▣ 40 G	N4.2 ▣ 35 G									

DCON MS tolerance h9.

Products from this series are also available in set. Please see G236.

Product	DC_2	DC_1	LCF	OAL	DCON MS	NOF
	[mm]	[mm]	[mm]	[mm]	[mm]	
G1066.3	6.30	1.50	5.6	45.0	5.00	3
G1068.3	8.30	2.00	6.9	50.0	6.00	3
G10610.4	10.40	2.50	7.8	50.0	6.00	3
G10612.4	12.40	2.80	8.6	56.0	8.00	3
G10616.5	16.50	3.20	11.1	60.0	10.00	3
G10620.5	20.50	3.50	12.9	63.0	10.00	3
G10625.0	25.00	3.80	15.7	67.0	10.00	3
G10631.0	31.00	4.20	18.5	71.0	12.00	3
G10634.0	34.00	4.50	19.0	103.0	16.00	3
G10637.0	37.00	4.50	21.2	118.0	16.00	3
G10640.0	40.00	4.50	20.0	118.0	16.00	3
G10650.0	50.00	5.00	23.6	126.0	16.00	3



G506



HSS Tri-Flat Straight Shank 90° Countersink, TiAlN Coated

A 90° Countersink designed for chamfering standard fastener holes and removing burrs from drilled holes. Shank with three ground flats gives improved holding in three jaw chucks, especially when using in hand-held power tools. TiAlN coating extends tool life. Suitable to chamfer holes in many materials.

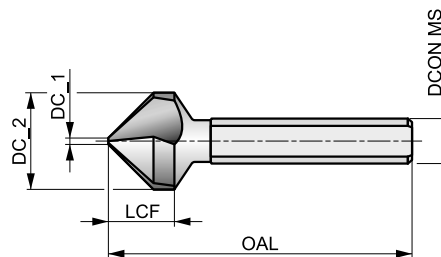

HSS	TiAlN	DIN 335C
R	90°	

Workpiece material group suitability, starting values for cutting speed (m/min) and feed Alpha Code. Tables with feed per revolution can be found starting from page 251.

P1.1 ■ 40 E	P1.2 ■ 45 E	P1.3 ■ 46 E	P2.1 ■ 34 E	P2.2 ■ 30 D	P2.3 ■ 27 B	P3.1 ■ 28 D	P3.2 ■ 22 D	P3.3 ■ 19 B	P4.1 ■ 16 D	P4.2 ■ 14 B	P4.3 ▣ 11 B	M1.1 ▣ 11 C	M1.2 ▣ 9 C
M2.1 ▣ 10 C	M2.2 ▣ 9 C	M2.3 ▣ 8 B	K1.1 ■ 41 F	K1.2 ■ 30 D	K1.3 ▣ 23 D	K2.1 ■ 42 C	K2.2 ■ 34 C	K2.3 ▣ 27 C	K3.1 ■ 37 C	K3.2 ■ 28 C	K3.3 ▣ 23 C	K4.1 ▣ 34 C	K4.2 ▣ 26 C
K4.3 ▣ 19 C	K5.1 ■ 39 C	K5.2 ■ 29 C	K5.3 ▣ 23 C	N1.1 ▣ 60 G	N1.2 ▣ 45 G	N1.3 ■ 30 F	N2.1 ■ 30 F	N2.2 ■ 27 F	N2.3 ■ 19 F	N3.1 ■ 32 F	N3.2 ■ 18 F	N3.3 ▣ 19 D	N4.1 ▣ 62 G
N4.2 ▣ 55 G													

DCON MS tolerance h9.

Products from this series are also available in set. Please see G236.

Product	DC_2	DC_1	LCF	OAL	DCON MS	NOF
	[mm]	[mm]	[mm]	[mm]	[mm]	
G5066.3	6.30	1.50	5.6	45.0	5.00	3
G5068.3	8.30	2.00	6.9	50.0	6.00	3
G50610.4	10.40	2.50	7.8	50.0	6.00	3
G50612.4	12.40	2.80	8.6	56.0	8.00	3
G50616.5	16.50	3.20	11.1	60.0	10.00	3
G50620.5	20.50	3.50	12.9	63.0	10.00	3
G50625.0	25.00	3.80	15.7	67.0	10.00	3
G50631.0	31.00	4.20	18.5	71.0	12.00	3
G50634.0	34.00	4.50	19.0	103.0	16.00	3
G50637.0	37.00	4.50	21.2	118.0	16.00	3
G50640.0	40.00	4.50	20.0	118.0	16.00	3
G50650.0	50.00	5.00	23.6	126.0	16.00	3



G142



HSS Straight Shank, 90° Countersink, Bright Finish, for Stainless Steel

A 90° Countersink designed for chamfering holes for standard fasteners and to clean burrs from drilled holes. Increased relief to provide a sharper edge, which improves performance when machining sticky materials, such as stainless steels and non-ferrous materials. Can be used in hand-held and machine applications.

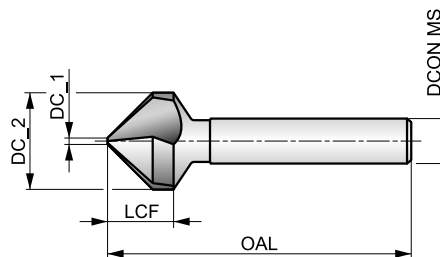

HSS	Bright	DIN 335C
R	90°	

Workpiece material group suitability, starting values for cutting speed (m/min) and feed Alpha Code. Tables with feed per revolution can be found starting from page 251.

P1.1 ■ 23 E	P1.2 ■ 26 E	P1.3 ■ 27 E	P2.1 ■ 20 E	P2.2 ■ 18 D	P2.3 ▣ 16 B	P3.1 ■ 16 D	P3.2 ■ 13 D	P3.3 ▣ 11 B	P4.1 ■ 10 D	P4.2 ▣ 8 B	M1.1 ■ 11 C	M1.2 ■ 9 C	M2.1 ■ 10 C
M2.2 ▣ 8 C	M3.1 ■ 7 B	M3.2 ▣ 6 B	M4.1 ▣ 4 A	N1.1 ■ 40 G	N1.2 ■ 30 G	N1.3 ▣ 20 F	N2.1 ▣ 20 F	N2.2 ▣ 18 F	N2.3 ▣ 20 F	N3.1 ■ 34 F	N3.2 ■ 20 F	N3.3 ■ 10 D	N4.1 ■ 40 G
N4.2 ■ 35 G													

DCON MS tolerance h9.

Product	DC_2 [mm]	DC_1 [mm]	LCF [mm]	OAL [mm]	DCON MS [mm]	NOF
G1424.8	4.80	1.30	4.5	40.0	4.00	3
G1425.0	5.00	1.50	4.5	40.0	4.00	3
G1426.0	6.00	1.50	5.0	45.0	5.00	3
G1426.3	6.30	1.50	5.5	45.0	5.00	3
G1427.0	7.00	1.80	5.5	50.0	6.00	3
G1427.3	7.30	1.80	6.1	50.0	6.00	3
G1428.0	8.00	2.00	6.1	50.0	6.00	3
G1428.3	8.30	2.00	6.5	50.0	6.00	3
G14210.0	10.00	2.50	7.6	50.0	6.00	3
G14210.4	10.40	2.50	7.6	50.0	6.00	3
G14211.5	11.50	2.80	8.0	56.0	8.00	3
G14212.4	12.40	2.80	8.5	56.0	8.00	3
G14215.0	15.00	3.20	9.5	60.0	10.00	3
G14216.5	16.50	3.20	10.5	60.0	10.00	3
G14219.0	19.00	3.50	11.7	63.0	10.00	3
G14220.5	20.50	3.50	13.0	63.0	10.00	3
G14223.0	23.00	3.80	13.7	67.0	10.00	3
G14225.0	25.00	3.80	15.5	67.0	10.00	3
G14231.0	31.00	4.20	18.5	71.0	12.00	3



G570



HSS-E Straight Shank 90° Countersink, AlTiCN Coated

A 90° Countersink designed for chamfering holes to accommodate standard fasteners and clean burrs from drilled holes. Can be used in machine and hand-held applications. Particularly suited to chamfering holes in hard and abrasive materials. AlTiCN coating improves performance and extends tool life.

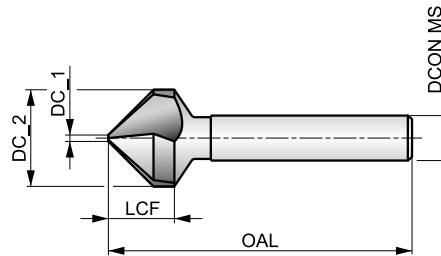

HSS-E	AlTiCN	DIN 335C
R	90°	

Workpiece material group suitability, starting values for cutting speed (m/min) and feed Alpha Code. Tables with feed per revolution can be found starting from page 251.

P1.1 ▣40 E	P1.2 ▣45 E	P1.3 ▣46 E	P2.1 ▣34 E	P2.2 ▣30 D	P2.3 ▣27 B	P3.1 ▣28 D	P3.2 ▣22 D	P3.3 ▣19 B	P4.1 ▣16 D	P4.2 ▣14 B	P4.3 ▣11 B	M1.1 ▣23 C	M1.2 ▣20 C
M2.1 ▣21 C	M2.2 ▣17 C	M2.3 ▣14 A	M3.1 ▣14 B	M3.2 ▣12 B	M3.3 ▣11 B	M4.1 ▣15 A	M4.2 ▣13 A	K1.1 ▣41 C	K1.2 ▣30 C	K1.3 ▣23 C	K2.1 ▣42 C	K2.2 ▣34 C	K2.3 ▣27 C
K3.1 ▣37 C	K3.2 ▣28 C	K3.3 ▣23 C	K4.1 ▣34 C	K4.2 ▣26 C	K4.3 ▣19 C	K5.1 ▣39 C	K5.2 ▣29 C	K5.3 ▣23 C	N1.1 ▣60 G	N1.2 ▣45 G	N1.3 ▣30 F	N2.1 ▣30 F	N2.2 ▣27 F
N2.3 ▣19 F	N3.1 ▣32 F	N3.2 ▣18 F	N3.3 ▣9 D										

DCON MS tolerance h9.

Product	DC_2 [mm]	DC_1 [mm]	LCF [mm]	OAL [mm]	DCON MS [mm]	NOF
G5706.3	6.30	1.50	6.5	45.0	5.00	3
G5708.3	8.30	2.00	8.2	50.0	6.00	3
G57010.4	10.40	2.50	9.7	50.0	6.00	3
G57012.4	12.40	2.80	10.6	56.0	8.00	3
G57016.5	16.50	3.20	13.9	60.0	10.00	3
G57020.5	20.50	3.50	17.1	63.0	10.00	3
G57025.0	25.00	3.80	21.4	67.0	10.00	3
G57031.0	31.00	4.20	24.4	71.0	12.00	3



G107



HSS-E Hexagon Drive 90° Countersink, Bright Finish

A versatile countersink with a hexagonal shank which makes it easier to hold with electric screwdriver adaptors. The 90° countersink produces chamfers for standard fasteners and clean burrs from drilled holes. Suitable to chamfer holes in many materials.

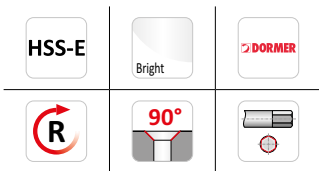
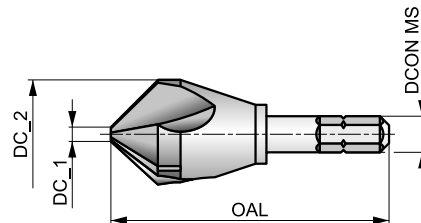

Workpiece material group suitability, starting values for cutting speed (m/min) and feed Alpha Code. Tables with feed per revolution can be found starting from page 251.

P1.1 ■ 23 E	P1.2 ■ 26 E	P1.3 ■ 27 E	P2.1 ■ 20 E	P2.2 ■ 18 D	P2.3 ▣ 16 B	P3.1 ■ 16 D	P3.2 ■ 13 D	P3.3 ▣ 11 B	P4.1 ■ 10 D	P4.2 ▣ 8 B	M1.1 ▣ 11 C	M1.2 ▣ 9 C	M2.1 ▣ 10 C
M2.2 ▣ 9 C	M2.3 ▣ 8 B	K1.1 ■ 20 F	K1.2 ▣ 15 D	K2.1 ■ 21 C	K2.2 ▣ 17 C	K3.1 ■ 18 C	K3.2 ▣ 14 C	K4.1 ▣ 15 C	K5.1 ■ 19 C	K5.2 ▣ 15 C	N1.1 ▣ 40 G	N1.2 ■ 30 G	N1.3 ▣ 20 F
N2.1 ▣ 20 F	N2.2 ▣ 18 F	N2.3 ▣ 20 F	N3.1 ■ 21 F	N3.2 ▣ 12 F	N3.3 ▣ 6 D	N4.1 ▣ 40 G	N4.2 ▣ 35 G						

6.35; 1/4" hex shank; DIN 74.

Product	DC_2	DC_1	OAL	DCONMS	CZC MS	NOF
	[mm]	[mm]	[mm]	[inch]		
G1076.3	6.30	1.50	50.0	1/4"	M2-M3	3
G1078.3	8.30	2.00	50.0	1/4"	M4	3
G10710.4	10.40	2.50	50.0	1/4"	M5	3
G10712.4	12.40	2.80	50.0	1/4"	M6	3
G10716.5	16.50	3.20	50.0	1/4"	M8	3
G10720.5	20.50	3.50	50.0	1/4"	M10	3



G600



HSS Straight Shank Long Reach 90° Countersink, Bright Finish

The extended shank gives the ability to chamfer holes in areas which are difficult to reach. The 90° countersink produces chamfers for standard fasteners and clean burrs from drilled holes. Suitable to chamfer holes in many materials.

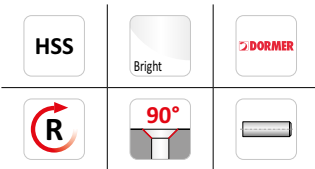

Workpiece material group suitability, starting values for cutting speed (m/min) and feed Alpha Code. Tables with feed per revolution can be found starting from page 251.

P1.1 ■ 20 E	P1.2 ■ 22 E	P1.3 ■ 23 E	P2.1 ■ 17 E	P2.2 ■ 15 D	P2.3 ■ 13 B	P3.1 ■ 12 D	P3.2 ■ 9 D	P3.3 ■ 8 B	P4.1 ■ 7 D	P4.2 ■ 6 B	M1.1 ■ 8 C	M1.2 ■ 6 C	M2.1 ■ 7 C
M2.2 ■ 16 C	K1.1 ■ 17 E	K1.2 ■ 12 C	K2.1 ■ 18 B	K2.2 ■ 14 B	K3.1 ■ 15 B	K3.2 ■ 11 B	K5.1 ■ 16 B	K5.2 ■ 12 B	N1.1 ■ 35 G	N1.2 ■ 25 G	N1.3 ■ 15 F	N2.1 ■ 15 F	N2.2 ■ 13 F
N3.1 ■ 16 E	N3.2 ■ 10 E	N3.3 ■ 5 C											

DCON MS tolerance h9.

Product	DC_2 [mm]	DC_1 [mm]	LCF [mm]	OAL [mm]	DCON MS [mm]	NOF
G6006.3	6.30	1.30	5.6	154.0	5.00	3
G6008.3	8.30	1.80	6.9	155.0	6.00	3
G60010.4	10.40	2.20	7.8	157.0	6.00	3
G60012.4	12.40	2.50	8.6	158.0	8.00	3
G60015.0	15.00	2.80	10.3	159.0	10.00	3
G60016.5	16.50	2.80	11.1	161.0	10.00	3
G60020.5	20.50	3.00	12.9	164.0	10.00	3
G60025.0	25.00	3.20	15.7	168.0	10.00	3



G132



HSS Straight Shank Multi-Flute 90° Countersink, Bright Finish

A 90° Countersink designed for chamfering holes to accommodate standard fasteners and clean burrs from drilled holes. Multiple flutes to reduce chatter and vibration, giving a smooth chamfering operation. Versatile tool for use in hand-held and machine applications. Suitable to chamfer holes in many materials.

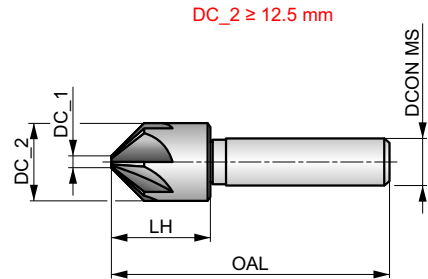
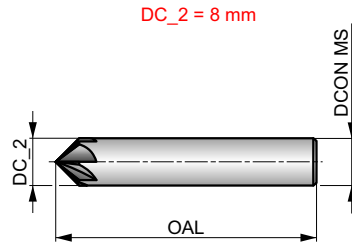

HSS	Bright	DIN 335A
R	90°	

Workpiece material group suitability, starting values for cutting speed (m/min) and feed Alpha Code. Tables with feed per revolution can be found starting from page 251.

P2.2 ▣ 18 E	P2.3 ▣ 16 D	P3.2 ▣ 13 D	P3.3 ▣ 11 B	P4.1 ▣ 10 D	P4.2 ▣ 8 C	P4.3 ▣ 7 B	M3.3 ▣ 3 A	M4.1 ▣ 4 A	K1.1 ▣ 20 F	K1.2 ▣ 15 D	K1.3 ▣ 11 D	K2.2 ▣ 17 C	K2.3 ▣ 14 D
K3.1 ▣ 18 E	K3.2 ▣ 14 E	K3.3 ▣ 11 D	K4.1 ▣ 17 C	K4.2 ▣ 13 C	K5.1 ▣ 19	K5.2 ▣ 15	K5.3 ▣ 11 D	N1.3 ▣ 20 F	N2.3 ▣ 13 F	N3.2 ▣ 12 F	N4.3 ▣ 5 G		

DCON MS tolerance h9.

Product	DC_2 [mm]	DC_1 [mm]	LH [mm]	OAL [mm]	DCON MS [mm]	NOF
G1328.0	8.00	—	—	48.0	8.00	5
G13212.5	12.50	2.00	15.5	48.0	8.00	5
G13216.0	16.00	3.20	19.5	56.0	10.00	7
G13220.0	20.00	5.00	23.0	60.0	10.00	7



G138



HSS Taper Shank 90° Countersink, Bright Finish

A 90° Countersink designed for chamfering standard fastener holes and removing burrs from drilled holes. Taper shank design allows the tool to be used in machine applications where it is held directly in the spindle. Suitable to chamfer holes in many materials.

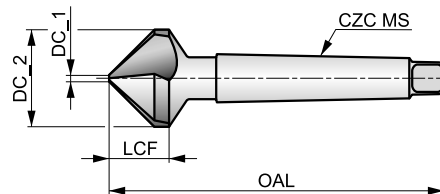

HSS	Bright	DIN 335D
R	90°	

Workpiece material group suitability, starting values for cutting speed (m/min) and feed Alpha Code. Tables with feed per revolution can be found starting from page 251.

P1.1 ■ 23 E	P1.2 ■ 26 E	P1.3 ■ 27 E	P2.1 ■ 20 E	P2.2 ■ 18 D	P2.3 ▧ 16 B	P3.1 ■ 16 D	P3.2 ▧ 13 D	P3.3 ▧ 11 B	P4.1 ■ 10 D	P4.2 ▧ 8 B	M1.1 ▧ 8	M1.2 ▧ 6	M2.1 ▧ 7
M2.2 ▧ 6	K1.1 ▧ 20 F	K1.2 ▧ 15 D	K2.1 ▧ 21 C	K2.2 ▧ 17 C	K3.1 ▧ 18 C	K3.2 ▧ 14 C	K5.1 ▧ 19 C	K5.2 ▧ 15 C	N1.1 ▧ 40 G	N1.2 ■ 30 G	N1.3 ▧ 20 F	N2.1 ■ 20 F	N2.2 ▧ 18 F
N3.1 ■ 21 F	N3.2 ■ 12 F	N3.3 ▧ 6 D	N4.1 ▧ 40 G	N4.2 ▧ 35 G									

Product	DC_2 [mm]	DC_1 [mm]	LCF [mm]	OAL [mm]	CZC MS	NOF
G13825.0	25.00	3.80	15.5	106.0	MK 2	3
G13830.0	30.00	4.20	18.5	112.0	MK 2	3
G13831.0	31.00	4.20	20.0	112.0	MK 2	3
G13834.0	34.00	4.50	19.5	118.0	MK 2	3
G13837.0	37.00	4.80	21.7	118.0	MK 2	3
G13840.0	40.00	10.00	20.5	140.0	MK 3	3
G13850.0	50.00	14.00	24.1	150.0	MK 3	3
G13863.0	63.00	16.00	28.5	180.0	MK 4	3
G13880.0	80.00	22.00	36.0	190.0	MK 4	3



G338



HSS Taper Shank 90° Countersink, TiN Coated

A 90° Countersink designed for chamfering standard fastener holes and removing burrs. Improved performance when machining for long periods at high speed. Taper shank design allows it to be held directly in the spindle. TiN Coating improves performance and extends tool life. Suitable for many materials.

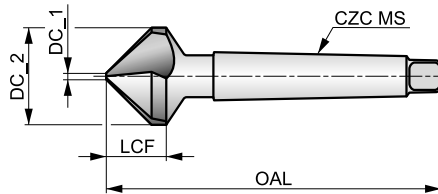

HSS	TiN	DIN 335D
R	90°	

Workpiece material group suitability, starting values for cutting speed (m/min) and feed Alpha Code. Tables with feed per revolution can be found starting from page 251.

P1.1 ■ 33 E	P1.2 ■ 37 E	P1.3 ■ 38 E	P2.1 ■ 28 E	P2.2 ■ 25 D	P2.3 ■ 22 B	P3.1 ■ 23 D	P3.2 ■ 18 D	P3.3 ■ 15 B	P4.1 ■ 13 D	P4.2 ■ 11 B	P4.3 ▣ 9 B	M1.1 ▣ 11 C	M1.2 ▣ 9 C
M2.1 ▣ 10 C	M2.2 ▣ 9 C	M2.3 ▣ 8 B	K1.1 ■ 34 F	K1.2 ■ 25 D	K1.3 ▣ 19 D	K2.1 ■ 35 C	K2.2 ■ 28 C	K2.3 ▣ 23 C	K3.1 ■ 31 C	K3.2 ■ 24 C	K3.3 ▣ 19 C	K4.1 ▣ 29 C	K4.2 ▣ 22 C
K4.3 ▣ 16 C	K5.1 ■ 32 C	K5.2 ■ 24 C	K5.3 ▣ 19 C	N1.1 ■ 53 G	N1.2 ■ 40 G	N1.3 ■ 27 F	N2.1 ■ 27 F	N2.2 ■ 24 F	N2.3 ■ 17 F	N3.1 ■ 28 F	N3.2 ■ 16 F	N3.3 ▣ 8 D	N4.1 ▣ 58 G
N4.2 ▣ 50 G													

Product	DC_2 [mm]	DC_1 [mm]	LCF [mm]	OAL [mm]	CZC MS	NOF
G33825.0	25.00	3.80	15.5	106.0	MK 2	3
G33831.0	31.00	4.20	20.0	112.0	MK 2	3
G33837.0	37.00	4.80	21.7	118.0	MK 2	3
G33840.0	40.00	10.00	20.5	140.0	MK 3	3
G33850.0	50.00	14.00	24.1	150.0	MK 3	3
G33863.0	63.00	16.00	28.5	180.0	MK 4	3



G171



HSS Straight Shank 100° Countersink, TiAIN Coated

A 100° Countersink designed for chamfering standard fastener holes and removing burrs. A versatile tool with a TiAIN coating which improves performance and extends tool life. Versatile tool that can be used in both hand-held and machine applications. Suitable to chamfer holes in many materials.

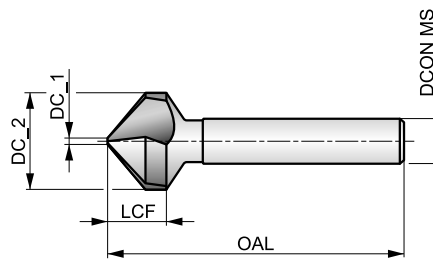

HSS	TiAIN	DIN 335C
R	100°	

Workpiece material group suitability, starting values for cutting speed (m/min) and feed Alpha Code. Tables with feed per revolution can be found starting from page 251.

P1.1 ■ 40 E	P1.2 ■ 45 E	P1.3 ■ 46 E	P2.1 ■ 34 E	P2.2 ■ 30 D	P2.3 ■ 27 B	P3.1 ■ 28 D	P3.2 ■ 22 D	P3.3 ■ 19 B	P4.1 ■ 16 D	P4.2 ■ 14 B	P4.3 ▧11 B	M1.1 ▧11 C	M1.2 ▧19 C
M2.1 ▧10 C	K1.1 ■ 41 F	K1.2 ■ 30 D	K1.3 ▧23 D	K2.1 ■ 42 C	K2.2 ■ 34 C	K2.3 ▧27 C	K3.1 ■ 37 C	K3.2 ■ 28 C	K3.3 ▧23 C	K4.1 ▧34 C	K4.2 ▧26 C	K4.3 ▧19 C	K5.1 ■ 39 C
K5.2 ■ 29 C	K5.3 ▧23 C	N1.1 ▧60 G	N1.2 ▧45 G	N1.3 ■ 30 F	N2.1 ■ 30 F	N2.2 ■ 27 F	N2.3 ■ 19 F	N3.1 ■ 32 F	N3.2 ■ 18 F	N3.3 ▧19 D	N4.1 ▧62 G	N4.2 ▧55 G	

DCON MS tolerance h9.

Product	DC_2 [mm]	DC_1 [mm]	LCF [mm]	OAL [mm]	DCON MS [mm]	NOF
G1716.3	6.30	1.50	4.5	44.0	5.00	3
G1718.3	8.30	2.00	5.5	49.0	6.00	3
G17110.4	10.40	2.50	6.6	49.0	6.00	3
G17112.4	12.40	2.80	7.0	53.0	8.00	3
G17116.5	16.50	3.20	9.0	56.0	10.00	3
G17120.5	20.50	3.50	11.0	61.0	10.00	3
G17125.0	25.00	3.80	13.5	65.0	10.00	3



G314



HSS Cone Cut Step Drill for Thin Sheet Materials, Bright Finish

Cone cut step drills have a multi-step design which allows for gradual enlargement of holes to the diameter required. The reduced plain shank means all diameters can be held in a standard chuck and holder. Suitable to enlarge holes in many materials.

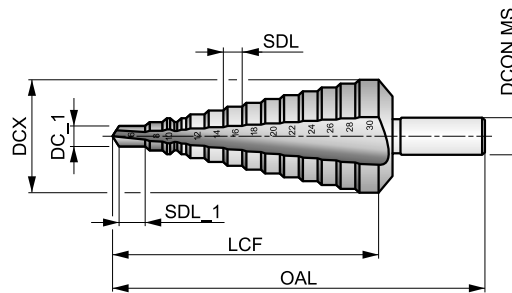

HSS	Bright	DORMER
R	20°	

Workpiece material group suitability, starting values for cutting speed (m/min) and feed Alpha Code. Tables with feed per revolution can be found starting from page 251.

P1.1 ■ 20	P1.2 ■ 22	P1.3 ■ 23	P2.1 ■ 17	P2.2 ■ 15	P2.3 ■ 13	P3.1 ■ 12	P3.2 ■ 9	M1.1 ■ 8	M1.2 ■ 6	M2.1 ■ 7	K1.1 ■ 17	N1.1 ■ 30	N1.2 ■ 23
N1.3 ■ 15	N2.1 ■ 31	N2.2 ■ 28	N3.1 ■ 34	N3.2 ■ 20	N3.3 ■ 10	N4.1 ■ 30	N4.2 ■ 20						

SDI = Step diameter increments.

Product	Nr.	DC_1	DCX	SDL	SDI	SDL_1	LCF	OAL	DCON MS
		[mm]	[mm]	[mm]	[mm]	[mm]	[mm]	[mm]	[mm]
G314412	412	4.00	12.00	5.00	4 - 5 - 6 - 7 - 8 - 9 - 10 - 11 - 12	5.00	61.0	80.0	6.00
G3141220	1220	12.00	20.00	4.00	12 - 13 - 14 - 15 - 16 - 17 - 18 - 19 - 20	4.00	55.0	76.0	9.00
G3142030	2030	20.00	30.00	4.00	20 - 21 - 22 - 23 - 24 - 25 - 26 - 27 - 28 - 29 - 30	4.00	67.0	88.0	12.00
G3143040	3040	30.00	40.00	4.00	30 - 31 - 32 - 33 - 34 - 35 - 36 - 37 - 38 - 39 - 40	4.00	74.0	98.0	13.00
G314420	420	4.00	20.00	4.00	4 - 6 - 8 - 10 - 12 - 14 - 16 - 18 - 20	4.00	48.0	76.0	8.00
G314630	630	6.00	30.00	4.00	6 - 8 - 10 - 12 - 14 - 16 - 18 - 20 - 22 - 24 - 26 - 28 - 30	4.00	73.0	98.0	10.00
G314M	M	9.00	36.00	3.00	9 - 12 - 15 - 18 - 21 - 24 - 27 - 30 - 33 - 36	3.00	57.0	86.0	12.00



G125



HSS Straight Shank 180° Counterbore, Bright Finish

Counterbore with a 180° angle designed to create holes for standard socket head and cap screws. It has a solid Pilot (available for different pre-machined hole size tolerances), which helps to accurately guide the counterbore in standard metric sized holes. Suitable to counterbore holes in many materials.

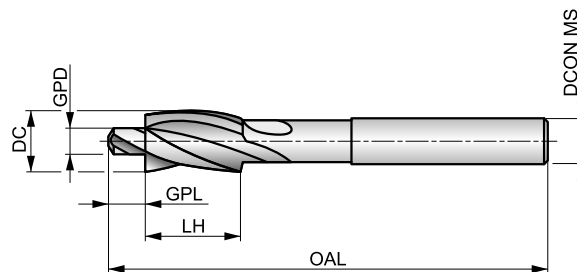

HSS	Bright	DIN 373
R	180°	

Workpiece material group suitability, starting values for cutting speed (m/min) and feed Alpha Code. Tables with feed per revolution can be found starting from page 251.

P1.1 ■ 20 E	P1.2 ■ 22 E	P1.3 ■ 23 E	P2.1 ■ 17 E	P2.2 ■ 15 D	P2.3 ■ 13 C	P3.1 ■ 12 D	P3.2 ■ 9 D	P3.3 ■ 8 C	P4.1 ■ 7 D	P4.2 ■ 6 C	M1.1 ■ 8 D	M1.2 ■ 6 D	M2.1 ■ 7 D
M2.2 ■ 6 D	M2.3 ■ 5 C	K1.1 ■ 17 E	K1.2 ■ 12 E	K1.3 ■ 11 E	K2.1 ■ 15 D	K2.2 ■ 12 D	K2.3 ■ 10 C	K3.1 ■ 13 D	K3.2 ■ 10 D	K4.1 ■ 12 D	K4.2 ■ 9 D	K5.1 ■ 14 D	K5.2 ■ 10 D
N1.1 ■ 30 G	N1.2 ■ 23 G	N1.3 ■ 15 G	N2.1 ■ 31 G	N2.2 ■ 28 G	N2.3 ■ 20 G	N3.1 ■ 34 C	N3.2 ■ 20 C	N3.3 ■ 10 C	N4.1 ■ 30 C	N4.2 ■ 20 C			

DCON MS tolerance h9.

Product	DC	GPD	CZC MS	GPL	OAL	LH	DCON MS	NOF
	[mm]	[mm]		[mm]	[mm]	[mm]	[mm]	
G1256.5X2.5 ³⁾	6.50	2.50	M 3 t	4.50	71.0	14.0	5.00	3
G1256.5X3.2 ¹⁾	6.50	3.20	M 3 f	4.50	71.0	14.0	5.00	3
G1256.5X3.4 ²⁾	6.50	3.40	M 3 m	4.50	71.0	14.0	5.00	3
G1258.0X3.3 ³⁾	8.00	3.30	M 4 t	5.00	71.0	14.0	5.00	3
G1258.0X4.3 ¹⁾	8.00	4.30	M 4 f	5.00	71.0	14.0	5.00	3
G1258.0X4.5 ²⁾	8.00	4.50	M 4 m	5.00	71.0	14.0	5.00	3
G12510.0X4.2 ³⁾	10.00	4.20	M 5 t	5.50	80.0	18.0	8.00	3
G12510.0X5.3 ¹⁾	10.00	5.30	M 5 f	5.50	80.0	18.0	8.00	3
G12510.0X5.5 ²⁾	10.00	5.50	M 5 m	5.50	80.0	18.0	8.00	3
G12511.0X5.0 ³⁾	11.00	5.00	M 6 t	6.00	80.0	18.0	8.00	3
G12511.0X6.4 ¹⁾	11.00	6.40	M 6 f	6.00	80.0	18.0	8.00	3
G12511.0X6.6 ²⁾	11.00	6.60	M 6 m	6.00	80.0	18.0	8.00	3
G12515.0X6.8 ³⁾	15.00	6.80	M 8 t	8.00	100.0	22.0	12.50	3
G12515.0X8.4 ¹⁾	15.00	8.40	M 8 f	8.00	100.0	22.0	12.50	3
G12515.0X9.0 ²⁾	15.00	9.00	M 8 m	8.00	100.0	22.0	12.50	3
G12518.0X8.5 ³⁾	18.00	8.50	M 10 t	10.00	100.0	22.0	12.50	3
G12518.0X10.5 ¹⁾	18.00	10.50	M 10 f	10.00	100.0	22.0	12.50	3
G12518.0X11.0 ²⁾	18.00	11.00	M 10 m	10.00	100.0	22.0	12.50	3
G12520.0X10.2 ³⁾	20.00	10.20	M 12 t	10.00	100.0	22.0	12.50	3
G12520.0X13.0 ¹⁾	20.00	13.00	M 12 f	10.00	100.0	22.0	12.50	3
G12520.0X13.5 ²⁾	20.00	13.50	M 12 m	10.00	100.0	22.0	12.50	3

¹⁾ f= for through hole fine.

²⁾ m= for through hole medium.

³⁾ t= for tap hole.



G236



Sets of Countersink in a Cylindrical Plastic Drum

Sets containing a variety of sizes of different 90° countersinks. There are 5 different sets filled either with G106, G136 or G560 available. Suitable for many materials.

A=Styles in Set, B=No. in Set, C=Diameters in Set.

Product	Nr.	A	B	C
G2361	1	G136	6	6.30 mm, 8.30 mm, 10.40 mm, 12.40 mm, 16.50 mm, 20.50 mm
G2362	2	G136	4	6.30 mm, 10.40 mm, 16.50 mm, 20.50 mm
G2363	3	G560	6	6.30 mm, 8.30 mm, 10.40 mm, 12.40 mm, 16.50 mm, 20.50 mm
G2364	4	G106	6	6.30 mm, 8.30 mm, 10.40 mm, 12.40 mm, 16.50 mm, 20.50 mm
G2365	5	G506	6	6.30 mm, 8.30 mm, 10.40 mm, 12.40 mm, 16.50 mm, 20.50 mm



REAMERS FEED RATE CHART

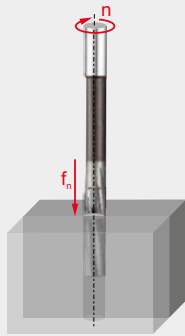

Feed per revolution (f_n in mm/rev)
Depending on the working conditions
it might be necessary to adjust these
values $\pm 15\%$.

How to use this table to find the feed per revolution (f_n):

1. Find your Alpha Code on the product page (example: 21C, "C" is the Alpha Code).
2. Find the closest diameter for your cutting application in the top row of the table.
3. Find your Alpha Code in the left column of the table.
4. The intersection (cell) of the Diameter and Alpha Code is the feed per revolution (f_n).

		\varnothing DC [mm]																		
		1.00	1.50	2.00	3.00	4.00	5.00	6.00	7.00	8.00	10.00	12.00	15.00	16.00	20.00	25.00	30.00	40.00	50.00	80.00
Feed rates	A	0.030	0.045	0.055	0.078	0.090	0.100	0.125	0.137	0.150	0.170	0.185	0.210	0.220	0.250	0.280	0.320	0.390	0.440	0.500
	B	0.035	0.055	0.072	0.110	0.130	0.150	0.165	0.172	0.180	0.210	0.240	0.270	0.280	0.310	0.360	0.400	0.500	0.550	0.600
	C	0.040	0.065	0.085	0.135	0.160	0.185	0.200	0.210	0.220	0.260	0.285	0.325	0.335	0.390	0.440	0.480	0.600	0.680	0.750
	D	0.050	0.080	0.110	0.160	0.180	0.200	0.235	0.253	0.270	0.320	0.360	0.400	0.410	0.470	0.540	0.600	0.730	0.850	0.950
	E	0.065	0.100	0.140	0.180	0.215	0.250	0.300	0.325	0.350	0.390	0.430	0.485	0.500	0.530	0.640	0.750	0.910	1.100	1.200
	F	0.090	0.140	0.180	0.260	0.305	0.350	0.395	0.417	0.440	0.500	0.550	0.610	0.630	0.700	0.800	0.930	1.200	1.500	1.650

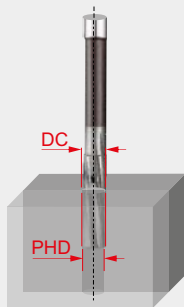

Machining allowance when using
a **machine reamer** (MA in mm)
Premachined hole diameter
 $PHD = DC - MA$.

How to use this table to get to the right premachined hole diameter (PHD):

1. Find the diameter range for your cutting application in the top row of the table.
2. Find your ISO Group Code in the left column of the table (example: For Stainless Steel the ISO Group Code is "M")
3. The intersection (cell) of the Diameter Range and ISO Group Code is the Machining Allowance (MA)
4. Subtract the Machining Allowance from the reaming diameter to get to the premachined hole diameter (PHD).

(example: for a 6mm hole in steel (P) the PHD is 5.85mm)

		\varnothing DC [mm]															
		1.00	5.00	5.00	8.00	8.00	12.00	12.00	16.00	16.00	30.00	30.00	80.00				
ISO group	P	0.10			0.15			0.20			0.20			0.30			0.30
	M	0.08			0.10			0.10			0.20			0.20			0.30
	K	0.10			0.15			0.20			0.20			0.30			0.30
	N	0.10			0.15			0.20			0.20			0.30			0.30
	S	0.05			0.10			0.10			0.15			0.20			0.20
	H	0.05			0.05			0.10			0.10			0.15			0.20

Be cautious with the machining tolerances of drills, the tool diameter is not the same as the hole diameter produced!

Note: The recommended allowance when using a hand reamer is 0.05 to 0.10 mm.



COUNTERSINKS FEED RATE CHART

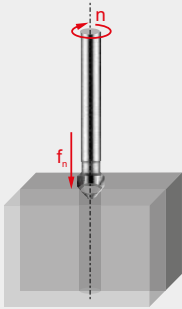

Feed per revolution (f_n in mm/rev)
Depending on the working conditions
it might be necessary to adjust these
values $\pm 15\%$.

How to use this table to find the feed per revolution (f_n):

1. Find your Alpha Code on the product page (example: 23E, "E" is the Alpha Code).
2. Find the closest diameter for your cutting application in the top row of the table.
3. Find your Alpha Code in the left column of the table.
4. The intersection (cell) of the Diameter and Alpha Code is the feed per revolution (f_n).

		$\varnothing DC$ [mm]									
		6.00	8.00	10.00	16.00	20.00	25.00	32.00	40.00	60.00	80.00
Feed rates	A	0.030	0.040	0.050	0.060	0.080	0.090	0.100	0.120	0.140	0.160
	B	0.040	0.050	0.060	0.080	0.100	0.120	0.140	0.160	0.180	0.200
	C	0.050	0.060	0.080	0.100	0.120	0.140	0.160	0.180	0.200	0.220
	D	0.060	0.080	0.100	0.120	0.150	0.180	0.200	0.220	0.250	0.280
	E	0.080	0.100	0.120	0.150	0.180	0.200	0.250	0.270	0.300	0.320
	F	0.090	0.110	0.130	0.160	0.190	0.210	0.260	0.290	0.330	0.360
	G	0.100	0.120	0.150	0.180	0.200	0.220	0.280	0.320	0.360	0.400
	H	0.120	0.150	0.180	0.200	0.220	0.250	0.300	0.350	0.400	0.450

Reamer Definitions / Nomenclature

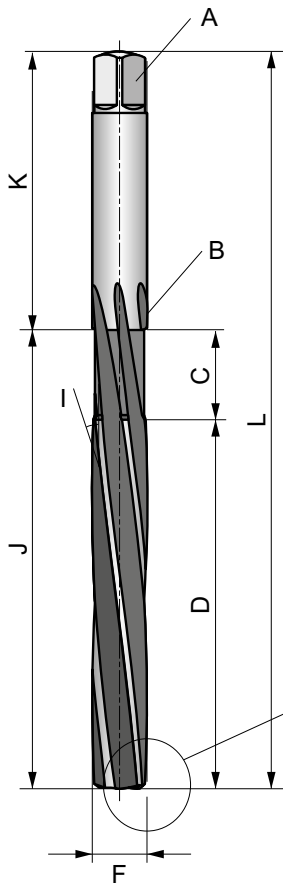

A	Tang or Square Drive
B	Recess Diameter
C	Recess Length
D	Cut Length
E	Bevel Lead Length
F	Diameter

G	Bevel Lead
H	Bevel Lead Angle
I	Helix Angle
J	Body Length
K	Shank Length
L	Overall Length

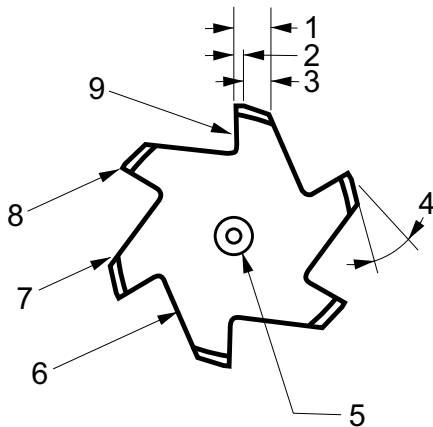
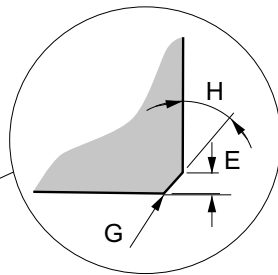

1	Width of Land
2	Circular Land
3	Clearance
4	Clearance Angle
5	Centre Hole
6	Flute
7	Heel
8	Cutting Edge
9	Face

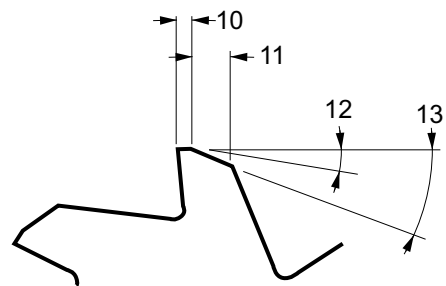

10	Width of Primary Clearance
11	Width of Secondary Clearance
12	Primary Clearance Angle
13	Secondary Clearance Angle



REAMING – TECHNICAL INFO

Reaming

To obtain the best results when using reamers it is essential to make them 'work'. It is a common fault to prepare holes for reaming with too little stock left in the starting hole diameter. If insufficient stock is left in the hole before reaming, the reamer will rub, quickly show wear and will result in loss of diameter. It is equally important for performance not to leave too much stock in the hole. (See Stock removal below).

1. Select the optimum type of reamer and the optimum speeds and feeds for the application. Ensure that pre-drilled holes are the correct diameter.
2. The workpiece must be held rigid and the machine spindle should have no play.
3. The chuck for straight shank reamers must be of good quality and in good working condition. If the reamer slips in the chuck and the feed is automatic, breakage of the reamer may occur.

4. Keep tool overhang from machine spindle to a minimum.
5. Use recommended lubricants to enhance the life of the reamer and ensure the fluid reaches the cutting edges. As reaming is not a heavy cutting operation, soluble oil 40:1 dilution is normally satisfactory. Air blasting may be used with grey cast iron, if dry machining.
6. Do not allow the flutes of a reamer to become blocked with chips. Retract if necessary to empty the flutes, this can help to prevent poor hole quality and breakage of the tool.
7. Before the reamer is reground, check concentricity between centres. In most instances only the bevel lead will need regrinding.
8. Keep reamers sharp. Frequent regrinding is good economy, but it is important to understand that reamers cut only on the bevel and taper leads and not on the lands. Consequently only these leads need regrinding. Accuracy of regrinding is important to hole quality and tool life.

Stock removal

The recommended stock removal in reaming is dependent on the application material and the surface finish of the pre-drilled hole. General guidelines for stock removal are shown in the following tables:

Size of reamed hole [mm]	When pre-drilled	When pre-core-drilled
Below 4	0.1	0.1
Over 4 to 11	0.2	0.15
Over 11 to 39	0.3	0.2
Over 39 to 50	0.4	0.3

Size of reamed hole [inches]	When pre-drilled	When pre-core-drilled
Below 3/16"	0.004"	0.004"
3/16 to 1/2"	0.008"	0.006"
1/2 to 1 1/2"	0.010"	0.008"
1 1/2 to 2"	0.016"	0.010"

Hand/Machine reaming

Although both hand and machine reamers offer the same capability regarding finished hole size, the use of each must be considered according to the application. A hand reamer, for reasons of alignment, has a long taper lead, whereas a machine reamer has only a 45 degree bevel lead. A machine reamer cuts only on the bevel lead while a hand reamer cuts on the bevel lead as well as the taper lead.



REAMING – TOLERANCE LIMITS – TECHNICAL INFO

Tolerance limits

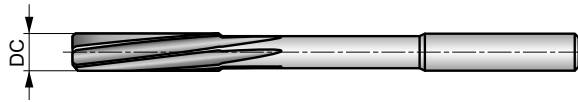

1. On the cutting diameter of standard reamers

The diameter (DC) is measured across the circular land immediately behind the bevel or taper lead. The tolerance is in accordance with DIN 1420 and is intended to produce H7 holes.

Reamer tolerance			
Diameter [mm]		Tolerance Limit [mm]	
Over	Up to and including	High +	Low +
–	3	0.008	0.004
3	6	0.010	0.005
6	10	0.012	0.006
10	18	0.015	0.008

Reamer tolerance			
Diameter [mm]		Tolerance Limit [mm]	
Over	Up to and including	High +	Low +
18	30	0.017	0.009
30	50	0.021	0.012
50	80	0.025	0.014

2. H7 hole tolerance

The most common tolerance on a finished hole is H7 (see table below). For any other tolerance the figure and table below (in Note 3) can be used to calculate the reamers tolerance location and width

Hole tolerance			
Diameter [mm]		Tolerance Limit [mm]	
Over	Up to and including	High +	Low +
–	3	0.010	0
3	6	0.012	0
6	10	0.015	0
10	18	0.018	0

Hole tolerance			
Diameter [mm]		Tolerance Limit [mm]	
Over	Up to and including	High +	Low +
18	30	0.021	0
30	50	0.025	0
50	80	0.030	0

3. Other hole tolerances when it is necessary to define the dimensions of a special reamer intended to cut to a specific tolerance, e.g. D8, this well proven guide can be used.

Diameter tolerance width [μm]								
Tolerance width (microns)	over 1 incl. 3	over 3 incl. 6	over 6 incl. 10	over 10 incl. 18	over 18 incl. 30	over 30 incl. 50	over 50 incl. 80	over 80 incl. 120
IT5	4	5	6	8	9	11	13	15
IT6	6	8	9	11	13	16	19	22
IT7	10	12	15	18	21	25	30	35
IT8	14	18	22	27	33	39	46	54
IT9	25	30	36	43	52	62	74	87
IT10	40	48	58	70	84	100	120	140
IT11	60	75	90	110	130	160	190	220
IT12	100	120	150	180	210	250	300	350

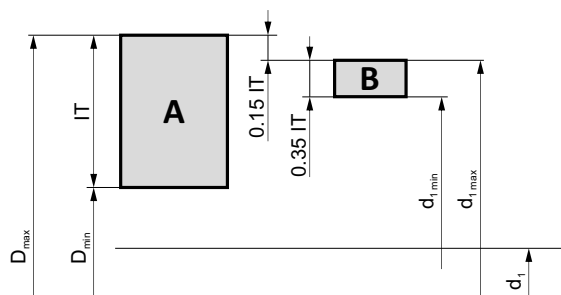

- A** = Hole tolerance
- B** = Reamer tolerance
- IT** = Tolerance width
- D_{max} = Max. diameter of hole
- D_{min} = Min. diameter of hole
- d_1 = Nominal diameter
- d_{1max} = Max. diameter of reamer
- d_{1min} = Min. diameter of reamer

e.g. 10 mm hole with tolerance D8, Max dia = 10.062, Min dia = 10.040, Hole tolerance (IT8) = 0.022

Maximum limit: $0.15 \times \text{hole tolerance (IT8)} = 0.0033$, rounded up = 0.004

Minimum limit: $0.35 \times \text{hole tolerance (IT8)} = 0.0077$, rounded up = 0.008

Maximum limit for reamer = $10.062 - 0.004 = 10.058$

Minimum limit for reamer = $10.058 - 0.008 = 10.050$



REAMING – TECHNICAL INFO

Applications – Reamer Selection

The most common types of reamers have a left-hand spiral because the main applications involve through holes requiring chips to be pushed forward. For blind holes, reamers with straight flutes or right hand spirals are recommended.

The most efficient reaming conditions depend on the application, material, quality of hole required, stock removal, lubrication and other factors. A general guide to surface speeds and feeds for

machine reamers is shown in the reamer WMG and feed charts (see Product Selector) and stock removal tables.

Extremely unequal spacing on reamers means that the divide is not the same for each tooth. As there are no two teeth diametrically opposite each other, the reamer produces a hole with a roundness variance of between 1 and 2 μm . This compared with a variance of up to 10 μm with conventional unequal spacing.

Carbide Reamers – Comparison spacing / EU spacing

Unequal spacing
Roundness error up to 10 μm

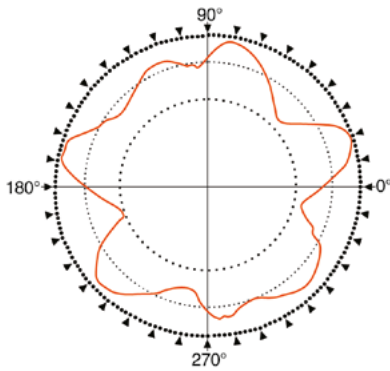

Results of roundness

Extremely unequal spacing
Roundness error up to 1 – 2 μm

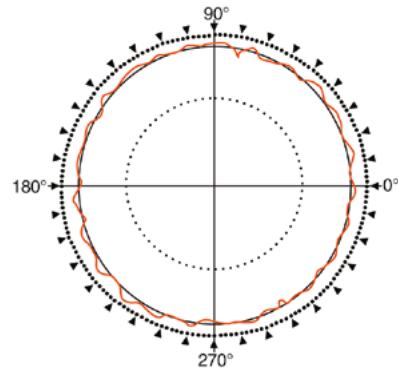

Results of roundness



REAMING – GENERAL HINTS – TECHNICAL INFO

Trouble shooting when reaming

Problem	Cause	Remedy
Broken or twisted tangs	Incorrect fit between shank and socket	Ensure the shank and socket are clean and free from damage
Rapid tool wear	Insufficient stock to remove	Increase the amount of stock to be removed (smaller hole)
Oversize hole	Excessive lip height variation	Regrind to correct specification
	Displacement in the machine spindle	Repair and rectify spindle displacement
	Defects on the tool holder	Replace tool holder
	Tool shank is damaged	Replace or regrind the shank
	Ovality of the tool	Replace or regrind the tool
	Asymmetric bevel lead angle	Regrind to correct specification
	Too high feed or cutting speed	Adjust cutting conditions in accordance with Catalogue
Undersize hole	Insufficient stock to remove	Increase the amount of stock to be removed (smaller hole)
	Too much heat generated while reaming. The hole widens and shrinks	Increase coolant flow
	The tool diameter is worn and is undersize	Regrind to correct specification or replace tool
	Too low feed or cutting speed	Adjust cutting conditions in accordance with the Catalogue
	Pre-drilled hole is too small	Decrease the amount of stock to be removed (larger hole)
Oval and conical holes	Displacement in the machine spindle	Repair and rectify spindle displacement
	Misalignment between tool and hole	Use a bridge reamer
	Asymmetric bevel lead angle	Regrind to correct specification
Bad hole finish	Excessive stock to remove	Decrease the amount of stock to be removed (larger hole)
	Worn out tool	Regrind to correct specification
	Undersize cutting rake angle	Regrind to correct specification
	Too diluted emulsion or cutting oil	Increase % concentration
	Feed and/or speed too low	Adjust cutting conditions in accordance with Catalogue
	Cutting speed too high	Adjust cutting conditions in accordance with Catalogue
The tool clamps and breaks	Worn out tool	Regrind to correct specification
	Back taper of the tool is too small	Check and replace/modify the tool
	The width of the land is too wide	Check and replace/modify the tool
	Workpiece material tend to squeeze	Use an adjustable reamer to compensate for the displacement
	Pre-drilled hole is too small	Decrease the amount of stock to be removed (larger hole)
	Heterogeneous material with hard inclusions	Use solid carbide reamer



GENERAL – TECHNICAL INFO

	Grade	Hardness (HV10)	C %	W %	Mo %	Cr %	V %	Co %	Tool Material
	M2	810 – 850	0.9	6.4	5.0	4.2	1.8	–	HSS
	M35	830 – 870	0.93	6.4	5.0	4.2	1.8	4.8	HSCO
	M42	870 – 960	1.08	1.5	9.4	3.9	1.2	8.0	

Properties	HSS materials	Carbide materials	K10/30F (often used for solid tools)
Hardness [HV30]	800-950	1300 – 1800	1600
Density [g/cm ³]	8.0 – 9.0	7.2 – 15	14.45
Compressive strength [N/mm ²]	3000 – 4000	3000 – 8000	6250
Flexural strength, (bending) [N/mm ²]	2500 – 4000	1000 – 4700	4300
Heat resistance [°C]	550	1000	900
E-module [KN/mm ²]	260 – 300	460 – 630	580
Grain size [µm]	–	0.2 – 10	0.8

The combination of hard particle (WC) and binder metal (Co) give the following changes in characteristics.

Characteristic	Higher WC content give	Higher Co content give
Hardness	Higher hardness	Lower hardness
Compressive strength [CS]	Higher CS	Lower CS
Bending strength [BS]	Lower BS	Higher BS

Grain size also influences the material properties. Small grain sizes means higher hardness and coarse grains give more toughness.

Surface treatment / Coating properties examples

Surface Treatments	Colour	Coating material	Hardness [HV]	Thickness [µm]	Coating structure	Frict. coeff. against steel	Max. appl. temp. [°C]
	Gold	TiN	2300	1-4	Mono-layer	0.4	600
	Black grey	TiAlN	3300	3	Nano structured	0.3-0.35	900



GENERAL – TECHNICAL INFO

Industry Standard tolerances For Shafts & Holes

Tolerance values are shown in Microns (μm)

Formula for Microns ...1 $\mu\text{m} = 0.001 \text{ mm} / 0.000039''$

Tolerance	Diameter [mm]							
	> 1 ≤ 3	> 3 ≤ 6	> 6 ≤ 10	> 10 ≤ 18	> 18 ≤ 30	> 30 ≤ 50	> 50 ≤ 80	> 80 ≤ 120
	Diameter [inch]							
	> 0.039" ≤ 0.118"	> 0.118" ≤ 0.236"	> 0.236" ≤ 0.394"	> 0.394" ≤ 0.709"	> 0.709" ≤ 1.181"	> 1.181" ≤ 1.968"	> 1.968" ≤ 3.149"	> 3.149" ≤ 4.724"
	Tolerance values [μm]							
e8	-14 / -28	-20 / -38	-25 / -47	-32 / -59	-40 / -73	-50 / -89	-60 / -106	-72 / -126
f6	-6 / -12	-10 / -18	-13 / -22	-16 / -27	-20 / -33	-25 / -41	-30 / -49	-36 / -58
f7	-6 / -16	-10 / -22	-13 / -28	-16 / -34	-20 / -41	-25 / -50	-30 / -60	-36 / -71
h6	0 / -6	0 / -8	0 / -9	0 / -11	0 / -13	0 / -16	0 / -19	0 / -22
h7	0 / -10	0 / -12	0 / -15	0 / -18	0 / -21	0 / -25	0 / -30	0 / -35
h8	0 / -14	0 / -18	0 / -22	0 / -27	0 / -33	0 / -39	0 / -46	0 / -54
h9	0 / -25	0 / -30	0 / -36	0 / -43	0 / -52	0 / -62	0 / -74	0 / -87
h10	0 / -40	0 / -48	0 / -58	0 / -70	0 / -84	0 / -100	0 / -120	0 / -140
h11	0 / -60	0 / -75	0 / -90	0 / -110	0 / -130	0 / -160	0 / -190	0 / -220
h12	0 / -100	0 / -120	0 / -150	0 / -180	0 / -210	0 / -250	0 / -300	0 / -350
k10	+40 / 0	+48 / 0	+58 / 0	+70 / 0	+84 / 0	+100 / 0	+120 / 0	+140 / 0
k12	+100 / 0	+120 / 0	+150 / 0	+180 / 0	+210 / 0	+250 / 0	+300 / 0	+350 / 0
m7	+2 / +12	+4 / +16	+6 / +21	+7 / +25	+8 / +29	+9 / +34	+11 / +41	+13 / +48
js14	+/-125	+/-150	+/-180	+/-215	+/-260	+/-310	+/-370	+/-435
js16	+/-300	+/-375	+/-450	+/-550	+/-650	+/-800	+/-950	+/-1100
H7	+10 / 0	+12 / 0	+15 / 0	+18 / 0	+21 / 0	+25 / 0	+30 / 0	+35 / 0
H8	+14 / 0	+18 / 0	+22 / 0	+27 / 0	+33 / 0	+39 / 0	+46 / 0	+54 / 0
H9	+25 / 0	+30 / 0	+36 / 0	+43 / 0	+52 / 0	+62 / 0	+74 / 0	+87 / 0
H12	+100 / 0	+120 / 0	+150 / 0	+180 / 0	+210 / 0	+250 / 0	+300 / 0	+350 / 0
P9	-6 / -31	-12 / -42	-15 / -51	-18 / -61	-22 / -74	-26 / -86	-32 / -106	-37 / -124
S7	-13 / -22	-15 / -27	-17 / -32	-21 / -39	-27 / -48	-34 / -59	-42 / -72	-58 / -93



GENERAL – TECHNICAL INFO

Table of Cutting Speeds

		Vc															
m/min.		5	8	10	15	20	25	30	40	50	60	70	80	90	100	110	150
SFM (feet/min.)		16	26	32	50	66	82	98	130	165	197	230	262	296	330	362	495
Ø		RPM															
mm	inch																
1.00	–	1592	2546	3183	4775	6366	7958	9549	12732	15916	19099	22282	25465	28648	31831	35014	47747
1.50	–	1061	1698	2122	3183	4244	5305	6366	8488	10610	12732	14854	16977	19099	21221	23343	31831
2.00	–	796	1273	1592	2387	3183	3979	4775	6366	7958	9549	11141	12732	14324	15916	17507	23873
2.50	–	637	1019	1273	1910	2546	3183	3820	5093	6366	7639	8913	10186	11459	12732	14006	19099
3.00	–	531	849	1061	1592	2122	2653	3183	4244	5305	6366	7427	8488	9549	10610	11671	15916
3.18	1/8	500	801	1001	1501	2002	2502	3003	4004	5005	6006	7007	8008	9009	10010	11011	15015
3.50	–	455	728	909	1364	1819	2274	2728	3638	4547	5457	6366	7276	8185	9095	10004	13642
4.00	–	398	637	796	1194	1592	1989	2387	3183	3979	4775	5570	6366	7162	7958	8754	11937
4.50	–	354	566	707	1061	1415	1768	2122	2829	3537	4244	4951	5659	6366	7074	7781	10610
4.76	3/16	334	535	669	1003	1337	1672	2006	2675	3344	4012	4681	5350	6018	6687	7356	10031
5.00	–	318	509	637	955	1273	1592	1910	2546	3183	3820	4456	5093	5730	6366	7003	9549
6.00	–	265	424	531	796	1061	1326	1592	2122	2653	3183	3714	4244	4775	5305	5836	7958
6.35	1/4	251	401	501	752	1003	1253	1504	2005	2506	3008	3509	4010	4511	5013	5514	7519
7.00	–	227	364	455	682	909	1137	1364	1819	2274	2728	3183	3638	4093	4547	5002	6821
7.94	5/16	200	321	401	601	802	1002	1203	1604	2004	2405	2806	3207	3608	4009	4410	6013
8.00	–	199	318	398	597	796	995	1194	1592	1989	2387	2785	3183	3581	3979	4377	5968
9.00	–	177	283	354	531	707	884	1061	1415	1768	2122	2476	2829	3183	3537	3890	5305
9.53	3/8	167	267	334	501	668	835	1002	1336	1670	2004	2338	2672	3006	3340	3674	5010
10.00	–	159	255	318	477	637	796	955	1273	1592	1910	2228	2546	2865	3183	3501	4775
11.11	7/16	143	229	287	430	573	716	860	1146	1433	1719	2006	2292	2579	2865	3152	4298
12.00	–	133	212	265	398	531	663	796	1061	1326	1592	1857	2122	2387	2653	2918	3979
12.70	1/2	125	201	251	376	501	627	752	1003	1253	1504	1754	2005	2256	2506	2757	3760
14.00	–	114	182	227	341	455	568	682	909	1137	1364	1592	1819	2046	2274	2501	3410
14.29	9/16	111	178	223	334	446	557	668	891	1114	1337	1559	1782	2005	2228	2450	3341
15.00	–	106	170	212	318	424	531	637	849	1061	1273	1485	1698	1910	2122	2334	3183
15.88	5/8	100	160	200	301	401	501	601	802	1002	1203	1403	1604	1804	2004	2205	3007
16.00	–	99	159	199	298	398	497	597	796	995	1194	1393	1592	1790	1989	2188	2984
17.46	11/16	91	146	182	273	365	456	547	729	912	1094	1276	1458	1641	1823	2005	2735
18.00	–	88	141	177	265	354	442	531	707	884	1061	1238	1415	1592	1768	1945	2653
19.05	3/4	84	134	167	251	334	418	501	668	835	1003	1170	1337	1504	1671	1838	2506
20.00	–	80	127	159	239	318	398	477	637	796	955	1114	1273	1432	1592	1751	2387
24.00	–	66	106	133	199	265	332	398	531	663	796	928	1061	1194	1326	1459	1989
25.00	–	64	102	127	191	255	318	382	509	637	764	891	1019	1146	1273	1401	1910
27.00	–	59	94	118	177	236	295	354	472	589	707	825	943	1061	1179	1297	1768
30.00	–	53	85	106	159	212	265	318	424	531	637	743	849	955	1061	1167	1592
32.00	–	50	80	99	149	199	249	298	398	497	597	696	796	895	995	1094	1492
36.00	–	44	71	88	133	177	221	265	354	442	531	619	707	796	884	973	1326
40.00	–	40	64	80	119	159	199	239	318	398	477	557	637	716	796	875	1194
50.00	–	32	51	64	95	127	159	191	255	318	382	446	509	573	637	700	955



GENERAL – TECHNICAL INFO

Hardness and Tensile Strength

HV	HRC	HB	Tensile Strength	
			[N/mm ²]	[Tons/sq. in.]
940	68	–	–	–
900	67	–	–	–
864	66	–	–	–
829	65	–	–	–
800	64	–	–	–
773	63	–	–	–
745	62	–	–	–
720	61	–	–	–
698	60	–	–	–
675	59	–	–	–
655	58	–	2200	142
650	–	618	2180	141
640	–	608	2145	139
639	57	607	2140	138
630	–	599	2105	136
620	–	589	2070	134
615	56	584	2050	133
610	–	580	2030	131
600	–	570	1995	129
596	55	567	1980	128
590	–	561	1955	126
580	–	551	1920	124
578	54	549	1910	124
570	–	542	1880	122
560	53	532	1845	119
550	–	523	1810	117
544	52	517	1790	116
540	–	513	1775	115
530	–	504	1740	113
527	51	501	1730	112
520	–	494	1700	110
514	50	488	1680	109
510	–	485	1665	108
500	–	475	1630	105
497	49	472	1620	105
490	–	466	1595	103
484	48	460	1570	102
480	–	456	1555	101
473	47	449	1530	99
470	–	447	1520	98
460	–	437	1485	96
458	46	435	1480	96
450	–	428	1455	94
446	45	424	1440	93
440	–	418	1420	92

HV	HRC	HB	Tensile Strength	
			[N/mm ²]	[Tons/sq. in.]
434	44	413	1400	91
423	43	402	1360	88
413	42	393	1330	86
403	41	383	1300	84
392	40	372	1260	82
382	39	363	1230	80
373	38	354	1200	78
364	37	346	1170	76
355	36	337	1140	74
350	–	333	1125	73
345	35	328	1110	72
340	–	323	1095	71
336	34	319	1080	70
330	–	314	1060	69
327	33	311	1050	68
320	–	304	1030	67
317	32	301	1020	66
310	31	295	995	64
302	30	287	970	63
300	–	285	965	62
295	–	280	950	61
293	29	278	940	61
290	–	276	930	60
287	28	273	920	60
285	–	271	915	59
280	27	266	900	58
275	–	261	880	57
272	26	258	870	56
270	–	257	865	56
268	25	255	860	56
265	–	252	850	55
260	24	247	835	54
255	23	242	820	53
250	22	238	800	52
245	–	233	785	51
243	21	231	780	50
240	–	228	770	50
235	–	223	755	49
230	–	219	740	48
225	–	214	720	47
220	–	209	705	46
215	–	204	690	45
210	–	199	675	44
205	–	195	660	43
200	–	190	640	41



**EXCHANGEABLE HEAD
INDEXABLE DRILLS**





HOLEMAKING – GENERAL CONTENT

6		WMG & ISO 13399
12	DRILLS	INSTRUCTIONS
15		SOLID CARBIDE DRILLS
66		HSS DRILLS
176		CUTTING FLUIDS
186		TECHNICAL INFORMATION
190		REAMERS AND COUNTERSINKS
264	INDEXABLE DRILLS	INSTRUCTIONS
271		HYDRA DRILLS
297		TECHNICAL INFORMATION
307		INDEXABLE DRILLS
327		TECHNICAL INFORMATION
350	BORING SYSTEMS	INSTRUCTIONS
359		BORING HEADS
376		BORING ACCESSORIES
381		INSERTS
404		ARBORS
418		BORING KITS
429		TECHNICAL INFORMATION



1 SCET

	IC	D1	L	S
	[mm]	[mm]	[mm]	[mm]
0502	5.556	2.40	5.56	2.38
0602	6.350	2.90	6.35	2.38
0703	7.937	3.50	7.94	3.18
09T3	9.525	4.50	9.53	3.97
1204	12.700	5.60	12.70	4.76
1505	15.875	5.60	15.88	5.56

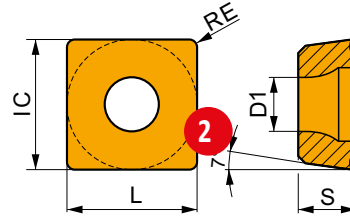

Suitability and starting values for cutting speed (vc), feed (f) and depth of cut (ap). Refer to our Machining Calculator app for further calculations.

Product	RE [mm]	P			M			K			N			S			H		
		vc [m/min]	f [mm/rev]	ap [mm]	vc [m/min]	f [mm/rev]	ap [mm]	vc [m/min]	f [mm/rev]	ap [mm]	vc [m/min]	f [mm/rev]	ap [mm]	vc [m/min]	f [mm/rev]	ap [mm]			

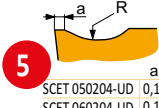

UD geometry with universal design for periphery inserts.

- SCET 050204-UD 0,12
- SCET 060204-UD 0,15
- SCET 070308-UD 0,15
- SCET 09T308-UD 0,15
- SCET 120408-UD 0,20
- SCET 150512-UD 0,20

SCET 050204-UD	D8330	0.4	165	0.08	-	-	-	-	155	0.08	-	-	-	-	-	-	-	-
	D9335	0.4	240	0.08	-	-	-	-	225	0.08	-	-	-	-	-	-	-	-
SCET 060204-UD	D8330	0.4	165	0.11	-	-	-	-	155	0.11	-	-	-	-	-	-	-	-
	D9335	0.4	240	0.11	-	-	-	-	225	0.11	-	-	-	-	-	-	-	-
SCET 070308-UD	D8330	0.8	165	0.13	-	-	-	-	155	0.13	-	-	-	-	-	-	-	-
	D9335	0.8	240	0.13	-	-	-	-	225	0.13	-	-	-	-	-	-	-	-
SCET 09T308-UD	D8330	0.8	165	0.14	-	-	-	-	155	0.14	-	-	-	-	-	-	-	-
	D9335	0.8	240	0.14	-	-	-	-	225	0.14	-	-	-	-	-	-	-	-
SCET 120408-UD	D8330	0.8	165	0.16	-	-	-	-	155	0.16	-	-	-	-	-	-	-	-
	D9335	0.8	240	0.16	-	-	-	-	225	0.16	-	-	-	-	-	-	-	-
SCET 150512-UD	D8330	1.2	165	0.18	-	-	-	-	155	0.18	-	-	-	-	-	-	-	-
	D9335	1.2	240	0.18	-	-	-	-	225	0.18	-	-	-	-	-	-	-	-

SCET120408-UD:D9335 Use full insert specification code when ordering!

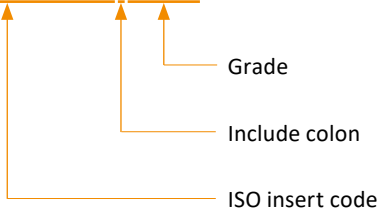



INSERTS – PAGE OVERVIEW

Pos.	Description	Pos.	Description
1	Designation of insert	7	ISO insert code
2	Schematic drawing of insert	8	Grade
3	Table with insert sizes [mm]	9	Insert radii [mm]
4	Picture of representative insert	10	Geometry description
5	Profile of main cutting edge	11	Application area of insert
6	Icons – specific features and cutting edge type		



INDEXABLE DRILLS – PAGE OVERVIEW

1 **802D** **P M K N S** **2** **PRAMET** **3** **S**



2xD Indexable Insert Drill body with Internal Coolant Feed
 High performance indexable insert drill body for drilling blind and through holes. Also, potentially cross hole, off center and stack drilling, helical interpolation, plunging, drilling on concave or angled surface. Capable of drilling with interrupted cuts, chamfer drilling and boring. Available from Ø15 to Ø40 mm in 2xD.

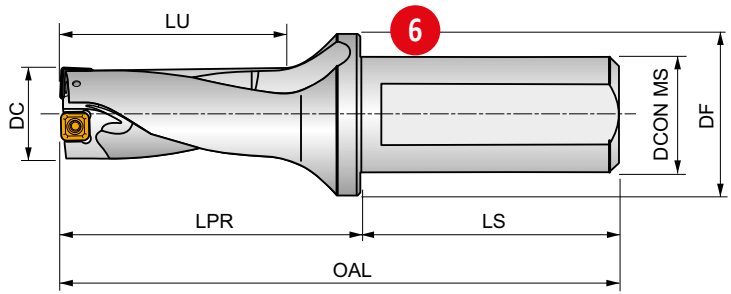

2xD **1** **ISO 9766**
7



Product	DC	APMX	OAL	LPR	LS	LU	DCON MS	DF	\bar{D}	D^+						
	[mm]	[mm]	[mm]	[mm]	[mm]	[mm]	[mm]	[mm]	[mm]	[mm]						
802D-15-30-S25	15	30.00	121	65	56	34.5	25	35	0.25	0.35	EP253253	GI300	GI313	0.30	HM001	
802D-16-32-S25	16	32.00	123	67	56	37	25	35	0.45	0.45	EP253253	GI300	GI313	0.30	HM001	
802D-17-34-S25	17	34.00	125	69	56	39.5	25	35	0.50	0.50	EP253253	GI301	GI314	0.31	HM002	
802D-18-36-S25	18	36.00	127	71	56	42	25	35	0.35	0.25	EP253253	GI301	GI314	0.31	HM002	
802D-19-38-S25	19	38.00	129	73	56	44.5	25	35	0.15	0.45	EP253253	GI301	GI314	0.32	HM002	

GI300	XPET 0502AP				SCET 050204-UD
GI301	XPET 0602AP				SCET 050204-UD
GI302	XPET 0602AP				SCET 060204-UD
GI303	XPET 0703AP				SCET 060204-UD
GI304	XPET 0703AP				SCET 070308-UD
GI305	XPET 0903AP			17	SCET 070308-UD
GI306	XPET 0903AP				SCET 09T308-UD
GI307	XPET 11T3AP				SCET 09T308-UD
GI308	XPET 11T3AP				SCET 120408-UD
GI309	XPET 12T3AP				SCET 120408-UD
GI313	XPET 0502AP-SD				SCET 050204-SD
GI314	XPET 0602AP-SD				SCET 050204-SD
GI315	XPET 0602AP-SD				SCET 060204-SD
GI316	XPET 0703AP-SD				SCET 060204-SD
GI317	XPET 0703AP-SD				SCET 070308-SD
GI318	XPET 0903AP-SD				SCET 070308-SD
GI319	XPET 0903AP-SD			18	SCET 09T308-SD
GI320	XPET 11T3AP-SD				SCET 09T308-SD
GI321	XPET 11T3AP-SD				SCET 120408-SD
GI322	XPET 12T3AP-SD				SCET 120408-SD

GI300	XPET 0502AP				SCET 050204-UD
GI301	XPET 0602AP				SCET 050204-UD
GI302	XPET 0602AP			19	SCET 060204-UD
GI303	XPET 0703AP				SCET 060204-UD



INDEXABLE DRILLS – PAGE OVERVIEW

Pos.	Description	Pos.	Description
1	Designation of drill	11	Radial setting [mm]
2	Material group recommendations	12	Adjustable sleeve
3	Clamping system of insert	13	Group of compatible inserts with chip breaker UD ^{1),2)}
4	Tool description	14	Group of compatible inserts with chip breaker SD ^{1),2)}
5	Illustrative picture	15	Weight [kg]
6	Schematic drawing of tool	16	Group of spare parts ¹⁾
7	Product features	17	Compatible inserts with chip breaker UD
8	Product applications	18	Compatible inserts with chip breaker SD
9	Tool code	19	Spare parts
10	Tool dimensions		

¹⁾ Code of Group of compatible inserts and spare parts is used only for purposes of this catalogue. It cannot be used for orders.

²⁾ External (SCET) and internal (XPET) inserts must always have the same chip breaker (please note: UD chip breaker is not visibly included in designation of XPET inserts – e.g. XPET 0502AP); info needed for correct choice of chip breaker (UD vs SD) can be found on the insert packaging.



1 H851



HYDRA Body 1.5XD, with Coolant Feed, Bright Nickel Plating

Used with R950, R960 and R970 HYDRA heads. A range of diameters can be used with the same body. Coolant holes aligned with the heads offer efficient cooling. Flanged shank prevents the drill from wandering in the holder. Nickel Plated surface protects from rust and corrosion, and improves chip evacuation.

HYDRA

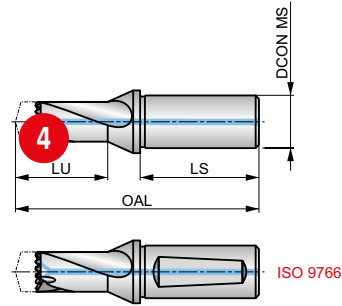

HSS	DORMER	1.5×D
Bright Ni	ISO 9766	R

Four (4) screws and one (1) screwdriver are included with a drill body, DCON MS tolerance h6.

Product	DCONMS	DCON MS	LU	OAL	LS	ADINTMS
	[inch]	[mm]	[mm]	[mm]	[mm]	
H85131/64	5/8	15.88	25.50	88.5	47.6	Cylindrical
H8511/2	5/8	15.88	25.80	88.8	47.6	Cylindrical
H85117/32	5/8	15.88	30.90	93.9	47.6	Cylindrical
H85112.0	–	16.00	25.50	88.5	48.0	ISO 9766
H85112.5	–	16.00	25.80	88.8	48.0	ISO 9766
H85113.0	–	16.00	27.00	90.0	48.0	ISO 9766
H85114.0	–	16.00	30.90	93.9	48.0	ISO 9766
H8519/16	3/4	19.05	30.30	93.9	50.8	Cylindrical
H85139/64	3/4	19.05	32.30	97.3	50.8	Cylindrical
H85114/64	3/4	19.05	39.00	101.4	50.8	Cylindrical
H85116	3/4	19.05	39.00	101.4	50.8	Cylindrical
H85123/32	3/4	19.05	39.00	104.0	50.8	Cylindrical
H85115.0	–	20.00	32.30	97.3	50.0	ISO 9766
H85116.0	–	20.00	34.90	99.9	50.0	ISO 9766
H85117.0	–	20.00	36.40	101.4	50.0	ISO 9766
H85118.0	–	20.00	39.00	104.0	50.0	ISO 9766
H85119.0	–	25.00	40.40	111.4	56.0	ISO 9766
H85120.0	–	25.00	43.00	114.0	56.0	ISO 9766
H85121.0	–	25.00	44.50	116.5	56.0	ISO 9766

Pos.	Description
1	Designation of drill
2	Product description
3	Illustrative picture
4	Schematic drawing of tool

Pos.	Description
5	Product features
6	Product code
7	Product dimensions



EXCHANGEABLE HEAD & INDEXABLE DRILLS – ICONS OVERVIEW

General Icons



Primary use



Possible use

Basic Standard Group (BSG)



Dormer Standards

Clamping Designation



S – Screw clamp

Application Angle



Drill Point 140°

Coating



Bright Nickel Plating



Special TiAlN Coating (+ Silicon + Chromium)

Coolant Supply Property (CSP)



Through Tool Coolant

Cutting Diameter Tolerance Zone Class (TCDC)



h7 – Industry Standard Tool Tolerance Zone (based on diameter range)

Cutting Direction



Right Hand Rotation / Cutting

General Features of Tools



1 effective tooth per revolution



Monoblock design



Possibility of use for eccentric machining



Universal shank

Insert cutting Edge



Rounded edge with facet

Insert Features



For tough machined materials (long chip)



Heavy working conditions



Universal wide range option

Material Code (BMC)

HM

Hard Material (Solid Carbide)

HSS

High Speed Steel Tool Material

Operations Drilling



Blind hole boring



Blind hole drilling



Boring



Boring through cross holes



Boring up to a shoulder



Drill exit on inclined surface



Drilling across an existing hole



Drilling of stacked materials



Drilling onto curved surface



Drilling onto inclined surface



Helical interpolation boring



Helical interpolation drilling



Chamfering (beveling)



Interrupted cut



Through hole boring



Through hole drilling



Welded joint drilling



EXCHANGEABLE HEAD & INDEXABLE DRILLS – ICONS OVERVIEW

Other Icons

 Clamping torque of screw [Nm]

Shank

 Cylindrical Shank with Flange

 ISO 9766 Cylindrical Shanks (with or without Flat)

 DIN 6535 – HB (Weldon) or HE (Whistle Notch) Shank

Technical Pages

 Feed [mm/rev]

 High cutting speed, system rigidity slightly limited (depth of cut changing)

 Low cutting speed, low system rigidity (interrupted cut)

 Very high cutting speed, excellent system rigidity (stable working conditions)

 Medium cutting speed, system rigidity limited (slightly interrupted cut)

 Very low cutting speed, very low system rigidity (very unstable working conditions)

 High cutting speed, high system rigidity (stable working conditions)

Usable Length Diameter Ratio (ULDR)

 1.5xD Usable Tool Depth to Diameter Ratio

 5xD Usable Tool Depth to Diameter Ratio

 2xD Usable Tool Depth to Diameter Ratio

 12xD Usable Tool Depth to Diameter Ratio

 8xD Usable Tool Depth to Diameter Ratio

 4xD Usable Tool Depth to Diameter Ratio

 3xD Usable Tool Depth to Diameter Ratio



HYDRA DRILLS



HYDRA

HIGH PERFORMANCE REPLACEABLE HEAD DRILLS

Interchangeable solid carbide head drills for high performance machining of steels, stainless steels and cast iron. Fail-safe head location can be changed without ejecting the drill from the machine. Available with coolant feed and a choice of HSS bodies from 1.5×D for improved rigidity in shallow hole and plate drilling, through to 12×D for deeper hole applications.

FEATURES AND BENEFITS

- **Consistently high performance**, even after numerous head changes.
- **Reduction in inventory costs** – one body can fit multiple solid carbide head sizes.
- **Versatile** – cylindrical shank with flat allows use in multiple types of holder.
- **Easy and quick head changes** with minimal interruptions to the production process. Heads can be changed without removing the body from the machine.
- Exact fit of head to body maximises tool rigidity for **superior hole accuracy** and precise tolerances.

MATERIAL

PREMIUM MICROGRAIN CARBIDE (Heads)

- Micrograin carbide provides an excellent combination of hardness and toughness, resulting in high wear resistance and longer tool life.

HARDENED STEEL (Body)

- Hardened steel with high gloss nickel plating for high resistance to wear and corrosion.

COATING

TITANIUM ALUMINIUM NITRIDE BASED COATING PROVIDES:

- High toughness and oxidation resistance.
- Outstanding wear protection in abrasive materials like Cast Iron.
- High hardness at high temperatures created when drilling Cast Irons.
- Increased tool life and productivity.

HEAD TYPES



R950

STEEL



R960

STAINLESS STEEL



R970

CAST IRON



HYDRA

HIGH PERFORMANCE REPLACEABLE HEAD DRILLS

GEOMETRY

CORNER DESIGN

- A strong corner design increases stability during drilling and reduces the forces encountered during breakthrough of the exit surface.
- This improves the quality of the exit surface and helps prevent “exit burst” which can occur when drilling granular materials.

POINT GEOMETRY

- 140 degree split point geometry provides good centering capabilities and low thrust forces when drilling most materials.

A COMPLETE RANGE

- Available in 1.5xD, 3xD, 5xD, 8xD and 12xD lengths incorporating coolant holes to improve cutting efficiency and swarf evacuation, resulting in higher productivity.
- Metric: 12.00 mm to 42.00 mm.
- Fractional: 15/32 inch to 1.5/8 inch.
- Best results are obtained using hydraulic holders. Can also be held in ER and Weldon type toolholders.



BODY LENGTHS

1.5xD



3xD



5xD



8xD



12xD





HYDRA DRILLS – NAVIGATOR TOOL MATERIALS



Tool materials

High Speed Steel		A medium-alloyed high speed steel that has good machinability and good performance. HSS exhibits hardness, toughness and wear resistance characteristics that make it attractive in a wide range of applications, for example in drills and taps.
-------------------------	---	---

Carbide materials

Carbide Materials (or Hard Materials)		<p>A sintered powder metallurgy substrate, consisting of a metallic carbide composite with binder metal. The most central raw material is tungsten carbide (WC). Tungsten carbide contributes to the hardness of the material. Tantalum carbide (TaC), titanium carbide (TiC) and niobium carbide (NbC) complements WC and adjusts the properties to what is desired. These three materials are called cubic carbides. Cobalt (Co) acts as a binder and keeps the material together.</p> <p>Carbide materials are often characterised by high compression strength, high hardness and therefore high wear resistance, but also by limited flexural strength and toughness. Carbide is used in taps, reamers, milling cutters, drills and thread milling cutters.</p>
--	---	--

Surface Coatings

Bright Nickel Plating		Bright Nickel Plated surface protects hardened steel body from rust, corrosion and also improves chip evacuation.
Ti-phon (TiAlCrSiN)		Ti-phon Coating is a coating similar to TiAlN but with the addition of Chromium (Cr) and Silicon (Si) which is specially formulated for Hydra Heads to prevent edge build-up and greatly improve chip flow. This coating exhibits high hot hardness, high oxidation resistance and superior lubricity when used on tools for machining applications involving heavy mechanical and thermal stresses, high speeds and high feed rates. These coating properties translate into superior wear resistance and edge strength.



DORMER PRAMET



ALL TOOLS TOGETHER

Our entire assortment of rounds tools and indexables is included within the machining calculator app. That's more than 40,000 items! Whatever your machining we're likely to have something for it.
Simply Reliable.

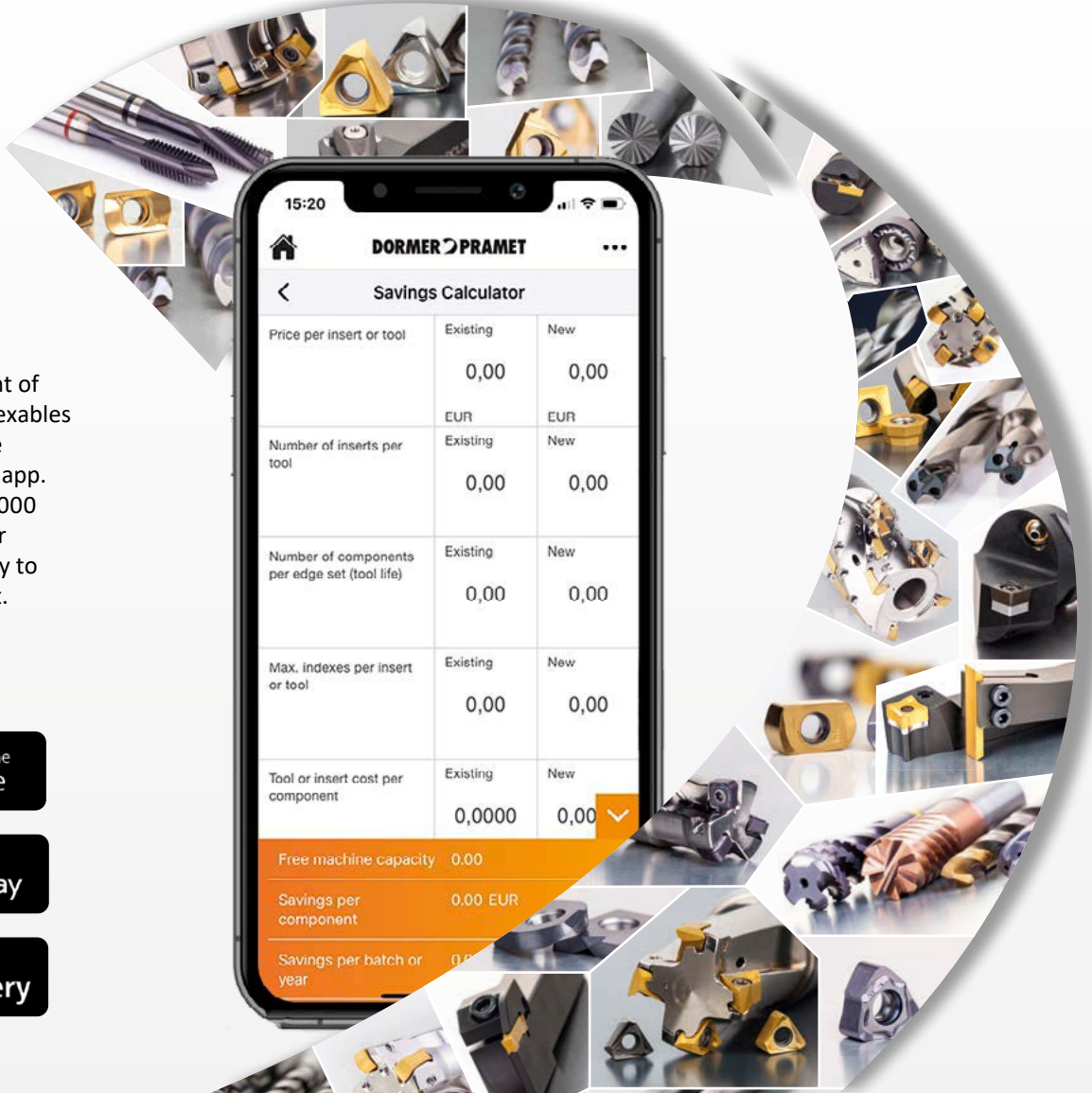

DORMER PRAMET		
Savings Calculator		
Price per insert or tool	Existing 0,00	New 0,00
	EUR	EUR
Number of inserts per tool	Existing 0,00	New 0,00
Number of components per edge set (tool life)	Existing 0,00	New 0,00
Max. indexes per insert or tool	Existing 0,00	New 0,00
Tool or insert cost per component	Existing 0,0000	New 0,00
Free machine capacity	0.00	
Savings per component	0.00 EUR	
Savings per batch or year	0.00	













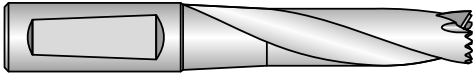













Material code (BMC)	HM	HM	HM	HSS	HSS	HSS	HSS	HSS					
Basic standard group (BSG)	DORMER	DORMER	DORMER	DORMER	DORMER	DORMER	DORMER	DORMER					
Usable length (ULDR)				1.5xD	3xD	5xD	8xD	12xD					
Application angle	140°	140°	140°										
Coating	Ti-phos	Ti-phos	Ti-phos	Bright Ni	Bright Ni	Bright Ni	Bright Ni	Bright Ni					
Shank				ISO 9766	DIN 6535HB DIN 6535HE	DIN 6535HB DIN 6535HE	DIN 6535HB DIN 6535HE	DIN 6535HB DIN 6535HE					
Hand (Cutting direction)	R	R	R	R	R	R	R	R					
Cooling (CSP)													
Product Family Code	R950	R960	R970	H851	H853	H855	H858	H8512	H860	H861			
	12.00 - 42.00, 15/32 - 1.5/8	12.00 - 30.50, 15/32 - 1.3/16	12.00 - 42.00, 15/32 - 1.5/8	12.00 - 30.50, 15/32 - 1.3/16	12.00 - 42.50, 15/32 - 1.5/8	12.00 - 42.50, 15/32 - 1.5/8	13.50 - 42.50, 35/64 - 1.5/8	13.50 - 25.65, 35/64 - 1.1/64	N1 - N7	N1 - N6			
	281	283	285	287	289	291	293	294	295	296			
P	P1	■	■										
	P2	■	■										
	P3	■											
	P4	■											
M	M1		■										
	M2		■										
	M3		■										
	M4		■										
K	K1		■	■									
	K2	■	■	■									
	K3	■	■	■									
	K4	■	■	■									
	K5	■	■	■									
N	N1												
	N2												
	N3												
	N4												
	N5												
S	S1		■										
	S2		■										
	S3		■										
	S4		■										
H	H1												
	H2												
	H3												
	H4												

■ Primary use ■ Possible use



HIGH PERFORMANCE REPLACEABLE HEAD DRILLS

SetUp										
DC	H851 1.5×D	H853 3×D	H855 5×D	H858 8×D	H8512 12×D	R950	R960	R970	H860	H861
										
Range	12.00 – 30.50 15/32" – 1.3/16"	12.00 – 42.50 15/32" – 1.5/8"	12.00 – 42.50 15/32" – 1.5/8"	13.50 – 42.50 35/64" – 1.5/8"	13.50 – 25.65 35/64" – 1.1/64"	12.00 – 42.00 15/32" – 1.5/8"	12.00 – 30.50 15/32" – 1.3/16"	12.00 – 42.00 15/32" – 1.5/8"	N1 – N7	N1 – N6
Pages	 287	 289	 291	 293	 294	 281	 283	 285	 295	 296

DC	H851 1.5×D	H853 3×D	H855 5×D	H858 8×D	H8512 12×D	R950	R960	R970	H860	H861
15/32"						R95015/32	R96015/32	R97015/32		
12.0						R95012.0	R96012.0	R97012.0		
12.1	H85112.0	H85312.0	H85512.0	–	–	R95012.1	R96012.1	R97012.1		
12.2	H85131/64	H85331/64	H85531/64			R95012.2	R96012.2	R97012.2		
31/64"						R95031/64	R96031/64	R97031/64		
12.5						R95012.5	R96012.5	R97012.5		
12.6						R95012.6	R96012.6	R97012.6		
1/2"	H85112.5	H85312.5	H85512.5	–	–	R9501/2	R9601/2	R9701/2		
12.8	H8511/2	H8531/2	H8551/2			R95012.8	R96012.8	R97012.8		
12.9						R95012.9	R96012.9	R97012.9		
13.0						R95013.0	R96013.0	R97013.0		
33/64"						R95033/64	R96033/64	R97033/64		
13.2	H85113.0	H85313.0	H85513.0	–	–	R95013.2	R96013.2	R97013.2		
17/32"	H85117/32	H85317/32	H85517/32			R95017/32	R96017/32	R97017/32		
13.5						R95013.5	R96013.5	R97013.5		
13.6						R95013.6	R96013.6	R97013.6		
13.7						R95013.7	R96013.7	R97013.7		
13.8						R95013.8	R96013.8	R97013.8		
35/64"						R95035/64	R96035/64	R97035/64		
14.0	H85114.0	H85314.0	H85514.0	H85814.0	H851214.0	R95014.0	R96014.0	R97014.0	H860N1	H861N1
14.1	H8519/16	H8539/16	H8559/16			R95014.1	R96014.1	R97014.1		
14.2						R95014.2	R96014.2	R97014.2		
9/16"						R9509/16	R9609/16	R9709/16		
14.5						R95014.5	R96014.5	R97014.5		
14.6						R95014.6	R96014.6	R97014.6		
37/64"						R95037/64	R96037/64	R97037/64		
14.7						R95014.7	R96014.7	R97014.7		
14.8						R95014.8	R96014.8	R97014.8		
15.0						R95015.0	R96015.0	R97015.0		
19/32"						R95019/32	R96019/32	R97019/32		
15.1	H85115.0	H85315.0	H85515.0	H85815.0	H851215.0	R95015.1	R96015.1	R97015.1		
15.2	H85139/64	H85339/64	H85539/64			R95015.2	R96015.2	R97015.2		
15.24						R95015.24	R96015.24	R97015.24		
39/64"						R95039/64	R96039/64	R97039/64		
15.5						R95015.5	R96015.5	R97015.5		



HIGH PERFORMANCE REPLACEABLE HEAD DRILLS

DC	H851 1.5xD	H853 3xD	H855 5xD	H858 8xD	H8512 12xD	R950	R960	R970	H860	H861							
15.6	H85116.0 H85141/64	H85316.0 H85341/64	H85516.0 H85541/64	H85816.0	H851216.0	R95015.6	R96015.6	R97015.6	H860N2	H861N2							
15.7						R95015.7	R96015.7	R97015.7									
5/8"						R9505/8	R9605/8	R9705/8									
16.0						R95016.0	R96016.0	R97016.0									
16.08						R95016.08	R96016.08	R97016.08									
16.1						R95016.1	R96016.1	R97016.1									
16.2						R95016.2	R96016.2	R97016.2									
16.3						R95016.3	R96016.3	R97016.3									
41/64"						R95041/64	R96041/64	R97041/64									
16.5						R95016.5	R96016.5	R97016.5									
16.6	H85117.0 H85111/16	H85317.0 H85311/16	H85517.0 H85511/16	H85817.0	H851217.0	R95016.6	R96016.6	R97016.6	H860N2	H861N2							
21/32"						R95021/32	R96021/32	R97021/32									
16.7						R95016.7	R96016.7	R97016.7									
17.0						R95017.0	R96017.0	R97017.0									
43/64"						R95043/64	R96043/64	R97043/64									
17.1						R95017.1	R96017.1	R97017.1									
17.2						R95017.2	R96017.2	R97017.2									
11/16"						R95011/16	R96011/16	R97011/16									
17.5						R95017.5	R96017.5	R97017.5									
17.6						H85118.0 H85123/32	H85318.0 H85323/32	H85518.0 H85523/32			H85818.0	H851218.0	R95017.6	R96017.6	R97017.6	H860N3	H861N3
17.7	R95017.7	R96017.7	R97017.7														
45/64"	R95045/64	R96045/64	R97045/64														
18.0	R95018.0	R96018.0	R97018.0														
18.1	R95018.1	R96018.1	R97018.1														
18.2	R95018.2	R96018.2	R97018.2														
23/32"	R95023/32	R96023/32	R97023/32														
18.5	R95018.5	R96018.5	R97018.5														
18.6	H85119.0 H85149/64	H85319.0 H85349/64	H85519.0 H85549/64	H85819.0	H851219.0				R95018.6	R96018.6			R97018.6	H860N3	H861N3		
47/64"									R95047/64	R96047/64			R97047/64				
18.7						R95018.7	R96018.7	R97018.7									
18.9						R95018.9	R96018.9	R97018.9									
19.0						R95019.0	R96019.0	R97019.0									
3/4"						R9503/4	R9603/4	R9703/4									
19.1						R95019.1	R96019.1	R97019.1									
19.2						R95019.2	R96019.2	R97019.2									
19.25						R95019.25	R96019.25	R97019.25									
19.3						R95019.3	R96019.3	R97019.3									
19.35	R95019.35	R96019.35	R97019.35														
49/64"	R95049/64	R96049/64	R97049/64														
19.5	R95019.5	R96019.5	R97019.5														
19.6	H85120.0 H85151/64	H85320.0 H85351/64	H85520.0 H85551/64	H85820.0	H851220.0	R95019.6	R96019.6	R97019.6	H860N4	H861N3							
19.7						R95019.7	R96019.7	R97019.7									
25/32"						R95025/32	R96025/32	R97025/32									
20.0						R95020.0	R96020.0	R97020.0									
51/64"						R95051/64	R96051/64	R97051/64									
20.5						R95020.5	R96020.5	R97020.5									
13/16"						R95013/16	R96013/16	R97013/16									
21.0						R95021.0	R96021.0	R97021.0									
53/64"						R95053/64	R96053/64	R97053/64									
27/32"						R95027/32	R96027/32	R97027/32									
21.5	R95021.5	R96021.5	R97021.5														
55/64"	H85122.0 H85157/64	H85322.0 H85357/64	H85522.0 H85557/64	H85822.0	H851222.0	R95055/64	R96055/64	R97055/64	H860N4	H861N3							
22.0						R95022.0	R96022.0	R97022.0									
7/8"						R9507/8	R9607/8	R9707/8									
22.5						R95022.5	R96022.5	R97022.5									
57/64"						R95057/64	R96057/64	R97057/64									
22.7						R95022.7	R96022.7	R97022.7									
23.0	H85123.0 H85159/64	H85323.0 H85359/64	H85523.0 H85559/64	H85823.0	H851223.0	R95023.0	R96023.0	R97023.0	H860N4	H861N3							
29/32"						R95029/32	R96029/32	R97029/32									
59/64"						R95059/64	R96059/64	R97059/64									
23.5						R95023.5	R96023.5	R97023.5									



HIGH PERFORMANCE REPLACEABLE HEAD DRILLS

DC	H851 1.5×D	H853 3×D	H855 5×D	H858 8×D	H8512 12×D	R950	R960	R970	H860	H861
15/16	H85124.0 H85131/32	H85324.0 H85331/32	H85524.0 H85531/32	H85824.0	H851224.0	R95015/16	R96015/16	R97015/16	H860N4	H861N3
24.0						R95024.0	R96024.0	R97024.0		
61/64						R95061/64	R96061/64	R97061/64		
24.5						R95024.5	R96024.5	R97024.5		
31/32"						R95031/32	R96031/32	R97031/32		
25.0	H85125.0 H8511.1/64	H85325.0 H8531.1/64	H85525.0 H8551.1/64	H85825.0	H851225.0	R95025.0	R96025.0	R97025.0	H860N5	H861N4
63/64"						R95063/64	R96063/64	R97063/64		
1"						R9501	R9601	R9701		
25.5						R95025.5	R96025.5	R97025.5		
25.6						R95025.6	–	–		
25.65						R95025.65	R96025.65	R97025.65		
1.1/64"						R9501.1/64	R9601.1/64	R9701.1/64		
26.0						R95026.0	R96026.0	R97026.0		
1.1/32"						R9501.1/32	R9601.1/32	R9701.1/32		
26.5						R95026.5	R96026.5	R97026.5		
1.3/64	R9501.3/64	R9601.3/64	R9701.3/64							
1.1/16"	H85127.0 H8511.3/32	H85327.0 H8531.3/32	H85527.0 H8551.3/32	H85827.0	–	R9501.1/16	R9601.1/16	R9701.1/16	H860N6	H861N5
27.0						R95027.0	R96027.0	R97027.0		
1.5/64"						R9501.5/64	R9601.5/64	R9701.5/64		
27.5						R95027.5	R96027.5	R97027.5		
1.3/32"						R9501.3/32	R9601.3/32	R9701.3/32		
28.0	H85128.0 H8511.1/8	H85328.0 H8531.1/8	H85528.0 H8551.1/8	H85828.0	–	R95028.0	R96028.0	R97028.0	H860N7	H861N6
1.7/64"						R9501.7/64	R9601.7/64	R9701.7/64		
28.5						R95028.5	R96028.5	R97028.5		
1.1/8"						R9501.1/8	R9601.1/8	R9701.1/8		
1.9/64"						R9501.9/64	R9601.9/64	R9701.9/64		
29.0	H85129.0 H8511.11/64	H85329.0 H8531.11/64	H85529.0 H8551.11/64	H85829.0	–	R95029.0	R96029.0	R97029.0	H860N8	H861N7
1.5/32"						R9501.5/32	R9601.5/32	R9701.5/32		
29.5						R95029.5	R96029.5	R97029.5		
1.11/64"						R9501.11/64	R9601.11/64	R9701.11/64		
30.0						R95030.0	R96030.0	R97030.0		
1.3/16"	H85130.0 H8511.3/16	H85330.0 H8531.3/16	H85530.0 H8551.3/16	H85830.0	–	R9501.3/16	R9601.3/16	R9701.3/16	H860N9	H861N8
30.5						R95030.5	R96030.5	R97030.5		
1.7/32"						R9501.7/32	–	R9701.7/32		
31.0						R95031.0	–	R97031.0		
1.1/4"						R9501.1/4	–	R9701.1/4		
32.0	R95032.0	–	R97032.0							
32.5	–	H85332.0	H85532.0	H85832.0	–	R95032.5	–	R97032.5	H860N10	H861N9
1.19/64"						R9501.19/64	–	R9701.19/64		
33.0						R95033.0	–	R97033.0		
33.5						R95033.5	–	R97033.5		
34.0						R95034.0	–	R97034.0		
1.11/32"	–	H85333.5	H85533.5	H85833.5	–	R9501.11/32	–	R9701.11/32	H860N11	H861N10
34.5						R95034.5	–	R97034.5		
1.3/8"						R9501.3/8	–	R9701.3/8		
35.0						R95035.0	–	R97035.0		
36.0						R95036.0	–	R97036.0		
1.27/64"	–	H85334.0	H85534.0	H85834.0	–	R9501.27/64	–	R9701.27/64	H860N12	H861N11
36.5						R95036.5	–	R97036.5		
37.0						R95037.0	–	R97037.0		
1.15/32"						R9501.15/32	–	R9701.15/32		
37.5						R95037.5	–	R97037.5		
38.0	R95038.0	–	R97038.0							
1.1/2"	–	H85335.0	H85535.0	H85835.0	–	R9501.1/2	–	R9701.1/2	H860N13	H861N12
38.5						R95038.5	–	R97038.5		
1.17/32"						R9501.17/32	–	R9701.17/32		
39.0						R95039.0	–	R97039.0		
39.5						R95039.5	–	R97039.5		
1.9/16"	–	H85336.5	H85536.5	H85836.5	–	R9501.9/16	–	R9701.9/16	H860N14	H861N13
40.0						R95040.0	–	R97040.0		
41.0						R95041.0	–	R97041.0		



HIGH PERFORMANCE REPLACEABLE HEAD DRILLS

DC	H851 1.5×D	H853 3×D	H855 5×D	H858 8×D	H8512 12×D	R950	R960	R970	H860	H861
1.5/8"	–	H85342.5	H85542.5	H85842.5	–	R9501.5/8	–	R9701.5/8	H860N7	H861N6
42.0						R95042.0	–	R97042.0		

Accessories

H860	H861	Hydra Head DC range			Wrench Size / Bit
		Metric (min. – max.)	Fractional (min. – max.)	Decimal (min. – max.)	
H860N1	H861N1	12.0 mm – 15.5 mm	15/32" – 39/64"	0.4688" – 0.6102"	8IP
H860N2	H861N2	15.6 mm – 18.5 mm	5/8" – 23/32"	0.6142" – 0.7283"	10IP
H860N3	H861N3	18.6 mm – 21.5 mm	47/64" – 27/32"	0.7323" – 0.8465"	15IP
H860N4	H861N3	22.0 mm – 24.5 mm	55/64" – 31/32"	0.8594" – 0.9688"	15IP
H860N5	H861N4	25.0 mm – 27.5 mm	63/64" – 1-3/32"	0.9843" – 1.0938"	20IP
H860N6	H861N5	28.0 mm – 33.5 mm	1-7/64" – 1-19/64"	1.1024" – 1.3189"	25IP
H860N7	H861N6	34.0 mm – 42.0 mm	1-11/32" – 1-5/8"	1.3386" – 1.6535"	4 mm



R950

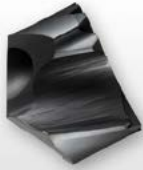

HYDRA Drill Head for Steels, Ti-phong Coated

Highly cost-effective and accurate design replaceable head for high performance in steels and harder materials. A 140° split point helps with self-centering and reduces cutting forces. Ti-phong coating prevents edge build-up and greatly improves chip flow, with superior wear resistance and edge strength.

HYDRA

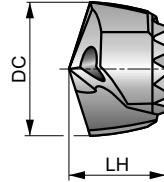

HM	DORMER	140°
Ti-phong	R	
DC h7		

H851	Apply starting values for speed and feed with a correction factor of 1.10
H853	Apply starting values for speed and feed with a correction factor of 1.00
H855	Apply starting values for speed and feed with a correction factor of 0.95
H858	Apply starting values for speed and feed with a correction factor of 0.90
H8512	Apply starting values for speed and feed with a correction factor of 0.80

Workpiece material group suitability, starting values for cutting speed (m/min) and feed Alpha Code.

P1.1 ■ 133 W	P1.2 ■ 148 W	P1.3 ■ 154 W	P2.1 ■ 114 W	P2.2 ■ 100 W	P2.3 ■ 88 W	P3.1 ■ 125 W	P3.2 ■ 101 W	P3.3 ■ 85 W	P4.1 ■ 75 W	P4.2 ■ 63 W	P4.3 ■ 52 T	M2.3 ■ 41 T	M4.2 ■ 35 T
K2.1 ■ 108 V	K2.2 ■ 88 V	K2.3 ■ 70 V	K3.1 ■ 96 V	K3.2 ■ 73 V	K3.3 ■ 59 V	K4.1 ■ 89 V	K4.2 ■ 67 V	K4.3 ■ 49 V	K4.4 ■ 42 V	K4.5 ■ 35 V	K5.1 ■ 100 V	K5.2 ■ 76 V	K5.3 ■ 58 V

Product	DC	DC	DC	LH
	[inch]	[mm]	[inch]	[mm]
R95015/32	15/32	11.91	0.4688	9.1
R95012.0	—	12.00	0.4724	9.1
R95012.1	—	12.10	0.4764	9.1
R95012.2	—	12.20	0.4803	9.1
R95031/64	31/64	12.30	0.4844	9.1
R95012.5	—	12.50	0.4921	9.4
R95012.6	—	12.60	0.4961	9.4
R9501/2	1/2	12.70	0.5000	9.4
R95012.8	—	12.80	0.5039	9.4
R95012.9	—	12.90	0.5079	9.4
R95013.0	—	13.00	0.5118	9.7
R95033/64	33/64	13.10	0.5156	9.7
R95013.2	—	13.20	0.5197	9.7
R95017/32	17/32	13.49	0.5313	9.7
R95013.5	—	13.50	0.5315	10.3
R95013.6	—	13.60	0.5354	10.3
R95013.7	—	13.70	0.5394	10.3
R95013.8	—	13.80	0.5433	10.3
R95035/64	35/64	13.89	0.5469	10.3
R95014.0	—	14.00	0.5512	10.3
R95014.1	—	14.10	0.5551	10.3
R95014.2	—	14.20	0.5591	10.3
R9509/16	9/16	14.29	0.5625	10.3
R95014.5	—	14.50	0.5709	10.3
R95014.6	—	14.60	0.5748	11.0
R95037/64	37/64	14.68	0.5781	11.0
R95014.7	—	14.70	0.5787	11.0
R95014.8	—	14.80	0.5827	11.0
R95015.0	—	15.00	0.5906	11.0
R95019/32	19/32	15.08	0.5938	11.0

Product	DC	DC	DC	LH
	[inch]	[mm]	[inch]	[mm]
R95015.1	—	15.10	0.5945	11.0
R95015.2	—	15.20	0.5984	11.0
R95015.24	—	15.24	0.6000	11.0
R95039/64	39/64	15.48	0.6094	11.0
R95015.5	—	15.50	0.6102	11.0
R95015.6	—	15.60	0.6142	11.6
R95015.7	—	15.70	0.6181	11.6
R9505/8	5/8	15.88	0.6250	11.6
R95016.0	—	16.00	0.6299	11.6
R95016.08	—	16.08	0.6331	11.6
R95016.1	—	16.10	0.6339	11.6
R95016.2	—	16.20	0.6378	11.6
R95041/64	41/64	16.27	0.6406	11.6
R95016.3	—	16.30	0.6417	11.6
R95016.5	—	16.50	0.6496	11.6
R95016.6	—	16.60	0.6535	12.2
R95021/32	21/32	16.67	0.6563	12.2
R95016.7	—	16.70	0.6575	12.2
R95017.0	—	17.00	0.6693	12.2
R95043/64	43/64	17.07	0.6719	12.2
R95017.1	—	17.10	0.6732	12.2
R95017.2	—	17.20	0.6772	12.2
R95011/16	11/16	17.46	0.6875	12.2
R95017.5	—	17.50	0.6890	12.2
R95017.6	—	17.60	0.6929	12.9
R95017.7	—	17.70	0.6969	12.9
R95045/64	45/64	17.86	0.7031	12.9
R95018.0	—	18.00	0.7087	12.9
R95018.1	—	18.10	0.7126	12.9
R95018.2	—	18.20	0.7165	12.9



Product	DC	DC	DC	LH
	[inch]	[mm]	[inch]	[mm]
R95023/32	23/32	18.26	0.7188	12.9
R95018.5	–	18.50	0.7283	12.9
R95018.6	–	18.60	0.7323	13.5
R95047/64	47/64	18.65	0.7344	13.5
R95018.7	–	18.70	0.7362	13.5
R95018.9	–	18.90	0.7441	13.5
R95019.0	–	19.00	0.7480	13.5
R9503/4	3/4	19.05	0.7500	13.5
R95019.1	–	19.10	0.7520	13.5
R95019.2	–	19.20	0.7559	13.5
R95019.25	–	19.25	0.7579	13.5
R95019.3	–	19.30	0.7598	13.5
R95019.35	–	19.35	0.7618	13.5
R95049/64	49/64	19.45	0.7656	13.5
R95019.5	–	19.50	0.7677	13.5
R95019.6	–	19.60	0.7717	14.1
R95019.7	–	19.70	0.7756	14.1
R95025/32	25/32	19.84	0.7813	14.1
R95020.0	–	20.00	0.7874	14.1
R95051/64	51/64	20.24	0.7969	14.1
R95020.5	–	20.50	0.8071	14.1
R95013/16	13/16	20.64	0.8125	14.8
R95021.0	–	21.00	0.8268	14.8
R95053/64	53/64	21.03	0.8281	14.8
R95027/32	27/32	21.43	0.8438	14.8
R95021.5	–	21.50	0.8465	14.8
R95055/64	55/64	21.83	0.8594	15.0
R95022.0	–	22.00	0.8661	15.0
R9507/8	7/8	22.22	0.8750	15.0
R95022.5	–	22.50	0.8858	15.0
R95057/64	57/64	22.62	0.8906	15.0
R95022.7	–	22.70	0.8937	15.0
R95023.0	–	23.00	0.9055	15.1
R95029/32	29/32	23.02	0.9063	15.1
R95059/64	59/64	23.42	0.9219	15.1
R95023.5	–	23.50	0.9252	15.1
R95015/16	15/16	23.81	0.9375	15.4
R95024.0	–	24.00	0.9449	15.4
R95061/64	61/64	24.21	0.9531	15.4
R95024.5	–	24.50	0.9646	15.4
R95031/32	31/32	24.61	0.9688	15.4
R95025.0	–	25.00	0.9844	15.8
R95063/64	63/64	25.00	0.9844	15.8
R9501	1"	25.40	1.0000	15.8
R95025.5	–	25.50	1.0039	15.8
R95025.6	–	25.60	1.0079	15.8
R95025.65	–	25.65	1.0098	15.8
R9501.1/64	1.1/64	25.80	1.0156	15.8
R95026.0	–	26.00	1.0236	16.4
R9501.1/32	1.1/32	26.19	1.0313	16.4

Product	DC	DC	DC	LH
	[inch]	[mm]	[inch]	[mm]
R95026.5	–	26.50	1.0433	16.4
R9501.3/64	1.3/64	26.59	1.0469	16.4
R9501.1/16	1.1/16	26.99	1.0625	17.1
R95027.0	–	27.00	1.0630	17.1
R9501.5/64	1.5/64	27.38	1.0781	17.1
R95027.5	–	27.50	1.0827	17.1
R9501.3/32	1.3/32	27.78	1.0938	17.1
R95028.0	–	28.00	1.1024	17.7
R9501.7/64	1.7/64	28.18	1.1094	17.7
R95028.5	–	28.50	1.1220	17.7
R9501.1/8	1.1/8	28.58	1.1250	17.7
R9501.9/64	1.9/64	28.97	1.1406	18.3
R95029.0	–	29.00	1.1417	18.3
R9501.5/32	1.5/32	29.37	1.1563	18.3
R95029.5	–	29.50	1.1614	18.3
R9501.11/64	1.11/64	29.77	1.1719	18.3
R95030.0	–	30.00	1.1811	19.0
R9501.3/16	1.3/16	30.16	1.1875	19.0
R95030.5	–	30.50	1.2008	19.0
R9501.7/32	1.7/32	30.96	1.2188	21.0
R95031.0	–	31.00	1.2205	21.0
R9501.1/4	1.1/4	31.75	1.2500	21.0
R95032.0	–	32.00	1.2598	21.0
R95032.5	–	32.50	1.2795	21.0
R9501.19/64	1.19/64	32.94	1.2969	21.0
R95033.0	–	33.00	1.2992	21.0
R95033.5	–	33.50	1.3189	21.0
R95034.0	–	34.00	1.3386	23.0
R9501.11/32	1.11/32	34.13	1.3438	23.0
R95034.5	–	34.50	1.3583	23.0
R9501.3/8	1.3/8	34.93	1.3750	23.0
R95035.0	–	35.00	1.3780	23.0
R95036.0	–	36.00	1.4173	23.0
R9501.27/64	1.27/64	36.12	1.4219	23.0
R95036.5	–	36.50	1.4370	23.0
R95037.0	–	37.00	1.4567	25.0
R9501.15/32	1.15/32	37.31	1.4688	25.0
R95037.5	–	37.50	1.4764	25.0
R95038.0	–	38.00	1.4961	25.0
R9501.1/2	1.1/2	38.10	1.5000	25.0
R95038.5	–	38.50	1.5157	25.0
R9501.17/32	1.17/32	38.89	1.5313	25.0
R95039.0	–	39.00	1.5354	25.0
R95039.5	–	39.50	1.5551	25.0
R9501.9/16	1.9/16	39.69	1.5625	27.0
R95040.0	–	40.00	1.5748	27.0
R95041.0	–	41.00	1.6142	27.0
R9501.5/8	1.5/8	41.28	1.6250	27.0
R95042.0	–	42.00	1.6535	27.0



R960

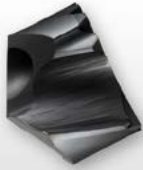

HYDRA Drill Head for Stainless Steels, Ti-phon Coated

Highly cost-effective and accurate design replaceable head for high performance in stainless steels. A 140° split point helps with self-centering and reduces cutting forces. Ti-phon coating prevents edge build-up and greatly improves chip flow, with superior wear resistance and edge strength.

HYDRA

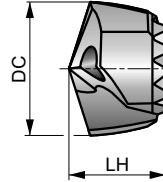

HM	DORMER	140°
Ti-phon	R	
DC h7		

H851	Apply starting values for speed and feed with a correction factor of 1.10
H853	Apply starting values for speed and feed with a correction factor of 1.00
H855	Apply starting values for speed and feed with a correction factor of 0.95
H858	Apply starting values for speed and feed with a correction factor of 0.90
H8512	Apply starting values for speed and feed with a correction factor of 0.80

Workpiece material group suitability, starting values for cutting speed (m/min) and feed Alpha Code.

P1.1 ■ 133 W	P1.2 ■ 148 W	P1.3 ■ 154 W	P2.1 ■ 114 W	M1.1 ■ 82 V	M1.2 ■ 70 V	M2.1 ■ 73 V	M2.2 ■ 60 V	M2.3 ▣ 50 T	M3.1 ■ 58 T	M3.2 ■ 50 T	M3.3 ■ 45 T	M4.1 ■ 40 T	M4.2 ▣ 34 T
K1.1 ■ 120 V	K1.2 ■ 89 V	K1.3 ■ 67 V	K2.1 ▣ 108 V	K2.2 ▣ 88 V	K2.3 ▣ 70 V	K3.1 ▣ 96 V	K3.2 ▣ 73 V	K3.3 ▣ 59 V	K4.1 ▣ 89 V	K4.2 ▣ 67 V	K4.3 ▣ 49 V	K4.4 ▣ 42 V	K4.5 ▣ 35 V
K5.1 ▣ 100 V	K5.2 ▣ 76 V	K5.3 ▣ 58 V	S1.1 ▣ 45 T	S1.2 ▣ 35 T	S1.3 ▣ 30 S	S2.1 ▣ 40 S	S2.2 ▣ 35 S	S3.1 ▣ 30 S	S3.2 ▣ 25 S	S4.1 ▣ 23 S	S4.2 ▣ 20 S		

Product	DC	DC	DC	LH
	[inch]	[mm]	[inch]	[mm]
R96015/32	15/32	11.91	0.4688	9.1
R96012.0	–	12.00	0.4724	9.1
R96012.1	–	12.10	0.4764	9.1
R96012.2	–	12.20	0.4803	9.1
R96031/64	31/64	12.30	0.4844	9.1
R96012.5	–	12.50	0.4921	9.4
R96012.6	–	12.60	0.4961	9.4
R9601/2	1/2	12.70	0.5000	9.4
R96012.8	–	12.80	0.5039	9.4
R96012.9	–	12.90	0.5079	9.4
R96013.0	–	13.00	0.5118	9.7
R96033/64	33/64	13.10	0.5156	9.7
R96013.2	–	13.20	0.5197	9.7
R96017/32	17/32	13.49	0.5313	9.7
R96013.5	–	13.50	0.5315	10.3
R96013.6	–	13.60	0.5354	10.3
R96013.7	–	13.70	0.5394	10.3
R96013.8	–	13.80	0.5433	10.3
R96035/64	35/64	13.89	0.5469	10.3
R96014.0	–	14.00	0.5512	10.3
R96014.1	–	14.10	0.5551	10.3
R96014.2	–	14.20	0.5591	10.3
R9609/16	9/16	14.29	0.5625	10.3
R96014.5	–	14.50	0.5709	10.3
R96014.6	–	14.60	0.5748	11.0
R96037/64	37/64	14.68	0.5781	11.0
R96014.7	–	14.70	0.5787	11.0
R96014.8	–	14.80	0.5827	11.0

Product	DC	DC	DC	LH
	[inch]	[mm]	[inch]	[mm]
R96015.0	–	15.00	0.5906	11.0
R96019/32	19/32	15.08	0.5938	11.0
R96015.1	–	15.10	0.5945	11.0
R96015.2	–	15.20	0.5984	11.0
R96015.24	–	15.24	0.6000	11.0
R96039/64	39/64	15.48	0.6094	11.0
R96015.5	–	15.50	0.6102	11.0
R96015.6	–	15.60	0.6142	11.6
R96015.7	–	15.70	0.6181	11.6
R9605/8	5/8	15.88	0.6250	11.6
R96016.0	–	16.00	0.6299	11.6
R96016.08	–	16.08	0.6331	11.6
R96016.1	–	16.10	0.6339	11.6
R96016.2	–	16.20	0.6378	11.6
R96041/64	41/64	16.27	0.6406	11.6
R96016.3	–	16.30	0.6417	11.6
R96016.5	–	16.50	0.6496	11.6
R96016.6	–	16.60	0.6535	12.2
R96021/32	21/32	16.67	0.6563	12.2
R96016.7	–	16.70	0.6575	12.2
R96017.0	–	17.00	0.6693	12.2
R96043/64	43/64	17.07	0.6719	12.2
R96017.1	–	17.10	0.6732	12.2
R96017.2	–	17.20	0.6772	12.2
R96011/16	11/16	17.46	0.6875	12.2
R96017.5	–	17.50	0.6890	12.2
R96017.6	–	17.60	0.6929	12.9
R96017.7	–	17.70	0.6969	12.9



Product	DC	DC	DC	LH
	[inch]	[mm]	[inch]	[mm]
R96045/64	45/64	17.86	0.7031	12.9
R96018.0	–	18.00	0.7087	12.9
R96018.1	–	18.10	0.7126	12.9
R96018.2	–	18.20	0.7165	12.9
R96023/32	23/32	18.26	0.7188	12.9
R96018.5	–	18.50	0.7283	12.9
R96018.6	–	18.60	0.7323	13.5
R96047/64	47/64	18.65	0.7344	13.5
R96018.7	–	18.70	0.7362	13.5
R96018.9	–	18.90	0.7441	13.5
R96019.0	–	19.00	0.7480	13.5
R9603/4	3/4	19.05	0.7500	13.5
R96019.1	–	19.10	0.7520	13.5
R96019.2	–	19.20	0.7559	13.5
R96019.25	–	19.25	0.7579	13.5
R96019.3	–	19.30	0.7598	13.5
R96019.35	–	19.35	0.7618	13.5
R96049/64	49/64	19.45	0.7656	13.5
R96019.5	–	19.50	0.7677	13.5
R96019.6	–	19.60	0.7717	14.1
R96019.7	–	19.70	0.7756	14.1
R96025/32	25/32	19.84	0.7813	14.1
R96020.0	–	20.00	0.7874	14.1
R96051/64	51/64	20.24	0.7969	14.1
R96020.5	–	20.50	0.8071	14.1
R96013/16	13/16	20.64	0.8125	14.8
R96021.0	–	21.00	0.8268	14.8
R96053/64	53/64	21.03	0.8281	14.8
R96027/32	27/32	21.43	0.8438	14.8
R96021.5	–	21.50	0.8465	14.8
R96055/64	55/64	21.83	0.8594	15.0
R96022.0	–	22.00	0.8661	15.0
R9607/8	7/8	22.22	0.8750	15.0
R96022.5	–	22.50	0.8858	15.0
R96057/64	57/64	22.62	0.8906	15.0
R96022.7	–	22.70	0.8937	15.0

Product	DC	DC	DC	LH
	[inch]	[mm]	[inch]	[mm]
R96023.0	–	23.00	0.9055	15.1
R96029/32	29/32	23.02	0.9063	15.1
R96059/64	59/64	23.42	0.9219	15.1
R96023.5	–	23.50	0.9252	15.1
R96015/16	15/16	23.81	0.9375	15.4
R96024.0	–	24.00	0.9449	15.4
R96061/64	61/64	24.21	0.9531	15.4
R96024.5	–	24.50	0.9646	15.4
R96031/32	31/32	24.61	0.9688	15.4
R96025.0	–	25.00	0.9844	15.8
R96063/64	63/64	25.00	0.9844	15.8
R9601	1"	25.40	1.0000	15.8
R96025.5	–	25.50	1.0039	15.8
R96025.65	–	25.65	1.0098	15.8
R9601.1/64	1.1/64	25.80	1.0156	15.8
R96026.0	–	26.00	1.0236	16.4
R9601.1/32	1.1/32	26.19	1.0313	16.4
R96026.5	–	26.50	1.0433	16.4
R9601.3/64	1.3/64	26.59	1.0469	16.4
R9601.1/16	1.1/16	26.99	1.0625	17.1
R96027.0	–	27.00	1.0630	17.1
R9601.5/64	1.5/64	27.38	1.0781	17.1
R96027.5	–	27.50	1.0827	17.1
R9601.3/32	1.3/32	27.78	1.0938	17.1
R96028.0	–	28.00	1.1024	17.7
R9601.7/64	1.7/64	28.18	1.1094	17.7
R96028.5	–	28.50	1.1220	17.7
R9601.1/8	1.1/8	28.58	1.1250	17.7
R9601.9/64	1.9/64	28.97	1.1406	18.3
R96029.0	–	29.00	1.1417	18.3
R9601.5/32	1.5/32	29.37	1.1563	18.3
R96029.5	–	29.50	1.1614	18.3
R9601.11/64	1.11/64	29.77	1.1719	18.3
R96030.0	–	30.00	1.1811	19.0
R9601.3/16	1.3/16	30.16	1.1875	19.0
R96030.5	–	30.50	1.2008	19.0



R970



HYDRA Drill Head for Cast Irons, Ti-phon Coated

Highly cost-effective and accurate design replaceable head for high performance in cast irons. A 140° split point helps with self-centering and reduces cutting forces. Ti-phon coating prevents edge build-up and greatly improves chip flow, with superior wear resistance and edge strength.

HYDRA

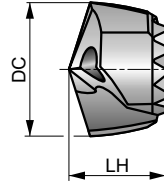

HM	DORMER	140°
Ti-phon	R	
DC h7		

H851	Apply starting values for speed and feed with a correction factor of 1.10
H853	Apply starting values for speed and feed with a correction factor of 1.00
H855	Apply starting values for speed and feed with a correction factor of 0.95
H858	Apply starting values for speed and feed with a correction factor of 0.90
H8512	Apply starting values for speed and feed with a correction factor of 0.80

Workpiece material group suitability, starting values for cutting speed (m/min) and feed Alpha Code.

K1.1 ■ 120 V	K1.2 ■ 89 V	K1.3 ■ 67 V	K2.1 ■ 98 V	K2.2 ■ 80 V	K2.3 ■ 64 V	K3.1 ■ 97 V	K3.2 ■ 67 V	K3.3 ■ 54 V	K4.1 ■ 81 V	K4.2 ■ 61 V	K4.3 ■ 45 V	K4.4 ■ 38 V	K4.5 ■ 32 V
K5.1 ■ 91 V	K5.2 ■ 69 V	K5.3 ■ 53 V											

Product	DC	DC	DC	LH
	[inch]	[mm]	[inch]	[mm]
R97015/32	15/32	11.91	0.4688	9.1
R97012.0	–	12.00	0.4724	9.1
R97012.1	–	12.10	0.4764	9.1
R97012.2	–	12.20	0.4803	9.1
R97031/64	31/64	12.30	0.4844	9.1
R97012.5	–	12.50	0.4921	9.4
R97012.6	–	12.60	0.4961	9.4
R9701/2	1/2	12.70	0.5000	9.4
R97012.8	–	12.80	0.5039	9.4
R97012.9	–	12.90	0.5079	9.4
R97013.0	–	13.00	0.5118	9.7
R97033/64	33/64	13.10	0.5156	9.7
R97013.2	–	13.20	0.5197	9.7
R97017/32	17/32	13.49	0.5313	9.7
R97013.5	–	13.50	0.5315	10.3
R97013.6	–	13.60	0.5354	10.3
R97013.7	–	13.70	0.5394	10.3
R97013.8	–	13.80	0.5433	10.3
R97035/64	35/64	13.89	0.5469	10.3
R97014.0	–	14.00	0.5512	10.3
R97014.1	–	14.10	0.5551	10.3
R97014.2	–	14.20	0.5591	10.3
R9709/16	9/16	14.29	0.5625	10.3
R97014.5	–	14.50	0.5709	10.3
R97014.6	–	14.60	0.5748	11.0
R97037/64	37/64	14.68	0.5781	11.0
R97014.7	–	14.70	0.5787	11.0
R97014.8	–	14.80	0.5827	11.0
R97015.0	–	15.00	0.5906	11.0
R97019/32	19/32	15.08	0.5938	11.0

Product	DC	DC	DC	LH
	[inch]	[mm]	[inch]	[mm]
R97015.1	–	15.10	0.5945	11.0
R97015.2	–	15.20	0.5984	11.0
R97015.24	–	15.24	0.6000	11.0
R97039/64	39/64	15.48	0.6094	11.0
R97015.5	–	15.50	0.6102	11.0
R97015.6	–	15.60	0.6142	11.6
R97015.7	–	15.70	0.6181	11.6
R9705/8	5/8	15.88	0.6250	11.6
R97016.0	–	16.00	0.6299	11.6
R97016.08	–	16.08	0.6331	11.6
R97016.1	–	16.10	0.6339	11.6
R97016.2	–	16.20	0.6378	11.6
R97041/64	41/64	16.27	0.6406	11.6
R97016.3	–	16.30	0.6417	11.6
R97016.5	–	16.50	0.6496	11.6
R97016.6	–	16.60	0.6535	12.2
R97021/32	21/32	16.67	0.6563	12.2
R97016.7	–	16.70	0.6575	12.2
R97017.0	–	17.00	0.6693	12.2
R97043/64	43/64	17.07	0.6719	12.2
R97017.1	–	17.10	0.6732	12.2
R97017.2	–	17.20	0.6772	12.2
R97011/16	11/16	17.46	0.6875	12.2
R97017.5	–	17.50	0.6890	12.2
R97017.6	–	17.60	0.6929	12.9
R97017.7	–	17.70	0.6969	12.9
R97045/64	45/64	17.86	0.7031	12.9
R97018.0	–	18.00	0.7087	12.9
R97018.1	–	18.10	0.7126	12.9
R97018.2	–	18.20	0.7165	12.9



Product	DC	DC	DC	LH
	[inch]	[mm]	[inch]	[mm]
R97023/32	23/32	18.26	0.7188	12.9
R97018.5	–	18.50	0.7283	12.9
R97018.6	–	18.60	0.7323	13.5
R97047/64	47/64	18.65	0.7344	13.5
R97018.7	–	18.70	0.7362	13.5
R97018.9	–	18.90	0.7441	13.5
R97019.0	–	19.00	0.7480	13.5
R9703/4	3/4	19.05	0.7500	13.5
R97019.1	–	19.10	0.7520	13.5
R97019.2	–	19.20	0.7559	13.5
R97019.25	–	19.25	0.7579	13.5
R97019.3	–	19.30	0.7598	13.5
R97019.35	–	19.35	0.7618	13.5
R97049/64	49/64	19.45	0.7656	13.5
R97019.5	–	19.50	0.7677	13.5
R97019.6	–	19.60	0.7717	14.1
R97019.7	–	19.70	0.7756	14.1
R97025/32	25/32	19.84	0.7813	14.1
R97020.0	–	20.00	0.7874	14.1
R97051/64	51/64	20.24	0.7969	14.1
R97020.5	–	20.50	0.8071	14.1
R97013/16	13/16	20.64	0.8125	14.8
R97021.0	–	21.00	0.8268	14.8
R97053/64	53/64	21.03	0.8281	14.8
R97027/32	27/32	21.43	0.8438	14.8
R97021.5	–	21.50	0.8465	14.8
R97055/64	55/64	21.83	0.8594	15.0
R97022.0	–	22.00	0.8661	15.0
R9707/8	7/8	22.22	0.8750	15.0
R97022.5	–	22.50	0.8858	15.0
R97057/64	57/64	22.62	0.8906	15.0
R97022.7	–	22.70	0.8937	15.0
R97023.0	–	23.00	0.9055	15.1
R97029/32	29/32	23.02	0.9063	15.1
R97059/64	59/64	23.42	0.9219	15.1
R97023.5	–	23.50	0.9252	15.1
R97015/16	15/16	23.81	0.9375	15.4
R97024.0	–	24.00	0.9449	15.4
R97061/64	61/64	24.21	0.9531	15.4
R97024.5	–	24.50	0.9646	15.4
R97031/32	31/32	24.61	0.9688	15.4
R97025.0	–	25.00	0.9844	15.8
R97063/64	63/64	25.00	0.9844	15.8
R9701	1"	25.40	1.0000	15.8
R97025.5	–	25.50	1.0039	15.8
R97025.65	–	25.65	1.0098	15.8
R9701.1/64	1.1/64	25.80	1.0156	15.8
R97026.0	–	26.00	1.0236	16.4
R9701.1/32	1.1/32	26.19	1.0313	16.4

Product	DC	DC	DC	LH
	[inch]	[mm]	[inch]	[mm]
R97026.5	–	26.50	1.0433	16.4
R9701.3/64	1.3/64	26.59	1.0469	16.4
R9701.1/16	1.1/16	26.99	1.0625	17.1
R97027.0	–	27.00	1.0630	17.1
R9701.5/64	1.5/64	27.38	1.0781	17.1
R97027.5	–	27.50	1.0827	17.1
R9701.3/32	1.3/32	27.78	1.0938	17.1
R97028.0	–	28.00	1.1024	17.7
R9701.7/64	1.7/64	28.18	1.1094	17.7
R97028.5	–	28.50	1.1220	17.7
R9701.1/8	1.1/8	28.58	1.1250	17.7
R9701.9/64	1.9/64	28.97	1.1406	18.3
R97029.0	–	29.00	1.1417	18.3
R9701.5/32	1.5/32	29.37	1.1563	18.3
R97029.5	–	29.50	1.1614	18.3
R9701.11/64	1.11/64	29.77	1.1719	18.3
R97030.0	–	30.00	1.1811	19.0
R9701.3/16	1.3/16	30.16	1.1875	19.0
R97030.5	–	30.50	1.2008	19.0
R9701.7/32	1.7/32	30.96	1.2188	21.0
R97031.0	–	31.00	1.2205	21.0
R9701.1/4	1.1/4	31.75	1.2500	21.0
R97032.0	–	32.00	1.2598	21.0
R97032.5	–	32.50	1.2795	21.0
R9701.19/64	1.19/64	32.94	1.2969	21.0
R97033.0	–	33.00	1.2992	21.0
R97033.5	–	33.50	1.3189	21.0
R97034.0	–	34.00	1.3386	23.0
R9701.11/32	1.11/32	34.13	1.3438	23.0
R97034.5	–	34.50	1.3583	23.0
R9701.3/8	1.3/8	34.93	1.3750	23.0
R97035.0	–	35.00	1.3780	23.0
R97036.0	–	36.00	1.4173	23.0
R9701.27/64	1.27/64	36.12	1.4219	23.0
R97036.5	–	36.50	1.4370	23.0
R97037.0	–	37.00	1.4567	25.0
R9701.15/32	1.15/32	37.31	1.4688	25.0
R97037.5	–	37.50	1.4764	25.0
R97038.0	–	38.00	1.4961	25.0
R9701.1/2	1.1/2	38.10	1.5000	25.0
R97038.5	–	38.50	1.5157	25.0
R9701.17/32	1.17/32	38.89	1.5313	25.0
R97039.0	–	39.00	1.5354	25.0
R97039.5	–	39.50	1.5551	25.0
R9701.9/16	1.9/16	39.69	1.5625	27.0
R97040.0	–	40.00	1.5748	27.0
R97041.0	–	41.00	1.6142	27.0
R9701.5/8	1.5/8	41.28	1.6250	27.0
R97042.0	–	42.00	1.6535	27.0



H851



HYDRA Body 1.5XD, with Coolant Feed, Bright Nickel Plating

Used with R950, R960 and R970 HYDRA heads. A range of head diameters can be used with the same body. Coolant holes aligned with the heads offer efficient cooling. Flanged shank prevents the drill from wandering in the holder. Nickel Plated surface protects from rust and corrosion, and improves chip evacuation.

HYDRA

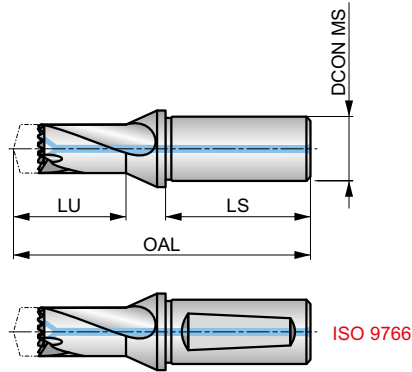

HSS	DORMER	1.5×D
Bright Ni	ISO 9766	R

Four (4) screws and one (1) screwdriver are included with a drill body, DCON MS tolerance h6.

Product	DCONMS	DCON MS	LU	OAL	LS	ADINTMS
	[inch]	[mm]	[mm]	[mm]	[mm]	
H85131/64	5/8	15.88	25.50	88.5	47.6	Cylindrical
H8511/2	5/8	15.88	25.80	88.8	47.6	Cylindrical
H85117/32	5/8	15.88	30.90	93.9	47.6	Cylindrical
H85112.0	–	16.00	25.50	88.5	48.0	ISO 9766
H85112.5	–	16.00	25.80	88.8	48.0	ISO 9766
H85113.0	–	16.00	27.00	90.0	48.0	ISO 9766
H85114.0	–	16.00	30.90	93.9	48.0	ISO 9766
H8519/16	3/4	19.05	30.30	93.9	50.8	Cylindrical
H85139/64	3/4	19.05	32.30	97.3	50.8	Cylindrical
H85141/64	3/4	19.05	34.90	99.9	50.8	Cylindrical
H85111/16	3/4	19.05	36.40	101.4	50.8	Cylindrical
H85123/32	3/4	19.05	39.00	104.0	50.8	Cylindrical
H85115.0	–	20.00	32.30	97.3	50.0	ISO 9766
H85116.0	–	20.00	34.90	99.9	50.0	ISO 9766
H85117.0	–	20.00	36.40	101.4	50.0	ISO 9766
H85118.0	–	20.00	39.00	104.0	50.0	ISO 9766
H85119.0	–	25.00	40.40	111.4	56.0	ISO 9766
H85120.0	–	25.00	43.00	114.0	56.0	ISO 9766
H85121.0	–	25.00	44.50	115.5	56.0	ISO 9766
H85122.0	–	25.00	46.10	117.1	56.0	ISO 9766
H85123.0	–	25.00	47.00	118.0	56.0	ISO 9766
H85149/64	1"	25.40	40.40	111.4	57.1	Cylindrical
H85151/64	1"	25.40	43.00	114.0	57.1	Cylindrical
H85127/32	1"	25.40	44.50	115.5	57.1	Cylindrical
H85157/64	1"	25.40	46.10	117.1	57.1	Cylindrical
H85159/64	1"	25.40	47.00	118.0	57.1	Cylindrical
H85131/32	1"	25.40	49.30	124.3	57.1	Cylindrical
H8511.1/64	1.1/4	31.75	49.70	124.7	60.3	Cylindrical
H8511.3/64	1.1/4	31.75	52.30	127.3	60.3	Cylindrical
H8511.3/32	1.1/4	31.75	52.80	127.8	60.3	Cylindrical
H8511.1/8	1.1/4	31.75	54.40	129.4	60.3	Cylindrical
H8511.11/64	1.1/4	31.75	55.80	130.8	60.3	Cylindrical
H8511.3/16	1.1/4	31.75	58.40	133.4	60.3	Cylindrical
H85124.0	–	32.00	49.30	124.3	60.0	ISO 9766



Product	DCONMS	DCON MS	LU	OAL	LS	ADINTMS
	[inch]	[mm]	[mm]	[mm]	[mm]	
H85125.0	–	32.00	49.70	124.7	60.0	ISO 9766
H85126.0	–	32.00	52.30	127.3	60.0	ISO 9766
H85127.0	–	32.00	52.80	127.8	60.0	ISO 9766
H85128.0	–	32.00	54.40	129.4	60.0	ISO 9766
H85129.0	–	32.00	55.80	130.8	60.0	ISO 9766
H85130.0	–	32.00	58.40	133.4	60.0	ISO 9766



H853



HYDRA Body 3XD, with Coolant Feed, Bright Nickel Plating

Used with R950, R960 and R970 HYDRA heads. A range of head diameters can be used with the same body. Coolant holes aligned with the heads offer efficient cooling. Bright Nickel Plated surface protects from rust and corrosion, and improves chip evacuation.

HYDRA

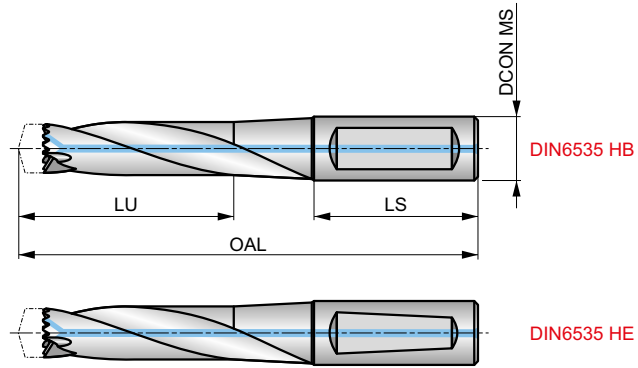

HSS	DORMER	3xD
Bright Ni	DIN 6535HB DIN 6535HE	R

Four (4) screws and one (1) screwdriver are included with a drill body, DCON MS tolerance h6.

Product	DCONMS	DCON MS	LU	OAL	LS	ADINTMS
	[inch]	[mm]	[mm]	[mm]	[mm]	
H85312.0	–	16.00	44.00	105.0	48.0	DIN6535HE
H85331/64	5/8	15.88	44.00	105.0	48.0	DIN6535HB
H85312.5	–	16.00	44.00	105.0	48.0	DIN6535HE
H8531/2	5/8	15.88	44.00	105.0	48.0	DIN6535HB
H85313.0	–	16.00	47.00	110.0	48.0	DIN6535HE
H85317/32	5/8	15.88	47.00	110.0	48.0	DIN6535HB
H85314.0	–	16.00	52.50	116.5	48.0	DIN6535HE
H8539/16	3/4	19.05	52.50	116.5	48.0	DIN6535HB
H85315.0	–	20.00	55.50	126.5	50.0	DIN6535HE
H85339/64	3/4	19.05	55.50	126.5	50.0	DIN6535HB
H85316.0	–	20.00	59.50	131.5	50.0	DIN6535HE
H85341/64	3/4	19.05	59.50	131.5	50.0	DIN6535HB
H85317.0	–	20.00	62.50	136.5	50.0	DIN6535HE
H85311/16	3/4	19.05	62.50	136.5	50.0	DIN6535HB
H85318.0	–	20.00	66.50	141.5	50.0	DIN6535HE
H85323/32	3/4	19.05	66.50	141.5	50.0	DIN6535HB
H85319.0	–	25.00	69.50	156.5	56.0	DIN6535HE
H85349/64	1"	25.40	69.50	156.5	56.0	DIN6535HB
H85320.0	–	25.00	73.50	156.5	56.0	DIN6535HE
H85351/64	1"	25.40	73.50	156.5	56.0	DIN6535HB
H85321.0	–	25.00	76.50	156.5	56.0	DIN6535HE
H85327/32	1"	25.40	76.50	156.5	56.0	DIN6535HB
H85322.0	–	25.00	80.10	161.5	56.0	DIN6535HE
H85357/64	1"	25.40	80.10	161.5	56.0	DIN6535HB
H85323.0	–	25.00	82.50	160.5	56.0	DIN6535HE
H85359/64	1"	25.40	82.50	160.5	56.0	DIN6535HB
H85324.0	–	32.00	86.20	170.2	60.0	DIN6535HE
H85331/32	1"	25.40	86.20	170.2	60.0	DIN6535HB
H85325.0	–	32.00	88.00	170.0	60.0	DIN6535HE
H8531.1/64	1.1/4	31.75	88.00	170.0	60.0	DIN6535HB
H85326.0	–	32.00	92.00	175.0	60.0	DIN6535HE
H8531.3/64	1.1/4	31.75	92.00	175.0	60.0	DIN6535HB
H85327.0	–	32.00	94.00	175.0	60.0	DIN6535HE
H8531.3/32	1.1/4	31.75	94.00	175.0	60.0	DIN6535HB



Product	DCONMS	DCON MS	LU	OAL	LS	ADINTMS
	[inch]	[mm]	[mm]	[mm]	[mm]	
H85328.0	–	32.00	97.00	180.0	60.0	DIN6535HE
H8531.1/8	1.1/4	31.75	97.00	180.0	60.0	DIN6535HB
H85329.0	–	32.00	100.00	185.0	60.0	DIN6535HE
H8531.11/64	1.1/4	31.75	100.00	185.0	60.0	DIN6535HB
H85330.0	–	32.00	104.00	185.0	60.0	DIN6535HE
H8531.3/16	1.1/4	31.75	104.00	185.0	60.0	DIN6535HB
H85332.0	–	32.00	111.50	196.5	60.0	DIN6535HE
H85333.5	–	32.00	116.50	201.5	60.0	DIN6535HE
H85335.0	–	40.00	121.50	216.5	70.0	DIN6535HB
H85336.5	–	40.00	125.50	221.5	70.0	DIN6535HB
H85338.0	–	40.00	131.50	226.5	70.0	DIN6535HB
H85339.5	–	40.00	136.50	231.5	70.0	DIN6535HB
H85341.0	–	40.00	146.50	246.5	70.0	DIN6535HB
H85342.5	–	40.00	151.60	251.6	70.0	DIN6535HB



H855



HYDRA Body 5XD, with Coolant Feed, Bright Nickel Plating

Used with R950, R960 and R970 HYDRA heads. A range of head diameters can be used with the same body. Coolant holes aligned with the heads offer efficient cooling. Bright Nickel Plated surface protects from rust and corrosion, and improves chip evacuation.

HYDRA

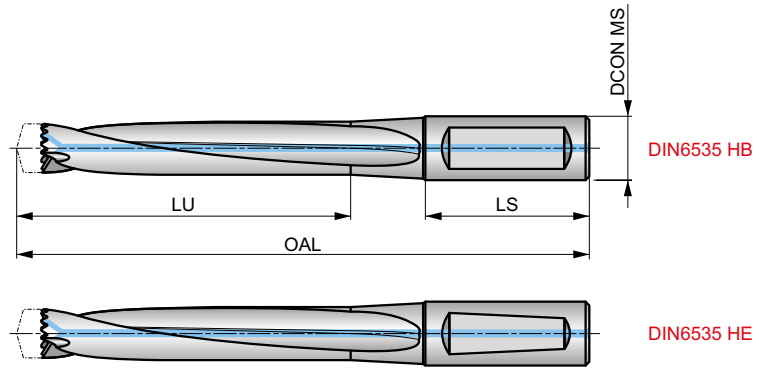

HSS	DORMER	5xD
Bright Ni	DIN 6535HB DIN 6535HE	R

Four (4) screws and one (1) screwdriver are included with a drill body, DCON MS tolerance h6.

Product	DCONMS	DCON MS	LU	OAL	LS	ADINTMS
	[inch]	[mm]	[mm]	[mm]	[mm]	
H85512.0	–	16.00	69.00	130.0	48.0	DIN6535HE
H85531/64	5/8	15.88	69.00	130.0	48.0	DIN6535HB
H85512.5	–	16.00	69.00	130.0	48.0	DIN6535HE
H8551/2	5/8	15.88	69.00	130.0	48.0	DIN6535HB
H85513.0	–	16.00	74.00	140.0	48.0	DIN6535HE
H85517/32	5/8	15.88	74.00	140.0	48.0	DIN6535HB
H85514.0	–	16.00	81.50	146.5	48.0	DIN6535HE
H8559/16	3/4	19.05	81.50	146.5	48.0	DIN6535HB
H85515.0	–	20.00	86.50	156.5	50.0	DIN6535HE
H85539/64	3/4	19.05	86.50	156.5	50.0	DIN6535HB
H85516.0	–	20.00	92.50	166.5	50.0	DIN6535HE
H85541/64	3/4	19.05	92.50	166.5	50.0	DIN6535HB
H85517.0	–	20.00	97.50	171.5	50.0	DIN6535HE
H85511/16	3/4	19.05	97.50	171.5	50.0	DIN6535HB
H85518.0	–	20.00	103.50	176.5	50.0	DIN6535HE
H85523/32	3/4	19.05	103.50	176.5	50.0	DIN6535HB
H85519.0	–	25.00	108.50	191.5	56.0	DIN6535HE
H85549/64	1"	25.40	108.50	191.5	56.0	DIN6535HB
H85520.0	–	25.00	114.50	196.5	56.0	DIN6535HE
H85551/64	1"	25.40	114.50	196.5	56.0	DIN6535HB
H85521.0	–	25.00	119.50	196.5	56.0	DIN6535HE
H85527/32	1"	25.40	119.50	196.5	56.0	DIN6535HB
H85522.0	–	25.00	125.10	201.1	56.0	DIN6535HE
H85557/64	1"	25.40	125.10	201.1	56.0	DIN6535HB
H85523.0	–	25.00	129.50	210.5	56.0	DIN6535HE
H85559/64	1"	25.40	129.50	210.5	56.0	DIN6535HB
H85524.0	–	32.00	135.20	220.2	60.0	DIN6535HE
H85531/32	1"	25.40	135.20	220.2	60.0	DIN6535HB
H85525.0	–	32.00	140.00	225.0	60.0	DIN6535HE
H8551.1/64	1.1/4	31.75	140.00	225.0	60.0	DIN6535HB
H85526.0	–	32.00	146.00	230.0	60.0	DIN6535HE
H8551.3/64	1.1/4	31.75	146.00	230.0	60.0	DIN6535HB
H85527.0	–	32.00	151.00	235.0	60.0	DIN6535HE
H8551.3/32	1.1/4	31.75	151.00	235.0	60.0	DIN6535HB



Product	DCONMS	DCON MS	LU	OAL	LS	ADINTMS
	[inch]	[mm]	[mm]	[mm]	[mm]	
H85528.0	–	32.00	157.00	240.0	60.0	DIN6535HE
H8551.1/8	1.1/4	31.75	157.00	240.0	60.0	DIN6535HB
H85529.0	–	32.00	162.00	245.0	60.0	DIN6535HE
H8551.11/64	1.1/4	31.75	162.00	245.0	60.0	DIN6535HB
H85530.0	–	32.00	167.00	255.0	60.0	DIN6535HE
H8551.3/16	1.1/4	31.75	167.00	255.0	60.0	DIN6535HB
H85532.0	–	32.00	176.50	261.5	60.0	DIN6535HE
H85533.5	–	32.00	186.50	271.5	60.0	DIN6535HE
H85535.0	–	40.00	196.50	291.5	70.0	DIN6535HB
H85536.5	–	40.00	201.50	296.5	70.0	DIN6535HB
H85538.0	–	40.00	211.50	306.5	70.0	DIN6535HB
H85539.5	–	40.00	221.50	316.5	70.0	DIN6535HB
H85541.0	–	40.00	226.50	325.6	70.0	DIN6535HB
H85542.5	–	40.00	236.50	336.5	70.0	DIN6535HB



H858



HYDRA Body 8XD, with Coolant Feed, Bright Nickel Plating

Used with R950, R960 and R970 HYDRA heads. A range of head diameters can be used with the same body. Coolant holes aligned with the heads offer efficient cooling. Bright Nickel Plated surface protects from rust and corrosion, and improves chip evacuation.

HYDRA

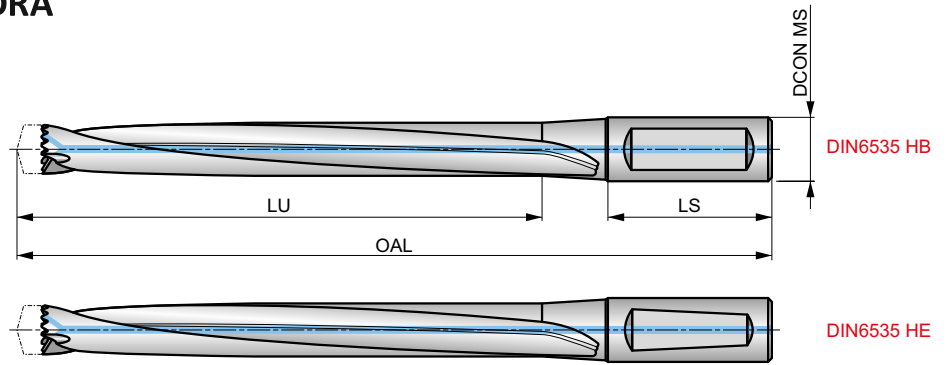

HSS	DORMER	8xD
Bright Ni	DIN 6535HB DIN 6535HE	R

Four (4) screws and one (1) screwdriver are included with a drill body, DCON MS tolerance h6.

Product	DCON MS	LU	OAL	LS	ADINTMS
	[mm]	[mm]	[mm]	[mm]	
H85814.0	16.00	124.50	191.5	48.0	DIN6535HE
H85815.0	20.00	133.50	201.5	50.0	DIN6535HE
H85816.0	20.00	141.50	211.5	50.0	DIN6535HE
H85817.0	20.00	150.50	221.5	50.0	DIN6535HE
H85818.0	20.00	158.50	226.5	50.0	DIN6535HE
H85819.0	25.00	167.50	251.5	56.0	DIN6535HE
H85820.0	25.00	175.50	264.5	56.0	DIN6535HE
H85821.0	25.00	184.50	266.5	56.0	DIN6535HE
H85822.0	25.00	192.10	271.1	56.0	DIN6535HE
H85823.0	25.00	200.50	280.5	56.0	DIN6535HE
H85824.0	32.00	208.20	295.2	60.0	DIN6535HE
H85825.0	32.00	217.00	300.0	60.0	DIN6535HE
H85826.0	32.00	225.00	310.0	60.0	DIN6535HE
H85827.0	32.00	234.00	320.0	60.0	DIN6535HE
H85828.0	32.00	242.00	325.0	60.0	DIN6535HE
H85829.0	32.00	251.00	335.0	60.0	DIN6535HE
H85830.0	32.00	259.00	345.0	60.0	DIN6535HE
H85832.0	32.00	271.50	356.5	60.0	DIN6535HE
H85833.5	32.00	286.50	371.5	60.0	DIN6535HE
H85835.0	40.00	301.50	396.5	70.0	DIN6535HB
H85836.5	40.00	311.50	406.5	70.0	DIN6535HB
H85838.0	40.00	326.50	421.5	70.0	DIN6535HB
H85839.5	40.00	336.50	431.5	70.0	DIN6535HB
H85841.0	40.00	351.50	451.5	70.0	DIN6535HB
H85842.5	40.00	361.50	461.5	70.0	DIN6535HB



H8512



HYDRA Body 12XD, with Coolant Feed, Bright Nickel Plating

Used with R950, R960 and R970 HYDRA heads. A range of head diameters can be used with the same body. Coolant holes aligned with the heads offer efficient cooling. Flanged shank prevents the drill from wandering in the holder. Nickel Plated surface protects from rust and corrosion, and improves chip evacuation.

HYDRA

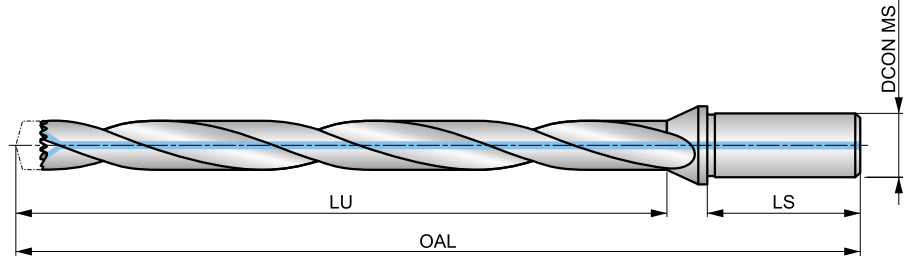

HSS	DORMER	12xD
Bright Ni		R

Four (4) screws and one (1) screwdriver are included with a drill body, DCON MS tolerance h6.

Product	DCON MS	LU	OAL	LS
	[mm]	[mm]	[mm]	[mm]
H851214.0	16.00	168.00	236.0	48.0
H851215.0	20.00	180.00	250.3	50.0
H851216.0	20.00	192.00	262.6	50.0
H851217.0	20.00	204.00	275.0	50.0
H851218.0	20.00	216.00	287.2	50.0
H851219.0	25.00	228.00	305.6	56.0
H851220.0	25.00	240.00	317.8	56.0
H851221.0	25.00	252.00	330.1	56.0
H851222.0	25.00	264.00	343.0	56.0
H851223.0	25.00	276.00	354.8	56.0
H851224.0	32.00	288.00	371.7	60.0
H851225.0	32.00	300.00	383.8	60.0



H860

HYDRA Screws

Replacement screws used to securely hold HYDRA heads in place.



HYDRA

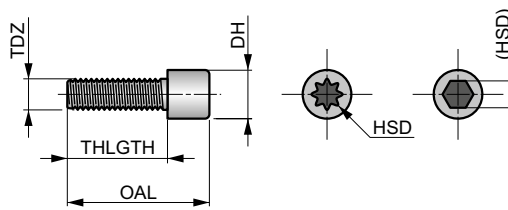

Product	Nr.	TDZ	OAL	THLGTH	DH	HSD
			[mm]			
H860N1	1	M2.2	7.5	5.70	3.5	8IP
H860N2	2	M2.5	9.0	7.00	4.1	10IP
H860N3	3	M3.0	10.5	8.00	4.9	15IP
H860N4	4	M3.5	11.5	8.80	5.5	15IP
H860N5	5	M4.0	12.5	9.50	6.0	20IP
H860N6	6	M4.5	14.3	10.80	6.8	25IP
H860N7	7	M5.0	20.0	15.00	8.5	4



H861

HYDRA Screw Driver

Screwdrivers used to tighten HYDRA screws.



HYDRA

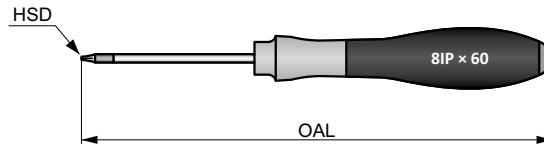

Product	Nr.	HSD	OAL
			[mm]
H861N1	N1	8IP	164.0
H861N2	N2	10IP	191.0
H861N3	N3	15IP	191.0
H861N4	N4	20IP	218.0
H861N5	N5	25IP	218.0
H861N6	N6	4	186.0



CUTTING CONDITIONS CORRECTION FACTORS (BASED ON HYDRA BODY LENGTHS)

H851	Apply starting values for speed and feed with a correction factor of 1.10
H853	Apply starting values for speed and feed with a correction factor of 1.00
H855	Apply starting values for speed and feed with a correction factor of 0.95
H858	Apply starting values for speed and feed with a correction factor of 0.90
H8512	Apply starting values for speed and feed with a correction factor of 0.80



HYDRA
TECHNICAL INFORMATION



HYDRA – TECHNICAL INFO

Torque table

H860	H861	Hydra Head \varnothing Metric Range	Hydra Head \varnothing Fractional Range	Hydra Head \varnothing Decimal Size Range (min. / max.)	Torque Values Nm (Metric System)	Torque Values in/lbs (Inch System)
H860N1	H861N1	12.0 mm – 15.5 mm	15/32" – 39/64"	0.4688" – 0.6102"	0.75 – 0.99	6.6 – 8.8
H860N2	H861N2	15.6 mm – 18.5 mm	5/8" – 23/32"	0.6142" – 0.7283"	0.93 – 1.24	8.2 – 11.0
H860N3	H861N3	18.6 mm – 21.5 mm	47/64" – 27/32"	0.7323" – 0.8465"	1.84 – 2.44	16.3 – 21.6
H860N4	H861N3	22.0 mm – 24.5 mm	55/64" – 31/32"	0.8594" – 0.9688"	2.73 – 3.72	24.2 – 32.9
H860N5	H861N4	25.0 mm – 27.5 mm	63/64" – 1-3/32"	0.9843" – 1.0938"	4.14 – 5.52	36.6 – 48.8
H860N6	H861N5	28.0 mm – 33.5 mm	1-7/64" – 1-19/64"	1.1024" – 1.3189"	4.97 – 6.63	44.0 – 58.7
H860N7	H861N6	34.0 mm – 42.0 mm	1-11/32" – 1-5/8"	1.3386" – 1.6535"	7.2	63.7

Screws and screw-driver data

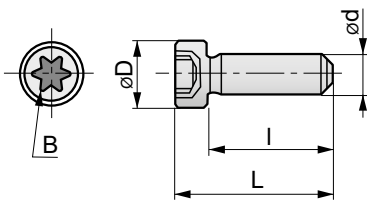

e-code	d	Pitch	L [mm]	I [mm]	D [mm]	B
H860N1	M2.2	0.45	7.5	5.7	3.5	8IP
H860N2	M2.5	0.45	9.0	7.0	4.1	10IP
H860N3	M3.0	0.50	10.5	8.0	4.9	15IP
H860N4	M3.5	0.60	11.5	8.8	5.5	15IP
H860N5	M4.0	0.70	12.5	9.5	6.0	20IP
H860N6	M4.5	0.75	14.3	10.8	6.8	25IP

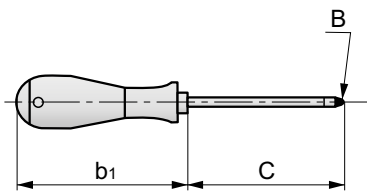

e-code	B	C	b ₁
H861N1	8IP	60	104
H861N2	10IP	80	111
H861N3	15IP	80	111
H861N4	20IP	100	118
H861N5	25IP	100	118

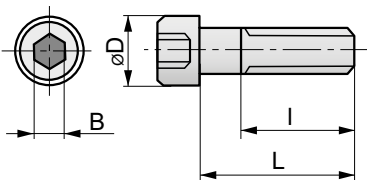

e-code	d	Pitch	L [mm]	I [mm]	D [mm]	B
H860N7	M5.0	0.8	15	full	8.5	4

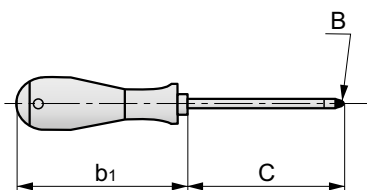

e-code	B	C	b ₁
H861N6	4	75	111



Apply special programming for 8xD and 12xD drilling

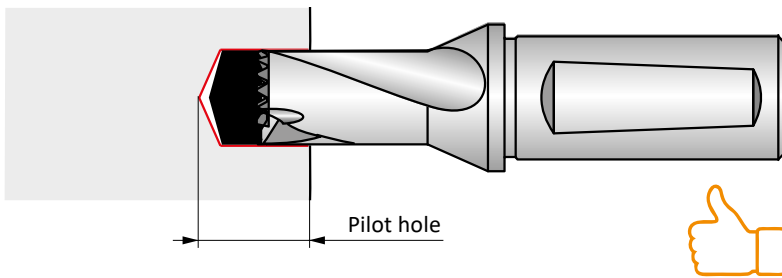

Drill a pilot hole (1.5xD to 3xD depth) with the same HYDRA head diameter (if needed check the runout of the drill max. +/- 0.05 mm).

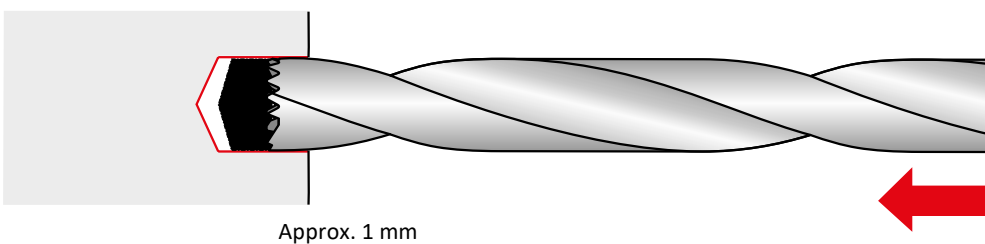

Enter the pilot hole with the 8xD or 12xD Body running a maximum of 500 rpm, to approximately 1mm above the pre-drilled pilot hole depth.

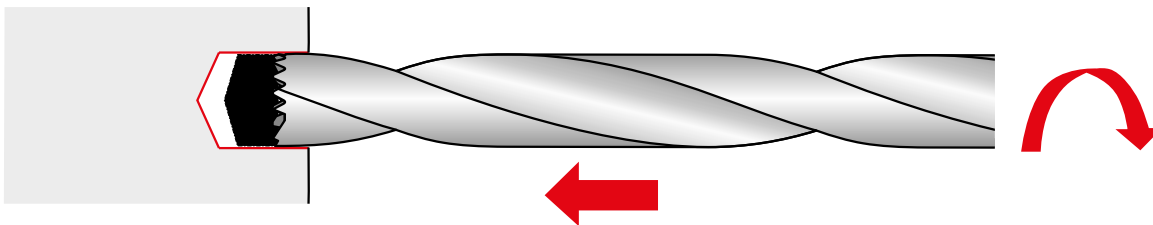

Start coolant flow and increase the rotational speed up to the recommended RPM.
Note: Apply a short dwell time don't start the feed before recommended RPM is reached.

Drill without pecking to the required depth.

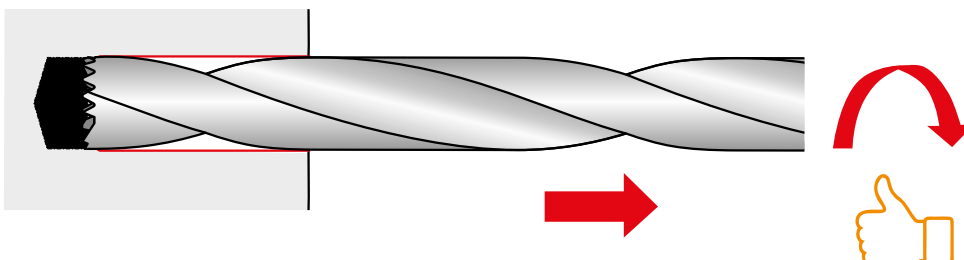

When the required depth is reached, retract the drill by approximately 0.1 mm to 0.5 mm and reduce to 500 rpm followed by a complete retraction with normal feed. **Note: retracting the drill with a higher spindle speed may cause a shoulder damage from run out or destroy the hole surface and tolerance.**



Drilling hints & tips with the hydra drill

Coolants

For maximum chip evacuation and tool performance, coolant use is recommended. Emulsion coolant concentration of 6 – 8% is recommended for most applications, with a coolant pressure of 20 bar (290 PSI) or higher. For high strength steel, stainless steels and tougher drilling applications, use a higher concentration of 10 – 12%. In these applications, particularly in stainless steels, it is recommended to use the maximum coolant pressure on the machine. The Hydra-drill coolant holes provide improved web strength and reduce heat at the cutting edges for increased productivity and longer tool life.

Holders

Always use tool holders and collets that provide good concentricity

between the drill and the machine spindle. Use a positive stop to prevent the tool from backing up into the holder. Radial runout in the tool assembly must be accurately checked and maintained.

Workpiece

A secure and rigid workpiece will minimise deflection, and allow for better accuracy and true position of the hole.

Feeds

It is important not to underfeed the drill which will cause it to dwell and dull. This is particularly true in work hardening materials. Feed rates should be high enough for proper chip formation.

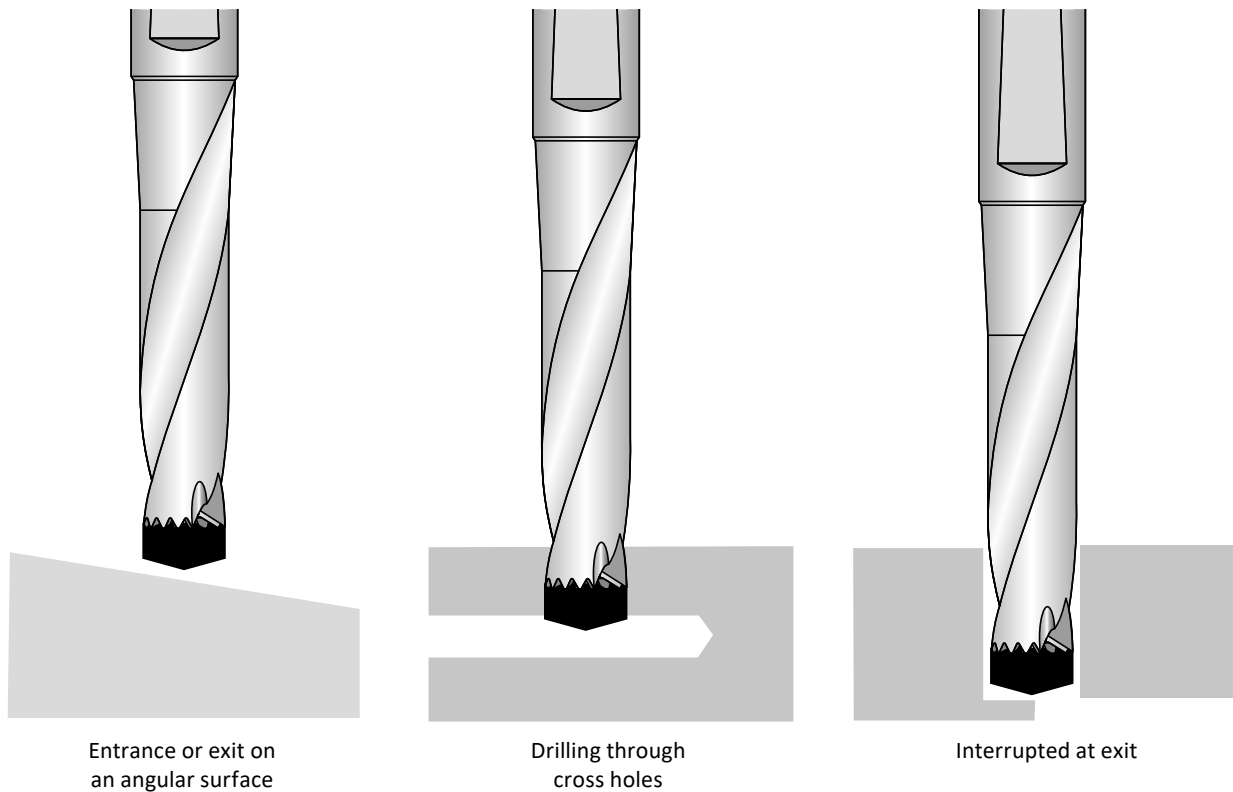

In these drilling scenarios, reducing feed rate to 1/3 (33%) is generally recommended. Drilling into an entry angle of more than 10° is NOT recommended – surface should be milled flat first.



GENERAL – TECHNICAL INFO

	Grade	Hardness (HV10)	C %	W %	Mo %	Cr %	V %	Co %	Tool Material
HSS	M2	810 – 850	0.9	6.4	5.0	4.2	1.8	–	HSS

Properties	HSS materials	Carbide materials	K10/30F (often used for solid tools)
Hardness [HV30]	800 – 950	1300 – 1800	1600
Density [g/cm ³]	8.0 – 9.0	7.2 – 15	14.45
Compressive strength [N/mm ²]	3000 – 4000	3000 – 8000	6250
Flexural strength, (bending) [N/mm ²]	2500 – 4000	1000 – 4700	4300
Heat resistance [°C]	550	1000	900
E-module [KN/mm ²]	260 – 300	460 – 630	580
Grain size [µm]	–	0.2 – 10	0.8

The combination of hard particle (WC) and binder metal (Co) give the following changes in characteristics.

Characteristic	Higher WC content give	Higher Co content give
Hardness	Higher hardness	Lower hardness
Compressive strength (CS)	Higher CS	Lower CS
Bending strength (BS)	Lower BS	Higher BS

Grain size also influences the material properties. Small grain sizes means higher hardness and coarse grains give more toughness.



GENERAL – TECHNICAL INFO

Industry Standard tolerances For Shafts & Holes

Tolerance values are shown in Microns (μm)

Formula for Microns ...1 $\mu\text{m} = 0.001 \text{ mm} / 0.000039''$

Tolerance	Diameter [mm]							
	> 1 ≤ 3	> 3 ≤ 6	> 6 ≤ 10	> 10 ≤ 18	> 18 ≤ 30	> 30 ≤ 50	> 50 ≤ 80	> 80 ≤ 120
	Diameter [inch]							
	> 0.039" ≤ 0.118"	> 0.118" ≤ 0.236"	> 0.236" ≤ 0.394"	> 0.394" ≤ 0.709"	> 0.709" ≤ 1.181"	> 1.181" ≤ 1.968"	> 1.968" ≤ 3.149"	> 3.149" ≤ 4.724"
Tolerance values [μm]								
e8	-14 / -28	-20 / -38	-25 / -47	-32 / -59	-40 / -73	-50 / -89	-60 / -106	-72 / -126
f6	-6 / -12	-10 / -18	-13 / -22	-16 / -27	-20 / -33	-25 / -41	-30 / -49	-36 / -58
f7	-6 / -16	-10 / -22	-13 / -28	-16 / -34	-20 / -41	-25 / -50	-30 / -60	-36 / -71
h6	0 / -6	0 / -8	0 / -9	0 / -11	0 / -13	0 / -16	0 / -19	0 / -22
h7	0 / -10	0 / -12	0 / -15	0 / -18	0 / -21	0 / -25	0 / -30	0 / -35
h8	0 / -14	0 / -18	0 / -22	0 / -27	0 / -33	0 / -39	0 / -46	0 / -54
h9	0 / -25	0 / -30	0 / -36	0 / -43	0 / -52	0 / -62	0 / -74	0 / -87
h10	0 / -40	0 / -48	0 / -58	0 / -70	0 / -84	0 / -100	0 / -120	0 / -140
h11	0 / -60	0 / -75	0 / -90	0 / -110	0 / -130	0 / -160	0 / -190	0 / -220
h12	0 / -100	0 / -120	0 / -150	0 / -180	0 / -210	0 / -250	0 / -300	0 / -350
k10	+40 / 0	+48 / 0	+58 / 0	+70 / 0	+84 / 0	+100 / 0	+120 / 0	+140 / 0
k12	+100 / 0	+120 / 0	+150 / 0	+180 / 0	+210 / 0	+250 / 0	+300 / 0	+350 / 0
m7	+2 / +12	+4 / +16	+6 / +21	+7 / +25	+8 / +29	+9 / +34	+11 / +41	+13 / +48
js14	+/-125	+/-150	+/-180	+/-215	+/-260	+/-310	+/-370	+/-435
js16	+/-300	+/-375	+/-450	+/-550	+/-650	+/-800	+/-950	+/-1100
H7	+10 / 0	+12 / 0	+15 / 0	+18 / 0	+21 / 0	+25 / 0	+30 / 0	+35 / 0
H8	+14 / 0	+18 / 0	+22 / 0	+27 / 0	+33 / 0	+39 / 0	+46 / 0	+54 / 0
H9	+25 / 0	+30 / 0	+36 / 0	+43 / 0	+52 / 0	+62 / 0	+74 / 0	+87 / 0
H12	+100 / 0	+120 / 0	+150 / 0	+180 / 0	+210 / 0	+250 / 0	+300 / 0	+350 / 0
P9	-6 / -31	-12 / -42	-15 / -51	-18 / -61	-22 / -74	-26 / -86	-32 / -106	-37 / -124
S7	-13 / -22	-15 / -27	-17 / -32	-21 / -39	-27 / -48	-34 / -59	-42 / -72	-58 / -93



GENERAL – TECHNICAL INFO

Table of Cutting Speeds

		Vc															
m/min.		5	8	10	15	20	25	30	40	50	60	70	80	90	100	110	150
SFM (feet/min.)		16	26	32	50	66	82	98	130	165	197	230	262	296	330	362	495
Ø		RPM															
mm	inch																
1.00	–	1592	2546	3183	4775	6366	7958	9549	12732	15916	19099	22282	25465	28648	31831	35014	47747
1.50	–	1061	1698	2122	3183	4244	5305	6366	8488	10610	12732	14854	16977	19099	21221	23343	31831
2.00	–	796	1273	1592	2387	3183	3979	4775	6366	7958	9549	11141	12732	14324	15916	17507	23873
2.50	–	637	1019	1273	1910	2546	3183	3820	5093	6366	7639	8913	10186	11459	12732	14006	19099
3.00	–	531	849	1061	1592	2122	2653	3183	4244	5305	6366	7427	8488	9549	10610	11671	15916
3.18	1/8	500	801	1001	1501	2002	2502	3003	4004	5005	6006	7007	8008	9009	10010	11011	15015
3.50	–	455	728	909	1364	1819	2274	2728	3638	4547	5457	6366	7276	8185	9095	10004	13642
4.00	–	398	637	796	1194	1592	1989	2387	3183	3979	4775	5570	6366	7162	7958	8754	11937
4.50	–	354	566	707	1061	1415	1768	2122	2829	3537	4244	4951	5659	6366	7074	7781	10610
4.76	3/16	334	535	669	1003	1337	1672	2006	2675	3344	4012	4681	5350	6018	6687	7356	10031
5.00	–	318	509	637	955	1273	1592	1910	2546	3183	3820	4456	5093	5730	6366	7003	9549
6.00	–	265	424	531	796	1061	1326	1592	2122	2653	3183	3714	4244	4775	5305	5836	7958
6.35	1/4	251	401	501	752	1003	1253	1504	2005	2506	3008	3509	4010	4511	5013	5514	7519
7.00	–	227	364	455	682	909	1137	1364	1819	2274	2728	3183	3638	4093	4547	5002	6821
7.94	5/16	200	321	401	601	802	1002	1203	1604	2004	2405	2806	3207	3608	4009	4410	6013
8.00	–	199	318	398	597	796	995	1194	1592	1989	2387	2785	3183	3581	3979	4377	5968
9.00	–	177	283	354	531	707	884	1061	1415	1768	2122	2476	2829	3183	3537	3890	5305
9.53	3/8	167	267	334	501	668	835	1002	1336	1670	2004	2338	2672	3006	3340	3674	5010
10.00	–	159	255	318	477	637	796	955	1273	1592	1910	2228	2546	2865	3183	3501	4775
11.11	7/16	143	229	287	430	573	716	860	1146	1433	1719	2006	2292	2579	2865	3152	4298
12.00	–	133	212	265	398	531	663	796	1061	1326	1592	1857	2122	2387	2653	2918	3979
12.70	1/2	125	201	251	376	501	627	752	1003	1253	1504	1754	2005	2256	2506	2757	3760
14.00	–	114	182	227	341	455	568	682	909	1137	1364	1592	1819	2046	2274	2501	3410
14.29	9/16	111	178	223	334	446	557	668	891	1114	1337	1559	1782	2005	2228	2450	3341
15.00	–	106	170	212	318	424	531	637	849	1061	1273	1485	1698	1910	2122	2334	3183
15.88	5/8	100	160	200	301	401	501	601	802	1002	1203	1403	1604	1804	2004	2205	3007
16.00	–	99	159	199	298	398	497	597	796	995	1194	1393	1592	1790	1989	2188	2984
17.46	11/16	91	146	182	273	365	456	547	729	912	1094	1276	1458	1641	1823	2005	2735
18.00	–	88	141	177	265	354	442	531	707	884	1061	1238	1415	1592	1768	1945	2653
19.05	3/4	84	134	167	251	334	418	501	668	835	1003	1170	1337	1504	1671	1838	2506
20.00	–	80	127	159	239	318	398	477	637	796	955	1114	1273	1432	1592	1751	2387
24.00	–	66	106	133	199	265	332	398	531	663	796	928	1061	1194	1326	1459	1989
25.00	–	64	102	127	191	255	318	382	509	637	764	891	1019	1146	1273	1401	1910
27.00	–	59	94	118	177	236	295	354	472	589	707	825	943	1061	1179	1297	1768
30.00	–	53	85	106	159	212	265	318	424	531	637	743	849	955	1061	1167	1592
32.00	–	50	80	99	149	199	249	298	398	497	597	696	796	895	995	1094	1492
36.00	–	44	71	88	133	177	221	265	354	442	531	619	707	796	884	973	1326
40.00	–	40	64	80	119	159	199	239	318	398	477	557	637	716	796	875	1194
50.00	–	32	51	64	95	127	159	191	255	318	382	446	509	573	637	700	955



GENERAL – TECHNICAL INFO

Hardness and Tensile Strength

HV	HRC	HB	Tensile Strength	
			[N/mm ²]	[Tons/sq. in.]
940	68	–	–	–
900	67	–	–	–
864	66	–	–	–
829	65	–	–	–
800	64	–	–	–
773	63	–	–	–
745	62	–	–	–
720	61	–	–	–
698	60	–	–	–
675	59	–	–	–
655	58	–	2200	142
650	–	618	2180	141
640	–	608	2145	139
639	57	607	2140	138
630	–	599	2105	136
620	–	589	2070	134
615	56	584	2050	133
610	–	580	2030	131
600	–	570	1995	129
596	55	567	1980	128
590	–	561	1955	126
580	–	551	1920	124
578	54	549	1910	124
570	–	542	1880	122
560	53	532	1845	119
550	–	523	1810	117
544	52	517	1790	116
540	–	513	1775	115
530	–	504	1740	113
527	51	501	1730	112
520	–	494	1700	110
514	50	488	1680	109
510	–	485	1665	108
500	–	475	1630	105
497	49	472	1620	105
490	–	466	1595	103
484	48	460	1570	102
480	–	456	1555	101
473	47	449	1530	99
470	–	447	1520	98
460	–	437	1485	96
458	46	435	1480	96
450	–	428	1455	94
446	45	424	1440	93
440	–	418	1420	92

HV	HRC	HB	Tensile Strength	
			[N/mm ²]	[Tons/sq. in.]
434	44	413	1400	91
423	43	402	1360	88
413	42	393	1330	86
403	41	383	1300	84
392	40	372	1260	82
382	39	363	1230	80
373	38	354	1200	78
364	37	346	1170	76
355	36	337	1140	74
350	–	333	1125	73
345	35	328	1110	72
340	–	323	1095	71
336	34	319	1080	70
330	–	314	1060	69
327	33	311	1050	68
320	–	304	1030	67
317	32	301	1020	66
310	31	295	995	64
302	30	287	970	63
300	–	285	965	62
295	–	280	950	61
293	29	278	940	61
290	–	276	930	60
287	28	273	920	60
285	–	271	915	59
280	27	266	900	58
275	–	261	880	57
272	26	258	870	56
270	–	257	865	56
268	25	255	860	56
265	–	252	850	55
260	24	247	835	54
255	23	242	820	53
250	22	238	800	52
245	–	233	785	51
243	21	231	780	50
240	–	228	770	50
235	–	223	755	49
230	–	219	740	48
225	–	214	720	47
220	–	209	705	46
215	–	204	690	45
210	–	199	675	44
205	–	195	660	43
200	–	190	640	41



DORMER PRAMET



QUICK SEARCH

Easily and quickly perform a text search within any publication launched by Dormer Pramet in recent time through our library app. Download it today from your relevant app store. **Simply Reliable.**

 Download on the
App Store

 GET IT ON
Google Play

 Download on
AppGallery

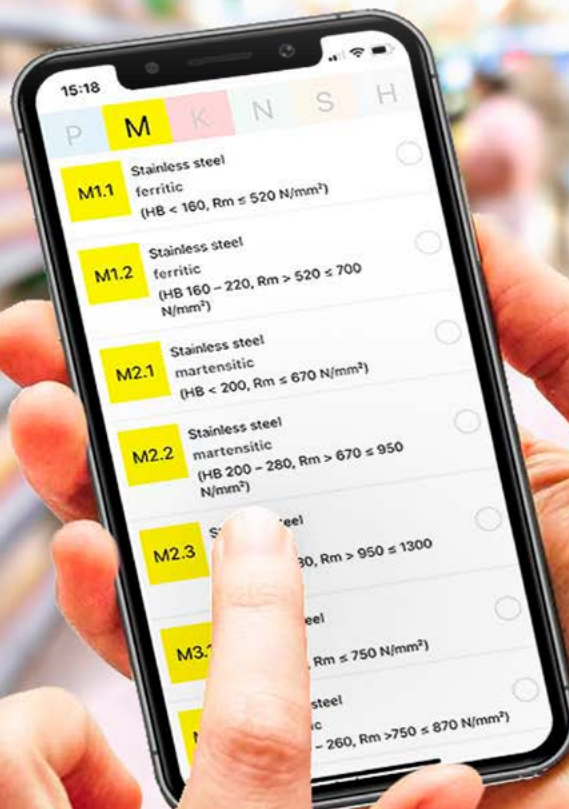



INDEXABLE DRILLS



INDEXABLE DRILLS – OVERVIEW

Working length	2×D	3×D	4×D	5×D	XPET..AP	SCET..UD	XPET..AP-SD	SCET..-SD
Picture								
Coolant					-	-	-	-
	313	315	318	320	324	323	324	323
Drill type	802D	803D	804D	805D	-	-	-	-
Drill tolerance	± 0.05	± 0.05	± 0.05	± 0.05	-	-	-	-
Hole tolerance *	0/+0.2	0/+0.3	0/+0.4	0/+0.5	-	-	-	-
Surface finish *	R _a 2–6 μm	R _a 2–6 μm	R _a 2–6 μm	R _a 2–6 μm	-	-	-	-
Diameter range	15.0–40.0	15.0–58.0	17.0–58.0	19.0–31.0	-	-	-	-
Application areas	P1				■	■	■	■
	P2				■	■	■	■
	P3				■	■	■	■
	P4				■	■	■	■
	M1						■	■
	M2						■	■
	M3						■	■
	M4						■	■
	K1				▣	■	▣	▣
	K2				▣	■	▣	▣
	K3				▣	■	▣	▣
	K4				▣	■	▣	▣
	K5				▣	■	▣	▣
	S1						▣	▣
	S2						▣	▣
	S3						▣	▣
S4						▣	▣	

* The tolerance of drilled hole and surface finish are heavily dependent on machining conditions.



INDEXABLE DRILLS – GRADES NAVIGATOR

Grade Identification	Area of Application	Application	Feed	Cutting speed	Resistance to adverse Working Conditions	Coating	Colour	Substrate	Coolant benefit	Grade description
D9335	P20 - P35	■				MT-CVD	Black	FGM	+++	This grade is recommended for the peripheral insert in indexable drills, it is more suited to higher cutting speeds and feeds.
	M15 - M30	■								
	K15 - K35	■								
	S10 - S20	■								
D8330	P20 - P35	■				PVD	Yellow	submicron H	+++	This is a universal grade for the peripheral insert in indexable drills, it can be used for most materials and stands out for its operational reliability.
	M15 - M30	■								
	K15 - K35	■								
	S10 - S20	■								
D8345	P30 - P50	■				PVD	Yellow	submicron H	+++	This grade is a universal grade for the central insert in indexable drills, it is an extremely tough suited to most materials.
	M20 - M40	■								
	K30 - K40	■								
	S20 - S30	■								

Substrat

submicron H	WC-Co based substrate fine grained (< 1 µm)
FGM	Functionally graded substrate

Coating

MT-CVD	Medium-temperature chemical method of coating
PVD	Low-temperature physical method of coating

Benefits of Cutting Fluid

+++	Use of coolant is essential
-----	-----------------------------

ISO CODE DESIGNATION – INSERTS

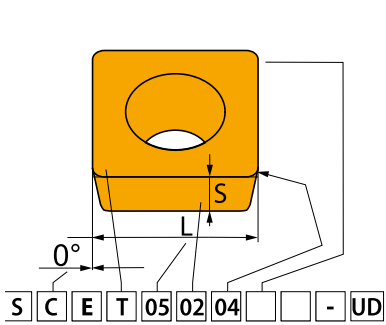

ISO	1	2	3	4
	S	C	E	T
ANSI	1	2	3	4
	S	C	E	T

1				2				4			
Insert shape				Insert clearance angle				Insert type			
H	O	P	R	A	B	N	R	F	A	M	G
S	T	C	D	C	D	T	F	W	T	Q	U
E	M	V	W	E	F	B	H	C	J	X	
L	A	B	K	G	N						
				P	O						

3 3 Tolerances

	[mm]			["]		
	M(±)	S(±)	IC(±)	M(±)	S(±)	IC(±)
A	0.005	0.025	0.025	.0002"	.001"	.0010"
F	0.005	0.025	0.013	.0002"	.001"	.0005"
C	0.013	0.025	0.025	.0005"	.001"	.0010"
H	0.013	0.025	0.013	.0005"	.001"	.0005"
E	0.025	0.025	0.025	.0010"	.001"	.0010"
G	0.025	0.130	0.025	.0010"	.005"	.0010"
J	0.005	0.025	0.05 – 0.13	.0002"	.001"	.002 – 0.005"
K	0.013	0.025	0.05 – 0.13	.0005"	.001"	.002 – 0.005"
L	0.025	0.025	0.05 – 0.13	.0010"	.001"	.002 – 0.005"
M	0.08 – 0.18	0.130	0.05 – 0.13	.003 – 0.007"	.005"	.002 – 0.005"
N	0.08 – 0.18	0.025	0.05 – 0.13	.003 – 0.007"	.001"	.002 – 0.005"
U	0.05 – 0.38	0.130	0.05 – 0.13	.005 – 0.015"	.005"	.003 – 0.010"

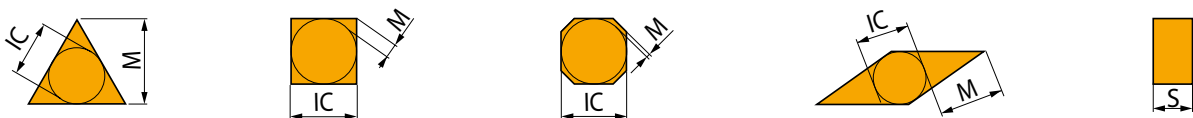



ISO CODE DESIGNATION – INSERTS

5	6	7	8	9	10
05	02	04			UD
5	6	7	8	9	10
1.8	1.5	1			UD

5		5												
Insert cutting edge length (insert size)														
d = IC		H	O	P	S	T	C	D	E	M	V	W	R	K
[mm]	[in]													
3.97	5/32"				03	06		04			06	02		
4.76	3/16"				04	08	04	05	04	04	08	L3		
5.56	7/32"				05	09	05	06	05	05	09	03		
6.35	1/4"	03	02	04	08	11	06	07	08	08	11	04	06	
7.94	5/16"	04	03	05	07	13	08	09	06	07	13	05	07	
9.525	3/8"	05	04	07	09	16	09	11	09	09	16	06	09	16
12.7	1/2"	07	05	09	12	22	12	15	13	12	22	08	12	
15.875	5/8"	09	06	11	15	27	16	19	16	15	27	10	15	
19.05	3/4"	11	07	13	19	33	19	23	19	19	33	13	19	
25.40	1"	14	10	18	25	44	25	31	26	25	44	17	25	
31.75	1 1/4"	18	13	23	31	54	32	38	32	31	54	21	31	

6		7	
Insert thickness		Insert nose radius	
	S	RE	
	[mm]	[mm]	["]
01	1.59	0	0"
T1	1.98	0.2	1/128"
02	2.38	0.4	1/64"
03	3.18	0.8	1/32"
T3	3.97	1.2	3/64"
04	4.76	1.6	1/16"
05	5.56	2.4	3/32"
06	6.35	3.2	1/8"
07	7.94	Round inserts	
09	9.52		
		d = I.C.	
		["]	00
		[mm]	M0

ANSI					
5		6		7	
Inscribed circle		Insert thickness		Insert nose radius	
d = I.C.		S		RE	
Symbol	[mm]	[mm]	["]	[mm]	["]
1	3.175	1	1.588	0	0"
1.2	3.969	1.2	1.984	0.099	1/256"
1.5	4.763	1.5	2.381	0.198	1/128"
1.8	5.556	2	3.175	0.397	1/64"
2	6.350	2.5	3.969	0.794	1/32"
2.5	7.938	3	4.763	1.191	3/64"
3	9.525	3.5	5.556	1.588	1/16"
4	12.700	4	6.350	1.984	5/64"
5	15.875	5	7.938	2.381	3/32"
6	19.050	6	9.525	3.175	1/8"
7	22.225	7	11.113	3.969	5/32"
8	25.400	8	12.700	4.763	3/16"
10	31.750	9	14.288	5.556	7/32"
12	38.100	10	15.875	6.350	1/4"

8		8	
Insert cutting edge design			
	Sharp edges		Rounded edges
	Edges with facet		Rounded edges with facet
	Edges with double facet		Rounded edges with double facet
9		9	
Feed direction			
R		N	
L			
10		10	
Chip breaker designation			



INDEXABLE DRILLS – CODE KEY

1	2	3		4		5		6	7
8	05	D	-	19	-	95	-	S	25

*Marking is valid for types produced from 2011



Indexable drill*

1		2		3		4	
Tool type		Approximate length		Variant		Cutting diameter	
8	Indexable drill	02	2 × DC	D	Drill	15.5	DC = 15.5 mm
		03	3 × DC				19
		04	4 × DC				
		05	5 × DC				
5		6		7			
Max. drilling depth		Type of shank		Shank diameter			
35	35 mm	E	Whistle Notch	25	DCON MS = 25 mm		
95	95 mm			32	DCON MS = 32 mm		
140	140 mm	S	ISO 9766	40	DCON MS = 40 mm		



802D

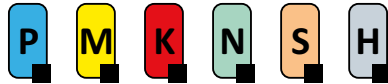

PRAMET

S



2xD 802D Indexable Insert Drill body with Internal Coolant Feed

High performance indexable insert drill body for drilling blind and through holes. Also, potentially cross hole, off center and stack drilling, helical interpolation, plunging, drilling on concave or angled surfaces, drilling with interrupted cuts, chamfer drilling and boring. Available from Ø15 up to Ø40 mm in 2xD.

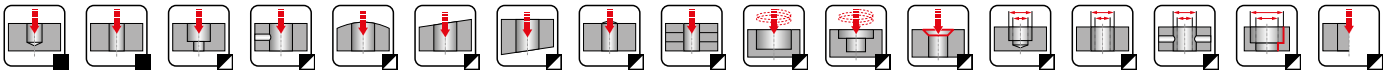
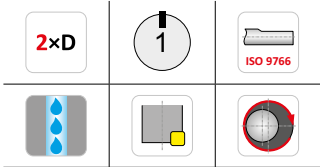
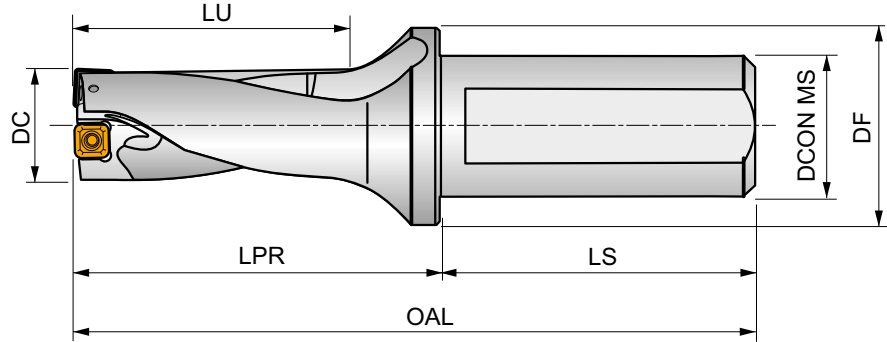

Product	DC	APMX	OAL	LPR	LS	LU	DCON MS	DF	$\overset{-}{D}$	$\overset{+}{D}$	G1300	G1301	G1302	G1303	G1304	G1305	G1306	G1307	G1308	G1309	kg	HM001
	[mm]	[mm]	[mm]	[mm]	[mm]	[mm]		[mm]	[mm]	[mm]												
802D-15-30-S25	15	30.00	121	65	56	34.5	25	35	0.25	0.35	EP253253	GI300	GI313	0.30	HM001							
802D-16-32-S25	16	32.00	123	67	56	37	25	35	0.15	0.45	EP253253	GI300	GI313	0.30	HM001							
802D-17-34-S25	17	34.00	125	69	56	39.5	25	35	0.10	0.50	EP253253	GI300	GI313	0.31	HM001							
802D-18-36-S25	18	36.00	127	71	56	42	25	35	0.35	0.25	EP253253	GI301	GI314	0.31	HM002							
802D-19-38-S25	19	38.00	129	73	56	44.5	25	35	0.15	0.45	EP253253	GI301	GI314	0.32	HM002							
802D-20-40-S25	20	40.00	131	75	56	47	25	35	0.10	0.45	EP253253	GI302	GI315	0.33	HM003							
802D-21-42-S25	21	42.00	133	77	56	49.5	25	35	0.10	0.50	EP253253	GI302	GI315	0.34	HM003							
802D-22-44-S25	22	44.00	135	79	56	52	25	35	0.45	0.50	EP253253	GI303	GI316	0.35	HM004							
802D-23-46-S25	23	46.00	137	81	56	54.5	25	35	0.35	0.50	EP253253	GI304	GI317	0.36	HM005							
802D-24-48-S25	24	48.00	139	83	56	57	25	35	0.15	0.50	EP253253	GI304	GI317	0.37	HM005							
802D-25-50-S32	25	50.00	145	85	60	57	32	42	0.15	0.50	EP324058	GI304	GI317	0.57	HM005							
802D-26-52-S32	26	52.00	147	87	60	59.5	32	42	0.10	0.50	EP324058	GI304	GI317	0.58	HM005							
802D-27-54-S32	27	54.00	149	89	60	62	32	42	0.50	0.30	EP324058	GI305	GI318	0.59	HM006							
802D-28-56-S32	28	56.00	151	91	60	64.5	32	42	0.30	0.50	EP324058	GI306	GI319	0.61	HM007							
802D-29-58-S32	29	58.00	153	93	60	67	32	42	0.20	0.50	EP324058	GI306	GI319	0.62	HM007							
802D-30-60-S32	30	60.00	155	95	60	69.5	32	42	0.15	0.50	EP324058	GI306	GI319	0.67	HM007							
802D-32-64-S32	32	64.00	159	99	60	70	32	42	0.50	0.35	EP324058	GI307	GI320	0.68	HM008							
802D-32-64-S40	32	64.00	167	99	68	70	40	50	0.50	0.35	-	GI307	GI320	1.03	HM008							
802D-34-68-S32	34	68.00	163	103	60	75	32	42	0.25	0.50	EP324058	GI307	GI320	0.73	HM008							
802D-34-68-S40	34	68.00	171	103	68	75	40	50	0.25	0.50	-	GI307	GI320	1.07	HM008							
802D-36-72-S32	36	72.00	167	107	60	80	32	42	0.10	0.50	EP324058	GI308	GI321	0.76	HM009							
802D-36-72-S40	36	72.00	173	105	68	77.5	40	50	0.10	0.50	-	GI308	GI321	1.11	HM009							
802D-38-76-S32	38	76.00	171	111	60	85	32	42	0.50	0.50	EP324058	GI308	GI321	0.83	HM009							
802D-38-76-S40	38	76.00	179	111	68	85	40	50	0.50	0.50	-	GI308	GI321	1.17	HM009							
802D-40-80-S32	40	80.00	175	115	60	90	32	42	0.20	0.50	EP324058	GI309	GI322	0.91	HM009							
802D-40-80-S40	40	80.00	183	115	68	90	40	50	0.20	0.50	-	GI309	GI322	1.25	HM009							



GI300	XPET 0502AP	SCET 050204-UD
GI301	XPET 0602AP	SCET 050204-UD
GI302	XPET 0602AP	SCET 060204-UD
GI303	XPET 0703AP	SCET 060204-UD
GI304	XPET 0703AP	SCET 070308-UD
GI305	XPET 0903AP	SCET 070308-UD
GI306	XPET 0903AP	SCET 09T308-UD
GI307	XPET 11T3AP	SCET 09T308-UD
GI308	XPET 11T3AP	SCET 120408-UD
GI309	XPET 12T3AP	SCET 120408-UD
GI313	XPET 0502AP-SD	SCET 050204-SD
GI314	XPET 0602AP-SD	SCET 050204-SD
GI315	XPET 0602AP-SD	SCET 060204-SD
GI316	XPET 0703AP-SD	SCET 060204-SD
GI317	XPET 0703AP-SD	SCET 070308-SD
GI318	XPET 0903AP-SD	SCET 070308-SD
GI319	XPET 0903AP-SD	SCET 09T308-SD
GI320	XPET 11T3AP-SD	SCET 09T308-SD
GI321	XPET 11T3AP-SD	SCET 120408-SD
GI322	XPET 12T3AP-SD	SCET 120408-SD

HM001	US 2245-T07P	0.9	US 2245-T07P	0.9	FLAG T07P
HM002	US 2205-T07P	0.9	US 2245-T07P	0.9	FLAG T07P
HM003	US 2205-T07P	0.9	US 2205-T07P	0.9	FLAG T07P
HM004	US 2506-T07P	1.2	US 2506-T07P	1.2	FLAG T07P
HM005	US 2507-T08P	1.2	US 3007-T08P	2.0	FLAG T08P
HM006	US 3007-T09P	2.0	US 3007-T09P	2.0	FLAG T09P
HM007	US 3007-T09P	2.0	US 3009-T09P	2.0	FLAG T09P
HM008	US 3510-T15P	3.0	US 3508-T15P	3.0	FLAG T15P
HM009	US 3510-T15P	3.0	US 5012-T15P	5.0	FLAG T15P



803D

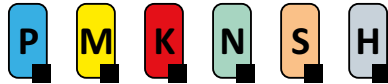

PRAMET

S



3xD 803D Indexable Insert Drill body with Internal Coolant Feed

High performance indexable insert drill body for drilling blind and through holes. Also, potentially cross hole, off center and stack drilling, helical interpolation, plunging, drilling on concave or angled surfaces, drilling with interrupted cuts, chamfer drilling and boring. Available from Ø15 up to Ø58 mm in 3xD.

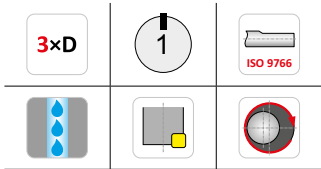
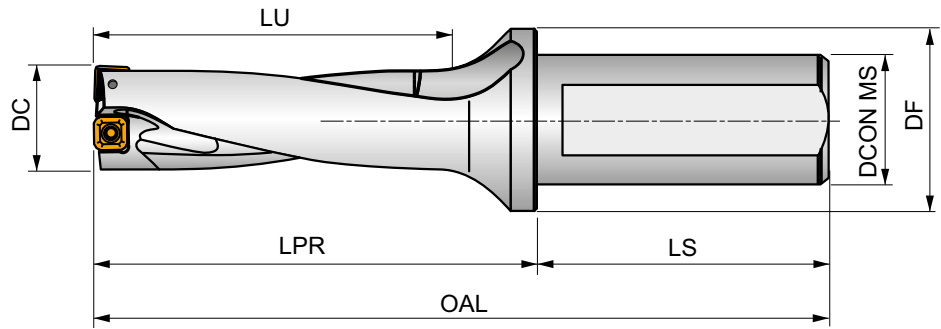

Product	DC	APMX	OAL	LPR	LS	LU	DCON MS	DF	\bar{D}	\bar{D}^+	EP	GI	GI	kg	HM
	[mm]	[mm]	[mm]	[mm]	[mm]	[mm]		[mm]	[mm]	[mm]					
803D-15-45-S25	15	45.00	136	80	56	49.5	25	35	0.25	0.35	EP253253	GI300	GI313	0.31	HM001
803D-15,5-46,5-S25	15.5	47.00	137.5	81.5	56	51.2	25	35	0.30	0.35	EP253253	GI300	GI313	0.31	HM001
803D-16-48-S25	16	48.00	139	83	56	53	25	35	0.15	0.45	EP253253	GI300	GI313	0.32	HM001
803D-16,5-49,5-S25	16.5	50.00	140.5	84.5	56	54.7	25	35	0.15	0.40	EP253253	GI300	GI313	0.32	HM001
803D-17-51-S25	17	51.00	142	86	56	56.5	25	35	0.10	0.50	EP253253	GI300	GI313	0.32	HM001
803D-17,5-52,5-S25	17.5	53.00	143.5	87.5	56	58.2	25	35	0.50	0.50	EP253253	GI301	GI314	0.32	HM002
803D-18-54-S25	18	54.00	145	89	56	60	25	35	0.35	0.25	EP253253	GI301	GI314	0.33	HM002
803D-18,5-55,5-S25	18.5	56.00	146.5	90.5	56	61.2	25	35	0.35	0.25	EP253253	GI301	GI314	0.34	HM002
803D-19-57-S25	19	57.00	148	92	56	63.5	25	35	0.15	0.45	EP253253	GI301	GI314	0.34	HM002
803D-19,5-58,5-S25	19.5	59.00	149.5	93.5	56	63.7	25	35	0.25	0.40	EP253253	GI302	GI315	0.34	HM003
803D-20-60-S25	20	60.00	151	95	56	67	25	35	0.10	0.45	EP253253	GI302	GI315	0.35	HM003
803D-20,5-61,5-S25	20.5	62.00	152.5	96.5	56	67.2	25	35	0.10	0.50	EP253253	GI302	GI315	0.36	HM003
803D-21-63-S25	21	63.00	154	98	56	70.5	25	35	0.10	0.50	EP253253	GI302	GI315	0.36	HM003
803D-21,5-64,5-S25	21.5	65.00	155.5	99.5	56	70.8	25	35	0.35	0.50	EP253253	GI303	GI316	0.37	HM004
803D-22-66-S25	22	66.00	157	101	56	74	25	35	0.45	0.50	EP253253	GI303	GI316	0.38	HM004
803D-22,5-67,5-S25	22.5	68.00	158.5	102.5	56	74.3	25	35	0.35	0.50	EP253253	GI304	GI317	0.39	HM005
803D-23-69-S25	23	69.00	160	104	56	77.5	25	35	0.35	0.50	EP253253	GI304	GI317	0.40	HM005
803D-23,5-70,5-S25	23.5	71.00	161.5	105.5	56	77.6	25	35	0.10	0.50	EP253253	GI304	GI317	0.40	HM005
803D-24-72-S25	24	72.00	163	107	56	81	25	35	0.15	0.50	EP253253	GI304	GI317	0.41	HM005
803D-24,5-73,5-S25	24.5	74.00	168.5	108.5	60	78.7	25	35	0.10	0.50	EP253253	GI304	GI317	0.42	HM005
803D-25-75-S32	25	75.00	170	110	60	82	32	42	0.15	0.50	EP324058	GI304	GI317	0.62	HM005
803D-25,5-76,5-S32	25.5	77.00	171.5	111.5	60	82.2	32	42	0.50	0.10	EP324058	GI304	GI317	0.63	HM005
803D-26-78-S32	26	78.00	173	113	60	85.5	32	42	0.10	0.50	EP324058	GI304	GI317	0.64	HM005
803D-26,5-79,5-S32	26.5	80.00	174.5	114.5	60	85.7	32	42	0.50	0.10	EP324058	GI305	GI318	0.65	HM006
803D-27-81-S32	27	81.00	176	116	60	89	32	42	0.50	0.30	EP324058	GI305	GI318	0.65	HM006
803D-28-84-S32	28	84.00	179	119	60	92.5	32	42	0.30	0.50	EP324058	GI306	GI319	0.68	HM007
803D-29-87-S32	29	87.00	182	122	60	96	32	42	0.20	0.50	EP324058	GI306	GI319	0.70	HM007



Product	DC	APMX	OAL	LPR	LS	LU	DCONIMS	DF	$\overset{-}{D}$	$\overset{+}{D}$					
	[mm]	[mm]	[mm]	[mm]	[mm]	[mm]	[mm]	[mm]	[mm]	[mm]				kg	
803D-30-90-S32	30	90.00	185	125	60	99.5	32	42	0.15	0.50	EP324058	GI306	GI319	0.73	HM007
803D-31-93-S32	31	93.00	188	128	60	103	32	42	0.15	0.50	EP324058	GI306	GI319	0.76	HM007
803D-32-96-S32	32	96.00	191	131	60	102	32	42	0.50	0.30	EP324058	GI307	GI320	0.79	HM008
803D-32-96-S40	32	96.00	199	131	68	102	40	50	0.50	0.30	–	GI307	GI320	1.14	HM008
803D-33-99-S32	33	99.00	194	134	60	105.5	32	42	0.50	0.50	EP324058	GI307	GI320	0.83	HM008
803D-33-99-S40	33	99.00	202	134	68	105.5	40	50	0.50	0.50	–	GI307	GI320	1.18	HM008
803D-34-102-S32	34	102.00	197	137	60	109	32	42	0.25	0.50	EP324058	GI307	GI320	0.86	HM008
803D-34-102-S40	34	102.00	205	137	68	109	40	50	0.25	0.50	–	GI307	GI320	1.12	HM008
803D-35-105-S32	35	105.00	200	140	60	112.5	32	42	0.25	0.50	EP324058	GI308	GI321	0.90	HM009
803D-35-105-S40	35	105.00	208	140	68	112.5	40	50	0.25	0.50	–	GI308	GI321	1.24	HM009
803D-36-108-S32	36	108.00	203	143	60	116	32	42	0.10	0.50	EP324058	GI308	GI321	0.91	HM009
803D-36-108-S40	36	108.00	211	143	68	116	40	50	0.10	0.50	–	GI308	GI321	1.25	HM009
803D-37-111-S32	37	111.00	206	146	60	119.5	32	42	0.10	0.50	EP324058	GI308	GI321	0.95	HM009
803D-37-111-S40	37	111.00	214	146	68	119.5	40	50	0.10	0.50	–	GI308	GI321	1.29	HM009
803D-38-114-S32	38	114.00	199	139	60	124.5	32	42	0.50	0.50	EP324058	GI308	GI321	1.00	HM009
803D-38-114-S40	38	114.00	217	149	68	123	40	50	0.50	0.50	–	GI308	GI321	1.34	HM009
803D-39-117-S32	38	114.00	209	149	60	123	32	42	0.40	0.50	EP324058	GI309	GI322	1.06	HM009
803D-39-117-S40	39	117.00	220	152	68	126.5	40	50	0.40	0.50	–	GI309	GI322	1.40	HM009
803D-40-120-S32	40	120.00	215	155	60	130	32	42	0.20	0.50	EP324058	GI309	GI322	1.12	HM009
803D-40-120-S40	40	120.00	223	155	68	130	40	50	0.20	0.50	–	GI309	GI322	1.46	HM009
803D-41-123-S40	41	123.00	219	149	70	133	40	50	0.20	0.50	–	GI309	GI322	1.48	HM009
803D-42-126-S40	42	126.00	221.5	152	70	136	40	50	0.15	0.50	–	GI309	GI322	1.52	HM009
803D-43-129-S40	43	129.00	224	154	70	139	40	50	0.10	0.50	–	GI309	GI322	1.58	HM009
803D-44-132-S40	44	132.00	226.5	157	70	142	40	50	0.50	0.50	–	GI310	GI323	1.63	HM010
803D-45-135-S40	45	135.00	230.5	161	70	144	40	55	0.50	0.50	–	GI311	GI324	1.73	HM010
803D-46-138-S40	46	138.00	235	165	70	148	40	55	0.50	0.50	–	GI311	GI324	1.82	HM010
803D-47-141-S40	47	141.00	237.5	168	70	151	40	55	0.50	0.50	–	GI311	GI324	1.90	HM010
803D-48-144-S40	48	144.00	240	170	70	154	40	55	0.50	0.50	–	GI311	GI324	1.98	HM010
803D-49-147-S40	49	147.00	242.5	173	70	157	40	55	0.30	0.50	–	GI311	GI324	2.06	HM010
803D-50-150-S40	50	150.00	246.5	177	70	160	40	58	0.15	0.50	–	GI311	GI324	2.18	HM010
803D-51-153-S40	51	153.00	249	179	70	163	40	58	0.15	0.50	–	GI311	GI324	2.24	HM010
803D-52-156-S40	52	156.00	251.5	182	70	166	40	58	0.50	0.50	–	GI312	GI325	2.20	HM010
803D-53-159-S40	53	159.00	254	184	70	169	40	58	0.50	0.50	–	GI312	GI325	2.29	HM010
803D-54-162-S40	54	162.00	257.5	188	70	173	40	58	0.50	0.50	–	GI312	GI325	2.39	HM010
803D-55-165-S40	55	165.00	260	190	70	176	40	58	0.50	0.50	–	GI312	GI325	2.46	HM010
803D-56-168-S40	56	168.00	264	194	70	179	40	58	0.50	0.50	–	GI312	GI325	2.59	HM010
803D-57-171-S40	57	171.00	266.5	197	70	182	40	58	0.35	0.50	–	GI312	GI325	2.70	HM010
803D-58-174-S40	58	174.00	270	200	70	186	40	58	0.15	0.50	–	GI312	GI325	2.83	HM010

GI300	XPET 0502AP	SCET 050204-UD
GI301	XPET 0602AP	SCET 050204-UD
GI302	XPET 0602AP	SCET 060204-UD
GI303	XPET 0703AP	SCET 060204-UD
GI304	XPET 0703AP	SCET 070308-UD
GI305	XPET 0903AP	SCET 070308-UD
GI306	XPET 0903AP	SCET 09T308-UD
GI307	XPET 11T3AP	SCET 09T308-UD
GI308	XPET 11T3AP	SCET 120408-UD
GI309	XPET 12T3AP	SCET 120408-UD
GI310	XPET 1504AP	SCET 120408-UD
GI311	XPET 1504AP	SCET 150512-UD
GI312	XPET 1904AP	SCET 150512-UD
GI313	XPET 0502AP-SD	SCET 050204-SD
GI314	XPET 0602AP-SD	SCET 050204-SD
GI315	XPET 0602AP-SD	SCET 060204-SD
GI316	XPET 0703AP-SD	SCET 060204-SD
GI317	XPET 0703AP-SD	SCET 070308-SD
GI318	XPET 0903AP-SD	SCET 070308-SD
GI319	XPET 0903AP-SD	SCET 09T308-SD



GI320	XPET 11T3AP-SD	SCET 09T308-SD
GI321	XPET 11T3AP-SD	SCET 120408-SD
GI322	XPET 12T3AP-SD	SCET 120408-SD
GI323	XPET 1504AP-SD	SCET 120408-SD
GI324	XPET 1504AP-SD	SCET 150512-SD
GI325	XPET 1904AP-SD	SCET 150512-SD

HM001	US 2245-T07P	0.9	US 2245-T07P	0.9	FLAG T07P
HM002	US 2205-T07P	0.9	US 2245-T07P	0.9	FLAG T07P
HM003	US 2205-T07P	0.9	US 2205-T07P	0.9	FLAG T07P
HM004	US 2506-T07P	1.2	US 2506-T07P	1.2	FLAG T07P
HM005	US 2507-T08P	1.2	US 3007-T08P	2.0	FLAG T08P
HM006	US 3007-T09P	2.0	US 3007-T09P	2.0	FLAG T09P
HM007	US 3007-T09P	2.0	US 3009-T09P	2.0	FLAG T09P
HM008	US 3510-T15P	3.0	US 3508-T15P	3.0	FLAG T15P
HM009	US 3510-T15P	3.0	US 5012-T15P	5.0	FLAG T15P
HM010	US 4011-T15P	3.5	US 5012-T15P	5.0	FLAG T15P



804D

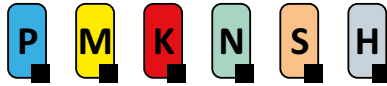

PRAMET

S



4xD 804D Indexable Insert Drill body with Internal Coolant Feed

High performance indexable insert drill body for drilling blind and through holes. Also, potentially cross hole, off center and stack drilling, helical interpolation, plunging, drilling on concave or angled surfaces, drilling with interrupted cuts, chamfer drilling and boring. Available from Ø17 up to Ø58 mm in 4xD.

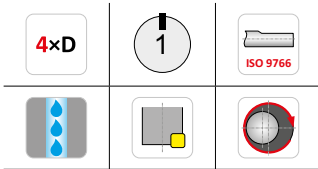
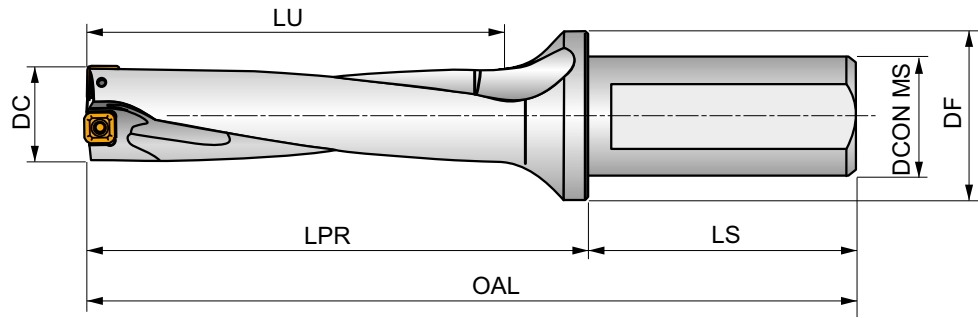

Product	DC	APMX	OAL	LPR	LS	LU	DCON MS	DF	\bar{D}	D^+					
	[mm]	[mm]	[mm]	[mm]	[mm]	[mm]	[mm]	[mm]	[mm]	[mm]				kg	
804D-17-68-S25	17	68.00	149	93	56	73	25	35	0.10	0.50	–	GI300	GI313	0.34	HM001
804D-18-72-S25	18	72.00	153	97	56	77	25	35	0.35	0.25	–	GI301	GI314	0.35	HM002
804D-19-76-S25	19	76.00	157	101	56	81.5	25	35	0.15	0.45	–	GI301	GI314	0.36	HM002
804D-20-80-S25	20	80.00	161	105	56	85	25	35	0.10	0.45	–	GI302	GI315	0.37	HM003
804D-21-84-S25	21	84.00	165	109	56	89.5	25	35	0.10	0.50	–	GI302	GI315	0.39	HM003
804D-22-88-S25	22	88.00	169	113	56	94	25	35	0.45	0.50	–	GI303	GI316	0.41	HM004
804D-23-92-S25	23	92.00	173	117	56	98.5	25	35	0.35	0.50	–	GI304	GI317	0.44	HM005
804D-24-96-S25	24	96.00	177	121	56	103	25	35	0.15	0.50	–	GI304	GI317	0.45	HM005
804D-25-100-S32	25	100.00	185	125	60	105	32	42	0.15	0.50	–	GI304	GI317	0.67	HM005
804D-26-104-S32	26	104.00	189	129	60	109.5	32	42	0.10	0.50	–	GI304	GI317	0.70	HM005
804D-27-108-S32	27	108.00	193	133	60	114	32	42	0.50	0.30	–	GI305	GI318	0.71	HM006
804D-28-112-S32	28	112.00	197	137	60	118.5	32	42	0.30	0.50	–	GI306	GI319	0.75	HM007
804D-29-116-S32	29	116.00	201	141	60	123	32	42	0.20	0.50	–	GI306	GI319	0.78	HM007
804D-30-120-S32	30	120.00	205	145	60	127.5	32	42	0.15	0.50	–	GI306	GI319	0.82	HM007
804D-31-124-S32	31	124.00	209	149	60	132	32	42	0.15	0.50	–	GI306	GI319	0.85	HM007
804D-32-128-S32	32	128.00	213	153	60	136.5	32	42	0.50	0.30	–	GI307	GI320	0.90	HM008
804D-33-132-S32	33	132.00	217	157	60	141	32	42	0.50	0.50	–	GI307	GI320	0.95	HM008
804D-34-136-S32	34	136.00	221	161	60	145.5	32	42	0.25	0.50	–	GI307	GI320	0.99	HM008
804D-35-140-S32	35	140.00	225	165	60	149	32	42	0.25	0.50	–	GI308	GI321	1.04	HM009
804D-36-144-S32	36	144.00	229	169	60	153.5	32	42	0.10	0.50	–	GI308	GI321	1.05	HM009
804D-37-148-S32	37	148.00	233	173	60	158	32	42	0.10	0.50	–	GI308	GI321	1.11	HM009
804D-38-152-S32	38	152.00	237	177	60	162.5	32	42	0.50	0.50	–	GI308	GI321	1.18	HM009
804D-39-156-S32	39	156.00	241	181	60	167	32	42	0.40	0.50	–	GI309	GI322	1.25	HM009
804D-40-160-S32	40	160.00	245	185	60	171.5	32	42	0.20	0.50	–	GI309	GI322	1.33	HM009
804D-41-164-S40	41	164.00	259	189	70	172	40	50	0.20	0.50	–	GI309	GI322	1.68	HM009
804D-42-168-S40	42	168.00	263	193	70	176.5	40	50	0.15	0.50	–	GI309	GI322	1.76	HM009
804D-43-172-S40	43	172.00	267	197	70	181	40	50	0.10	0.50	–	GI309	GI322	1.83	HM009



Product	DC	APMX	OAL	LPR	LS	LU	DCON/MS	DF	$\overset{\uparrow}{\downarrow}D$	D^{\uparrow}					
	[mm]	[mm]	[mm]	[mm]	[mm]	[mm]	[mm]	[mm]	[mm]	[mm]					
804D-44-176-S40	44	176.00	271	201	70	185.5	40	50	0.50	0.50	–	GI310	GI323	1.91	HM010
804D-45-180-S40	45	180.00	275	205	70	187.5	40	55	0.50	0.50	–	GI311	GI324	2.02	HM010
804D-46-184-S40	46	184.00	279	209	70	192	40	55	0.50	0.50	–	GI311	GI324	2.12	HM010
804D-47-188-S40	47	188.00	283	213	70	196.5	40	55	0.50	0.50	–	GI311	GI324	2.22	HM010
804D-48-192-S40	48	192.00	287	217	70	201	40	55	0.50	0.50	–	GI311	GI324	2.33	HM010
804D-49-196-S40	49	196.00	291	221	70	205.5	40	55	0.30	0.50	–	GI311	GI324	2.45	HM010
804D-50-200-S40	50	200.00	295	225	70	208.5	40	58	0.15	0.50	–	GI311	GI324	2.58	HM010
804D-51-204-S40	51	204.00	299	229	70	213	40	58	0.15	0.50	–	GI311	GI324	2.68	HM010
804D-52-208-S40	52	208.00	303	233	70	217.5	40	58	0.50	0.50	–	GI312	GI325	2.64	HM010
804D-53-212-S40	53	212.00	307	237	70	222	40	58	0.50	0.50	–	GI312	GI325	2.76	HM010
804D-54-216-S40	54	216.00	311	241	70	226.5	40	58	0.50	0.50	–	GI312	GI325	2.90	HM010
804D-55-220-S40	55	220.00	315	245	70	231	40	58	0.50	0.50	–	GI312	GI325	3.00	HM010
804D-56-224-S40	56	224.00	319	249	70	235.5	40	58	0.50	0.50	–	GI312	GI325	3.15	HM010
804D-57-228-S40	57	228.00	323	253	70	240	40	58	0.35	0.50	–	GI312	GI325	3.30	HM010
804D-58-232-S40	58	232.00	327	257	70	244.5	40	58	0.15	0.50	–	GI312	GI325	3.46	HM010

GI300	XPET 0502AP	SCET 050204-UD
GI301	XPET 0602AP	SCET 050204-UD
GI302	XPET 0602AP	SCET 060204-UD
GI303	XPET 0703AP	SCET 060204-UD
GI304	XPET 0703AP	SCET 070308-UD
GI305	XPET 0903AP	SCET 070308-UD
GI306	XPET 0903AP	SCET 09T308-UD
GI307	XPET 11T3AP	SCET 09T308-UD
GI308	XPET 11T3AP	SCET 120408-UD
GI309	XPET 12T3AP	SCET 120408-UD
GI310	XPET 1504AP	SCET 120408-UD
GI311	XPET 1504AP	SCET 150512-UD
GI312	XPET 1904AP	SCET 150512-UD
GI313	XPET 0502AP-SD	SCET 050204-SD
GI314	XPET 0602AP-SD	SCET 050204-SD
GI315	XPET 0602AP-SD	SCET 060204-SD
GI316	XPET 0703AP-SD	SCET 060204-SD
GI317	XPET 0703AP-SD	SCET 070308-SD
GI318	XPET 0903AP-SD	SCET 070308-SD
GI319	XPET 0903AP-SD	SCET 09T308-SD
GI320	XPET 11T3AP-SD	SCET 09T308-SD
GI321	XPET 11T3AP-SD	SCET 120408-SD
GI322	XPET 12T3AP-SD	SCET 120408-SD
GI323	XPET 1504AP-SD	SCET 120408-SD
GI324	XPET 1504AP-SD	SCET 150512-SD
GI325	XPET 1904AP-SD	SCET 150512-SD

HM001	US 2245-T07P	0.9	US 2245-T07P	0.9	FLAG T07P
HM002	US 2205-T07P	0.9	US 2245-T07P	0.9	FLAG T07P
HM003	US 2205-T07P	0.9	US 2205-T07P	0.9	FLAG T07P
HM004	US 2506-T07P	1.2	US 2506-T07P	1.2	FLAG T07P
HM005	US 2507-T08P	1.2	US 3007-T08P	2.0	FLAG T08P
HM006	US 3007-T09P	2.0	US 3007-T09P	2.0	FLAG T09P
HM007	US 3007-T09P	2.0	US 3009-T09P	2.0	FLAG T09P
HM008	US 3510-T15P	3.0	US 3508-T15P	3.0	FLAG T15P
HM009	US 3510-T15P	3.0	US 5012-T15P	5.0	FLAG T15P
HM010	US 4011-T15P	3.5	US 5012-T15P	5.0	FLAG T15P



805D



PRAMET

S



5xD 805D Indexable Insert Drill body with Internal Coolant Feed

High performance indexable insert drill body for drilling blind and through holes. Also, potentially cross hole, off center and stack drilling, helical interpolation, plunging, drilling on concave or angled surfaces, drilling with interrupted cuts, chamfer drilling and boring. Available from Ø19 up to Ø31 mm in 5xD.

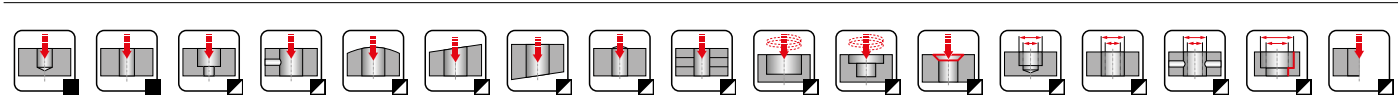
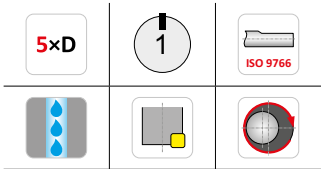
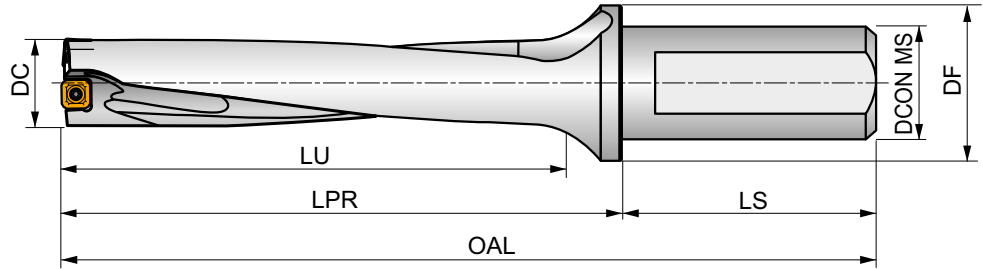

Product	DC	APMX	OAL	LPR	LS	LU	DCON MS	DF	\bar{D}	D^+				kg	
	[mm]	[mm]	[mm]	[mm]	[mm]	[mm]	[mm]	[mm]	[mm]	[mm]					
805D-19-95-S25	19	95.00	176	120	56	100.5	25	35	0.15	0.45	–	GI301	GI314	0.38	HM002
805D-20-100-S25	20	100.00	181	125	56	105	25	35	0.10	0.45	–	GI302	GI315	0.40	HM003
805D-21-105-S25	21	105.00	186	130	56	110.5	25	35	0.10	0.50	–	GI302	GI315	0.42	HM003
805D-22-110-S25	22	110.00	191	135	56	116	25	35	0.45	0.50	–	GI303	GI316	0.45	HM004
805D-23-115-S25	23	115.00	196	140	56	121.5	25	35	0.35	0.50	–	GI304	GI317	0.48	HM005
805D-24-120-S25	24	120.00	201	145	56	127	25	35	0.15	0.50	–	GI304	GI317	0.49	HM005
805D-25-125-S32	25	125.00	210	150	60	130	32	42	0.15	0.50	–	GI304	GI317	0.72	HM005
805D-26-130-S32	26	130.00	215	155	60	135.5	32	42	0.10	0.50	–	GI304	GI317	0.75	HM005
805D-27-135-S32	27	135.00	220	160	60	141	32	42	0.50	0.30	–	GI305	GI318	0.78	HM006
805D-28-140-S32	28	140.00	225	165	60	146.5	32	42	0.30	0.50	–	GI306	GI319	0.82	HM007
805D-29-145-S32	29	145.00	230	170	60	152	32	42	0.20	0.50	–	GI306	GI319	0.86	HM007
805D-30-150-S32	30	150.00	235	175	60	157.5	32	42	0.15	0.50	–	GI306	GI319	0.90	HM007
805D-31-155-S32	31	155.00	240	180	60	163	32	42	0.15	0.50	–	GI306	GI319	0.95	HM007

GI301	XPET 0602AP	SCET 050204-UD
GI302	XPET 0602AP	SCET 060204-UD
GI303	XPET 0703AP	SCET 060204-UD
GI304	XPET 0703AP	SCET 070308-UD
GI305	XPET 0903AP	SCET 070308-UD
GI306	XPET 0903AP	SCET 09T308-UD
GI314	XPET 0602AP-SD	SCET 050204-SD
GI315	XPET 0602AP-SD	SCET 060204-SD
GI316	XPET 0703AP-SD	SCET 060204-SD
GI317	XPET 0703AP-SD	SCET 070308-SD
GI318	XPET 0903AP-SD	SCET 070308-SD



GI319

XPET 0903AP-SD

SCET 09T308-SD



HM002

US 2205-T07P

0.9

US 2245-T07P

0.9

FLAG T07P

HM003

US 2205-T07P

0.9

US 2205-T07P

0.9

FLAG T07P

HM004

US 2506-T07P

1.2

US 2506-T07P

1.2

FLAG T07P

HM005

US 2507-T08P

1.2

US 3007-T08P

2.0

FLAG T08P

HM006

US 3007-T09P

2.0

US 3007-T09P

2.0

FLAG T09P

HM007

US 3007-T09P

2.0

US 3009-T09P

2.0

FLAG T09P



EP



EP - Indexable Insert Drill Adjustment Sleeve

Sleeve to adjust indexable insert drill diameter. Can be used in Ø32 or Ø40 mm weldon tool holders. The outside drill diameter is adjusted by rotating the sleeve.

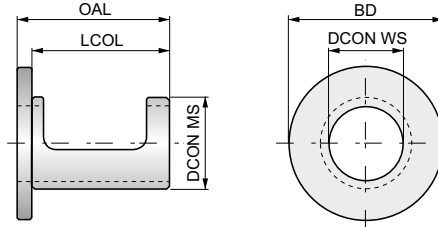

Diameter adjustment range is 0.4 – -0.2; center height adjustment range is 0.2 – -0.15.

Product	DCON WS [mm]	DCON MS [mm]	BD [mm]	OAL [mm]	LCOL [mm]	
EP253253	25.00	32.00	53.00	53.0	48	0.15
EP324058	32.00	40.00	58.00	58.0	53	0.20



SCET

	IC	D1	L	S
	[mm]	[mm]	[mm]	[mm]
0502	5.556	2.40	5.56	2.38
0602	6.350	2.90	6.35	2.38
0703	7.937	3.50	7.94	3.18
09T3	9.525	4.50	9.53	3.97
1204	12.700	5.60	12.70	4.76
1505	15.875	5.60	15.88	5.56

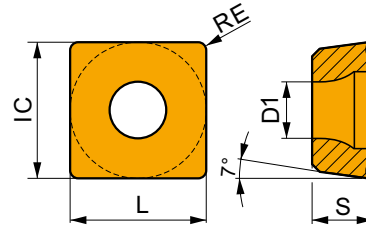

Suitability and starting values for cutting speed (vc), feed (f) and depth of cut (ap). Refer to our Machining Calculator app for further calculations.

Product	RE	P			M			K			N			S			H		
		vc	f	ap	vc	f	ap	vc	f	ap	vc	f	ap	vc	f	ap			
	[mm]	[m/min]	[mm/rev]	[mm]	[m/min]	[mm/rev]	[mm]	[m/min]	[mm/rev]	[mm]	[m/min]	[mm/rev]	[mm]	[m/min]	[mm/rev]	[mm]	[m/min]	[mm/rev]	[mm]

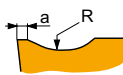

UD geometry with universal design for periphery inserts.

SCET 050204-UD 0,12
 SCET 060204-UD 0,15
 SCET 070308-UD 0,15
 SCET 09T308-UD 0,15
 SCET 120408-UD 0,20
 SCET 150512-UD 0,20

SCET 050204-UD	D8330	0.4	165	0.08	—	—	—	—	155	0.08	—	—	—	—	—	—	—	—	—
	D9335	0.4	240	0.08	—	—	—	—	225	0.08	—	—	—	—	—	—	—	—	—
SCET 060204-UD	D8330	0.4	165	0.11	—	—	—	—	155	0.11	—	—	—	—	—	—	—	—	—
	D9335	0.4	240	0.11	—	—	—	—	225	0.11	—	—	—	—	—	—	—	—	—
SCET 070308-UD	D8330	0.8	165	0.13	—	—	—	—	155	0.13	—	—	—	—	—	—	—	—	—
	D9335	0.8	240	0.13	—	—	—	—	225	0.13	—	—	—	—	—	—	—	—	—
SCET 09T308-UD	D8330	0.8	165	0.14	—	—	—	—	155	0.14	—	—	—	—	—	—	—	—	—
	D9335	0.8	240	0.14	—	—	—	—	225	0.14	—	—	—	—	—	—	—	—	—
SCET 120408-UD	D8330	0.8	165	0.16	—	—	—	—	155	0.16	—	—	—	—	—	—	—	—	—
	D9335	0.8	240	0.16	—	—	—	—	225	0.16	—	—	—	—	—	—	—	—	—
SCET 150512-UD	D8330	1.2	165	0.18	—	—	—	—	155	0.18	—	—	—	—	—	—	—	—	—
	D9335	1.2	240	0.18	—	—	—	—	225	0.18	—	—	—	—	—	—	—	—	—

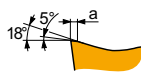

SD geometry with positive design for periphery inserts.

SCET 050204-SD 0,04
 SCET 060204-SD 0,06
 SCET 070308-SD 0,08
 SCET 09T308-SD 0,10
 SCET 120408-SD 0,10
 SCET 150512-SD 0,10

SCET 050204-SD	D8330	0.4	165	0.08	—	95	0.07	—	155	0.08	—	—	—	—	40	0.06	—	—	—
	D9335	0.4	240	0.08	—	140	0.07	—	225	0.08	—	—	—	—	60	0.06	—	—	—
SCET 060204-SD	D8330	0.4	165	0.11	—	95	0.09	—	155	0.11	—	—	—	—	40	0.07	—	—	—
	D9335	0.4	240	0.11	—	140	0.09	—	225	0.11	—	—	—	—	60	0.07	—	—	—
SCET 070308-SD	D8330	0.8	165	0.13	—	95	0.11	—	155	0.13	—	—	—	—	40	0.09	—	—	—
	D9335	0.8	240	0.13	—	140	0.11	—	225	0.13	—	—	—	—	60	0.09	—	—	—
SCET 09T308-SD	D8330	0.8	165	0.14	—	95	0.13	—	155	0.14	—	—	—	—	40	0.10	—	—	—
	D9335	0.8	240	0.14	—	140	0.13	—	225	0.14	—	—	—	—	60	0.10	—	—	—
SCET 120408-SD	D8330	0.8	165	0.16	—	95	0.14	—	155	0.16	—	—	—	—	40	0.11	—	—	—
	D9335	0.8	240	0.16	—	140	0.14	—	225	0.16	—	—	—	—	60	0.11	—	—	—
SCET 150512-SD	D8330	1.2	165	0.18	—	95	0.16	—	155	0.18	—	—	—	—	40	0.12	—	—	—
	D9335	1.2	240	0.18	—	140	0.16	—	225	0.18	—	—	—	—	60	0.12	—	—	—



XPET



IC	D1	L	S	
				[mm]
0502	5.556	2.40	5.56	2.38
0602	6.350	2.60	6.35	2.38
0703	7.937	2.90	7.94	3.18
0903	9.525	3.50	9.53	3.18
11T3	11.509	3.90	11.50	3.97
12T3	12.700	3.90	12.70	3.97
1504	15.875	4.50	15.88	4.76
1904	19.050	4.50	19.05	4.76

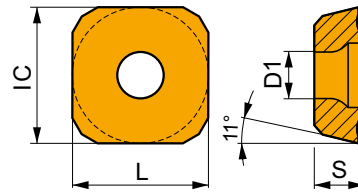

Suitability and starting values for cutting speed (vc), feed (f) and depth of cut (ap). Refer to our Machining Calculator app for further calculations.

Product	RE [mm]	P			M			K			N			S			H		
		vc [m/min]	f [mm/rev]	ap [mm]	vc [m/min]	f [mm/rev]	ap [mm]	vc [m/min]	f [mm/rev]	ap [mm]	vc [m/min]	f [mm/rev]	ap [mm]	vc [m/min]	f [mm/rev]	ap [mm]	vc [m/min]	f [mm/rev]	ap [mm]

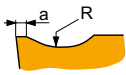

Product	a
XPET 0502AP	0,10
XPET 0602AP	0,10
XPET 0703AP	0,15
XPET 0903AP	0,25
XPET 11T3AP	0,25
XPET 12T3AP	0,25
XPET 1504AP	0,25
XPET 1904AP	0,25

Geometry with universal design for central inserts.

XPET 0502AP	D8345	—	■	165	0.08	—	—	—	—	■	155	0.08	—	—	—	—	—	—	—
XPET 0602AP	D8345	—	■	165	0.11	—	—	—	—	■	155	0.11	—	—	—	—	—	—	—
XPET 0703AP	D8345	—	■	165	0.13	—	—	—	—	■	155	0.13	—	—	—	—	—	—	—
XPET 0903AP	D8345	—	■	165	0.14	—	—	—	—	■	155	0.14	—	—	—	—	—	—	—
XPET 11T3AP	D8345	—	■	165	0.16	—	—	—	—	■	155	0.16	—	—	—	—	—	—	—
XPET 12T3AP	D8345	—	■	165	0.16	—	—	—	—	■	155	0.16	—	—	—	—	—	—	—
XPET 1504AP	D8345	—	■	165	0.18	—	—	—	—	■	155	0.18	—	—	—	—	—	—	—
XPET 1904AP	D8345	—	■	165	0.18	—	—	—	—	■	155	0.18	—	—	—	—	—	—	—

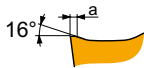

Product	a
XPET 0502AP-SD	0,04
XPET 0602AP-SD	0,05
XPET 0703AP-SD	0,08
XPET 0903AP-SD	0,10
XPET 11T3AP-SD	0,10
XPET 12T3AP-SD	0,10
XPET 1504AP-SD	0,10
XPET 1904AP-SD	0,12

SD geometry with positive design for central inserts.

XPET 0502AP-SD	D8345	—	■	165	0.08	—	■	95	0.07	—	■	155	0.08	—	—	—	■	40	0.06	—	—	—	—
XPET 0602AP-SD	D8345	—	■	165	0.11	—	■	95	0.09	—	■	155	0.11	—	—	—	■	40	0.07	—	—	—	—
XPET 0703AP-SD	D8345	—	■	165	0.13	—	■	95	0.11	—	■	155	0.13	—	—	—	■	40	0.09	—	—	—	—
XPET 0903AP-SD	D8345	—	■	165	0.14	—	■	95	0.13	—	■	155	0.14	—	—	—	■	40	0.10	—	—	—	—
XPET 11T3AP-SD	D8345	—	■	165	0.16	—	■	95	0.14	—	■	155	0.16	—	—	—	■	40	0.11	—	—	—	—
XPET 12T3AP-SD	D8345	—	■	165	0.16	—	■	95	0.14	—	■	155	0.16	—	—	—	■	40	0.11	—	—	—	—
XPET 1504AP-SD	D8345	—	■	165	0.18	—	■	95	0.16	—	■	155	0.18	—	—	—	■	40	0.12	—	—	—	—
XPET 1904AP-SD	D8345	—	■	165	0.18	—	■	95	0.16	—	■	155	0.18	—	—	—	■	40	0.12	—	—	—	—



WCMT-ID

	IC	D1	L	S
	[mm]	[mm]	[mm]	[mm]
0402	6.350	2.90	4.30	2.38
0503	7.938	3.50	5.40	3.18
06T3	9.525	4.40	6.50	3.97
0804	12.700	5.50	8.70	4.76

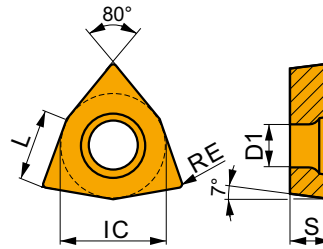

Suitability and starting values for cutting speed (vc), feed (f) and depth of cut (ap). Refer to our Machining Calculator app for further calculations.

Product	RE	P			M			K			N			S			H		
		vc	f	ap	vc	f	ap	vc	f	ap	vc	f	ap	vc	f	ap	vc	f	ap
	[mm]	[m/min]	[mm/rev]	[mm]	[m/min]	[mm/rev]	[mm]	[m/min]	[mm/rev]	[mm]	[m/min]	[mm/rev]	[mm]	[m/min]	[mm/rev]	[mm]	[m/min]	[mm/rev]	[mm]
 Geometry 45 for finish to rough machining, and continuous to interrupted cuts.	D8330	0.8	165	0.15	-	95	0.14	-	155	0.15	-	-	-	-	-	-	-	-	-
 Geometry 46 for fine to finish machining, and continuous to interrupted cuts.	D8330	0.8	165	0.15	-	95	0.14	-	155	0.15	-	-	-	-	-	-	-	-	-
 Geometry 47 for finish to semi-rough machining, and continuous to interrupted cuts.	D8330	0.8	165	0.20	-	95	0.18	-	155	0.20	-	-	-	-	-	-	-	-	-
 Geometry 48 for finish to semi-rough machining, and continuous to interrupted cuts.	D8330	1.2	165	0.22	-	95	0.22	-	155	0.22	-	-	-	-	-	-	-	-	-
 Geometry UM for finish to semi-rough machining, and continuous to slightly interrupted cuts.	D8330	0.8	165	0.20	-	95	0.18	-	155	0.20	-	-	-	-	-	-	-	-	-
 Geometry UM for finish to semi-rough machining, and continuous to slightly interrupted cuts.	D8330	0.8	165	0.20	-	95	0.18	-	155	0.20	-	-	-	-	-	-	-	-	-



WCMX



	IC	D1	L	S
	[mm]	[mm]	[mm]	[mm]
0302	5.556	2.85	3.80	2.38
0402	6.350	3.15	4.30	2.38
0503	7.938	3.20	5.40	3.18
06T3	9.525	3.72	6.50	3.97
0804	12.700	4.30	8.70	4.76

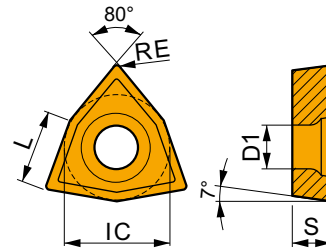

Suitability and starting values for cutting speed (vc), feed (f) and depth of cut (ap). Refer to our Machining Calculator app for further calculations.

Product	RE	P			M			K			N			S			H		
		vc	f	ap	vc	f	ap	vc	f	ap	vc	f	ap	vc	f	ap	vc	f	ap
	[mm]	[m/min]	[mm/rev]	[mm]	[m/min]	[mm/rev]	[mm]	[m/min]	[mm/rev]	[mm]	[m/min]	[mm/rev]	[mm]	[m/min]	[mm/rev]	[mm]	[m/min]	[mm/rev]	[mm]
				Geometry 45 for finish to rough machining, and continuous to interrupted cuts.															
WCMX 06T308E-45	D8330	0.8	165	0.15	95	0.14	155	0.15	-	-	-	-	-	-	-	-	-	-	-
				Geometry 46 for fine to finish machining, and continuous to interrupted cuts.															
WCMX 030208E-46	D8330	0.8	165	0.15	95	0.14	155	0.15	-	-	-	-	-	-	-	-	-	-	-
WCMX 040208E-46	D8330	0.8	165	0.15	95	0.14	155	0.15	-	-	-	-	-	-	-	-	-	-	-
				Geometry 47 for finish to semi-rough machining, and continuous to interrupted cuts.															
WCMX 050308E-47	D8330	0.8	165	0.20	95	0.18	155	0.20	-	-	-	-	-	-	-	-	-	-	-
				Geometry 48 for finish to semi-rough machining, and continuous to interrupted cuts.															
WCMX 080412E-48	D8330	1.2	165	0.22	95	0.20	155	0.22	-	-	-	-	-	-	-	-	-	-	-



INDEXABLE DRILLS
TECHNICAL INFORMATION



WORKPIECE MATERIAL GROUP (WMG)

ISO To select a cutting grade and geometry for a broad range of workpiece materials

General definition
i.e. Steel, Stainless Steel...

P **M** **K** **N** **S** **H**

Subgroup To navigate and select a tool by suitability for a more specific range of workpiece materials

Definition by structure/composition
i.e. Plain Carbon Steel, Alloy Steel...

P **M** **K** **N** **S** **H**

P1

P2

P3

P4

WMG To select and provide cutting conditions within a bandwidth of $\pm 10\%$

Definition by hardness/ultimate tensile strength
i.e. $160 < 220$ HB, $620 < 900$ N/mm² ...

P

P1 **P1.1** **P1.2** **P1.3**

P2 **P2.1** **P2.2** **P2.3**

P3 **P3.1** **P3.2** **P3.3**

P4 **P4.1** **P4.2** **P4.3**

ABOUT DORMER PRAMET'S WORKPIECE MATERIAL CLASSIFICATION

Workpiece **Material Groups (WMG)** are used to support easy and reliable selection of the right cutting tool and starting values for machining conditions in particular applications.

Dormer Pramet classifies workpiece materials into six different coloured groups;

- **Blue:** Steel and cast steel (P-group)
- **Yellow:** Stainless steel (M-group)
- **Red:** Cast iron (K-group)
- **Green:** Non-ferrous metals (N-group)
- **Brown:** High-temperature alloys (S-group)
- **Grey:** Hardened materials (H-group)

Each of these are divided into subgroups on the basis of their structure and/or composition. For example, P-group steel and cast steel is split into four subgroups, namely;

- **P1** – Free machining steel
- **P2** – Plain carbon steel
- **P3** – Alloy steel
- **P4** – Tool steel

A final division includes material properties, such as hardness and ultimate tensile strength. This is to provide our customers with a complete tool recommendation, including starting values for cutting speed and feed.

The table on the next page includes a description of each workpiece material group, as well as examples of commonly used designations.

WORKPIECE MATERIAL GROUP (WMG)

ISO group	Subgroup	WMG (Work Material Group)	k_{vc}	Examples of material (AISI, EN, DIN, ČSN, GB, SS, STN, BS, UNE, AFNOR, ASTM, GOST, UNS, UNI, ...)
P Steel and cast steel (steels with alloy content ≤ 10 % and a hardness of < 45HRC)	P1 Free machining steel (carbon steels with increased machinability)	P1.1 Free machining sulfurized carbon steel with a hardness of < 220 HB	1.33	AISI 1108, EN 15522, DIN 1.0723, SS 1922, ČSN 11120, BS 210A15, UNE F.210F, GB Y15, AFNOR 10F1, GOST A30, UNI CF10S20
		P1.2 Free machining sulfurized and phosphorized carbon steel with a hardness of < 180 HB	1.49	AISI 1211, EN 115Mn30, DIN 1.0715, SS 1912, ČSN 11109, BS 230M7, UNE F.2111, GB Y15, AFNOR S250, GOST A40G, UNI CF95Mn28
		P1.3 Free machining sulfurized/phosphorized and leaded carbon steel with a hardness of < 160 HB	1.53	AISI 12L13, EN 115MnPb30, DIN 1.0718, SS 1914, ČSN 12110, BS 210M16, UNE F.2114, GB Y15Pb, AFNOR S250Pb, GOST A35G2, UNI CF10SPb20
	P2 Plain carbon steel (steels comprised of mainly iron and carbon)	P2.1 Plain low carbon steel containing < 0.25 % C with a hardness of < 180 HB	1.14	AISI 1015, EN C15, DIN 1.0401, SS 1350, ČSN 11301, BS 080A15, UNE F.111, GB 15, AFNOR C18RR, GOST S22ps, UNI Fe360
		P2.2 Plain medium carbon steel containing < 0.55 % C with a hardness of < 240 HB	1.00	AISI 1030, EN C30, DIN 1.0528, SS 1550, ČSN 12031, BS 080M32, UNE F.1130, GB 30, AFNOR AF50C30, GOST 30G, UNI Fe590
		P2.3 Plain high carbon steel containing > 0.55 % C, with a hardness of < 300 HB	0.89	AISI 1060, EN C60, DIN 1.0601, SS 1655, ČSN 12061, BS 080A62, UNE F.513, GB 60, AFNOR 1C60, GOST 60G, UNI C60
	P3 Alloy steel (carbon steels with an alloying content ≤ 10 %)	P3.1 Alloy steel with a hardness of < 180 HB	0.92	AISI 5015, EN 16Mo3, DIN 1.5415, SS 2912, ČSN 15020, BS 1501-240, UNE F.2601, GB 16Mo, AFNOR 15D3, GOST 15M, UNI 16Mo3KW
		P3.2 Alloy steel with a hardness of 180 – 260 HB	0.74	AISI 4140, EN 42CrMo4, DIN 1.7225, SS 2244, ČSN 15142, BS 708M40, UNE F.8232, GB 42CrMo, AFNOR 42CD4, GOST 40CHFA, UNI 42CrMo4
		P3.3 Alloy steel with a hardness of 260 – 360 HB	0.63	AISI 4140, EN 42CrMo4, DIN 1.7225, SS 2244, ČSN 15142, BS 708M40, UNE F.8232, GB 42CrMo, AFNOR 42CD4, GOST 40CHFA, UNI 42CrMo4
	P4 Tool steel (special alloy steel for tools, dies and molds)	P4.1 Tool steel with a hardness of < 26 HRC	0.55	AISI D2, EN X155CrVMo12-1, DIN 1.2370, SS 2736, ČSN 19573, BS BD2, UNE F.520A, GB Cr12Mo1V1, AFNOR Z160CDV12, GOST Ch12MF, UNI X155CrVMo121KU
		P4.2 Tool steel with a hardness of 26 – 39 HRC	0.47	AISI D2, EN X155CrVMo12-1, DIN 1.2370, SS 2736, ČSN 19573, BS BD2, UNE F.520A, GB Cr12Mo1V1, AFNOR Z160CDV12, GOST Ch12MF, UNI X155CrVMo121KU
		P4.3 Tool steel with a hardness of 39 – 45 HRC	0.38	AISI D2, EN X155CrVMo12-1, DIN 1.2370, SS 2736, ČSN 19573, BS BD2, UNE F.520A, GB Cr12Mo1V1, AFNOR Z160CDV12, GOST Ch12MF, UNI X155CrVMo121KU

WORKPIECE MATERIAL GROUP (WMG)



ISO group	Subgroup	WMG (Work Material Group)	k _{vc}	Examples of material (AISI, EN, DIN, ČSN, GB, SS, STN, BS, UNE, AFNOR, ASTM, GOST, UNS, UNI, ...)
M Stainless steel (corrosion resistant steels with ≥ 11 % chromium content)	M1 Ferritic stainless steel (straight chromium non-hardenable alloys)	M1.1	Stainless steel, ferritic with a hardness of < 160 HB	1.22 AISI 5429, EN X7Cr14, DIN 1.4001, SS 2326, BS 434517, UNE F.3401, AFNOR Z8C12, GOST 08Ch13, UNI X6CrTi12
		M1.2	Stainless steel, ferritic with a hardness of 160 – 220 HB	1.03 AISI 446, EN X10CrAl24, DIN 1.4762, SS 2322, ČSN 17113, BS 430517, UNE F.3154, GB 10Cr17, AFNOR Z10CA524, GOST 12Ch17, UNI X16Cr26
		M2.1	Stainless steel, martensitic with a hardness of < 200 HB	1.08 AISI 430F, EN X14CrMo517, DIN 1.4104, SS 2383, ČSN 17140, BS 410S21, UNE F.3117, AFNOR Z10CF17, UNI X10Cr517
	M2 Martensitic stainless steel (straight chromium hardenable alloys)	M2.2	Stainless steel, martensitic with a hardness of 200 – 280 HB	0.89 AISI 440C, EN X105CrMo17, DIN 1.4125, SS 2385, ČSN 17023, BS 425C11, UNE F.3402, GB 102Cr17Mo, AFNOR Z100CD17, GOST 95Ch18, UNI 6X6CrNi 13 04
		M2.3	Stainless steel, martensitic with a hardness of 280 – 380 HB	0.75 AISI 420, EN X45Cr13, DIN 1.4034, ČSN 17029, BS 425C11, UNE F.3405, AFNOR Z44C14, GOST 20X17H12, UNI X30Cr13
		M3.1	Stainless steel, austenitic with a hardness of < 200 HB	1.00 AISI 304, EN X5CrNi18-12, DIN 1.4303, SS 2352, ČSN 17249, BS 305S17, UNE F.3513, GB 10Cr18Ni12, AFNOR Z8CN18.12, UNI X7CrNi18 10
	M3 Austenitic stainless steel (chromium-nickel and chromium-nickel-manganese alloys)	M3.2	Stainless steel, austenitic with a hardness of 200 – 260 HB	0.86 AISI 309, EN X15CrNiSi20-12, DIN 1.4828, ČSN 17251, BS 309S24, UNE F.3312, GB 1G23Ni13, AFNOR Z15CNS20.12, GOST 20Ch20Ni452, UNI 16CrNi23 14
		M3.3	Stainless steel, austenitic with a hardness of 260 – 300 HB	0.77 AISI 5848, EN X45CrNiW18-9, DIN 1.4873, BS 331540, UNE F.3211, AFNOR Z35CNW514-4, UNI X45CrNiW 18 9
		M4.1	Stainless steel, austenitic-ferritic or super-austenitic with a hardness of < 300 HB	0.75 AISI 329, EN X1-NiCrMoCu25-20-5, DIN 1.4539, SS 2562, ČSN 17265, BS 318513, UNE F.3552, GB 022Cr25NiMo2N, AFNOR Z1NCUD25.20
	M4 Super-austenitic, Duplex or Precipitation Hardening stainless steel (austenitic alloys with > 20 % Ni, austenitic-ferritic microstructure or precipitation hardened)	M4.2	Stainless steel, precipitation hardening austenitic with a hardness of 300 – 380 HB	0.64 AISI 631 (17-7PH), EN X7CrNiAl17-7, DIN 1.4568, SS 2388, ČSN 17465, BS 301513, UNE F.3217, GB 07Cr17Ni7Al, AFNOR Z9CNAl17-07, GOST 09Ch17Ni7Al, UNI X53CrMnNi21 9



WORKPIECE MATERIAL GROUP (WMG)

ISO group	Subgroup	WMG (Work Material Group)	k_{wc}	Examples of material (AISI, EN, DIN, ČSN, GB, SS, STN, BS, UNE, AFNOR, ASTM, GOST, UNS, UNI, ...)		
K	K1	Gray iron (GG) (iron-carbon castings with a lamellar graphite microstructure)	K1.1	Gray iron, ferritic or ferritic-pearlitic with a hardness of < 180 HB	1.35	ASTM A48 Grade 20 (F11401), EN-JL-100, DIN GG-10 (0.6010), SS 0110, STN 422410, BS Grade 150, UNE FG10, GB HAT 100, AFNOR Fc10D, GOST SC 10, UNI G10
			K1.2	Gray iron, ferritic-pearlitic or pearlitic with a hardness of 180 – 240 HB	1.00	ASTM A48 Grade 30 (F12101), EN-JL-1030, DIN GG-20 (0.6020), SS 0120, STN 422420, BS Grade 220, UNE FG20, GB HT200, AFNOR Fc20D, GOST Ч420, UNI G20
			K1.3	Gray iron, pearlitic with a hardness of 240 – 280 HB	0.75	ASTM A48 Grade 50 (F13501), EN-JL-1060, DIN GG-35 (0.6035), SS 0135, STN 422435, BS Grade 350, UNE FG35, GB HAT300, AFNOR Fc35D, GOST SC35, UNI G35
	K2	Malleable iron (GTS/GTW) (heat-treated iron-carbon castings with a graphite-free microstructure)	K2.1	Malleable iron, ferritic with a hardness of < 160 HB	1.39	ASTM A602 Grade M3210 (F20000), EN-JM-1130, DIN GTS-35 (0.8135), SS 0815, BS B340/12, UNE Type A, AFNOR MN 35-10, GOST K435-10
			K2.2	Malleable iron, ferritic or pearlitic with a hardness of 160 – 200 HB	1.13	ASTM A602 Grade M4504 (F20001), EN-JM-1040, DIN GTS-50-05 (0.8045), BS P50-05, AFNOR MB 45-7
			K2.3	Malleable iron, pearlitic with a hardness of 200 – 240 HB	0.90	ASTM A602 Grade M7002 (F20004), EN-JM-1140, DIN GTS-45 (0.8145), SS 0854, STN 422540, BS P 45-06, UNE Typ B, AFNOR MP 50-5, GOST K445-7, UNI GMM 45
	K3	Ductile iron (GGG) (iron-carbon castings with a nodular graphite microstructure)	K3.1	Ductile (nodular/spheroidal) iron, ferritic with a hardness of < 180 HB	1.23	ASTM A536 Grade 60-40-18 (F32800), EN-JS-1030, DIN GGG-40 (0.7040), SS 0717, STN 422304, BS 420/12, UNE FGE 42-12, GB QT 400, AFNOR FGS 400-12, GOST B440
			K3.2	Ductile (nodular/spheroidal) iron, ferritic or pearlitic with a hardness of 180 – 220 HB	0.94	ASTM A536 Grade 80-55-06 (F33800), EN-JS-1050, DIN GGG-50 (0.7050), SS 0727, STN 422305, BS 500/7, UNE FGE 50-7, GB QT 500-7, AFNOR FGS 500-7, GOST B450
			K3.3	Ductile (nodular/spheroidal) iron, pearlitic with a hardness of 220 – 260 HB	0.76	ASTM A536 Grade 100-70-03 (F34800), EN-JS-1060, DIN GGG-60 (0.7060), SS 0732, STN 422306, BS 600/3, UNE FGT 0-2, GB QT 600-3, AFNOR FGS 600-3, GOST B460
	K4	Austenitic or austempered ductile iron (NI-Resist/ADI) (iron-carbon alloy castings with an austenitic or ausferrite microstructure)	K4.1	Austenitic cast iron with a hardness of < 180 HB	1.14	ASTM A436 Type 1 (L-NiCuCr 15 6 2, F41000), EN-JL-3011, DIN GGL-NiMn 13 7 (0.6652), SS 0523, BS Grade F1, AFNOR FGL-Ni13Mn7, GOST 5-NiMn 13 7
			K4.2	Austenitic cast iron with a hardness of 180 – 240 HB	0.86	ASTM A439 Type D-2B (S-NiCr 20 3, F43001), EN-JS-3021, DIN GGG-NiMn 23 4, SS 0776, BS Grade S2M, AFNOR FGS Ni23 Mn4, GOST ЧH19X3U
			K4.3	Austempered ductile iron with a hardness of 240 – 280 HB	0.63	ASTM A897 Grade 110-70-11
	K5	Compacted graphite iron (CGI) (iron-carbon castings with a vermicular graphite structure)	K4.4	Austempered ductile iron with a hardness of 280 – 320 HB	0.54	ASTM A897 Grade 125-80-10, EN-JS-1100, DIN GGG-90 (5.3400)
			K4.5	Austempered ductile iron with a hardness of 320 – 360 HB	0.45	ASTM A897 Grade 2 (150-110-07), EN-JS-1110, DIN GGG-100 (5.3403)
			K5.1	Vermicular, compacted graphite iron with a hardness of < 180 HB	1.29	ASTM A842 Grade 300, EN-GJV-300, DIN GGV 30, GOST ЧBT30,
K5		K5.2	Vermicular, compacted graphite iron with a hardness of 180 – 220 HB	0.97	ASTM A842 Grade 350, EN-GJV-350, DIN GGV 35 (5.2200), GOST ЧBT30,	
		K5.3	Vermicular, compacted graphite iron with a hardness of 220 – 260 HB	0.75	ASTM A842 Grade 450, EN-GJV-450, DIN GGV 45, GOST ЧBT45,	



WORKPIECE MATERIAL GROUP (WMG)

ISO group	Subgroup	WMG (Work Material Group)	k _{vc}	Examples of material (AISI, EN, DIN, ČSN, GB, SS, STN, BS, UNE, AFNOR, ASTM, GOST, UNS, UNI, ...)
N Non-ferrous metals (metals including alloys without an appreciable amount of iron)	N1 Wrought aluminium	N1.1 Pure aluminium and wrought aluminium alloys with a hardness of < 60 HB	1.33	UNS A91200, EN AL99.6, DIN 3.0205, SS 4010, STN 424009, BS 1C, UNE L-3001, GB L5, AFNOR A4, GOST A1C, UNI 3567
		N1.2 Wrought aluminium alloys with a hardness of 60 – 100 HB	1.00	UNS A93004, EN AlMn0.5Mg0.5, DIN 3.0505, SS 4054, STN 424432, BS N31, UNE L-3831, GB LF2, AFNOR A-M1, GOST AMu, UNI 3568
		N1.3 Wrought aluminium alloys with a hardness of 100 – 150 HB	0.67	UNS A95083, EN AlMg4.5Mn0.7, DIN 3.3547, SS 4140, STN 424415, BS N8, UNE L-3321, GB AlMg4.5Mn, AFNOR A-G4.5Mn, GOST Amg 4.5, UNI P-AlMg4.4
	N2 Cast aluminium	N2.1 Cast aluminium alloys with a hardness of < 75 HB	0.67	UNS A02080, EN AlCu45, BS LM11, STN 424331, UNE AlSi1Cu, GOST AMg5K, UNI G-AlSi7Mg
		N2.2 Cast aluminium alloys with a hardness of 75 – 90 HB	0.60	UNS A02420, EN AlCu4Ni2Mg2, SS AlSi7MgFe, BS LM6, STN 424519, UNE Al-7SiMg, AFNOR A-S7G, GOST AK7, UNI G-AlSi7Mg
		N2.3 Cast aluminium alloys with a hardness of 90 < 140 HB	0.43	UNS A03360, EN G-ALCu4NiMg2, SS AlSi10Mg, STN 424336, BS LM 30, AFNOR A-S10G, UNI G-AlSi9Mg
	N3 Copper or copper alloys	N3.1 Free-cutting copper-alloys materials with excellent machining properties	0.70	UNS C14700, EN CuPb1P, DIN 2.1498, STN 423214, BS C111, AFNOR CuZn35Pb2, GOST L63-3, UNI CuS(P0.01)
		N3.2 Short-chip copper-alloys with good to moderate machining properties	0.41	UNS C81540, EN CuNi25Cr, DIN 2.0857, STN 423220, BS NS113, UNE CuSn12, AFNOR CuZn40, GOST L60, UNI P-CuZn-40
		N3.3 Electrolytic copper and long-chip copper-alloys with moderate to poor machining properties	0.21	UNS C10100, EN CuAg0.1, DIN 2.1203, SS 5010, UNE CuSi3Mn1, AFNOR Cu-C2, GOST M1f, UNI Cu-0F
	N4 Polymers (synthetic or semi-synthetic materials)	N4.1 Thermoplastic polymers	0.70	ABS, Acryl, Duraplast, Elastomer, EP, Epoxid, FEP, Fluor, Gummi, Kautschuk, Latex, ME, MPF, PA, PC, PE, PEEK, PEI, PES, PET, PF, Phenolharze, PI, PMMA, Polyamide, Polyester, Polyolefine, Polysulfon, POM, PP, PPE, PPS, PS, PSU, PTFE, PU, PUR, PVDF, SAN, SI, Styrol, UF, Ureol
		N4.2 Thermosetting polymers	0.27	Aramid, Epoxy, Fluoropolymer, Methacrylate, Melamine, Phenolic, Polyester, Polyimide, Polymethacrylimide, Polyurethane
		N4.3 Reinforced polymers or composites	0.29	CFK, GFK, GMT, Honeycomb, Kevlar, LFT, Organo, SMC
	N5 Graphite	N5.1	1.0	CGM-1, CM-00, GM-10, GM-11, GR030, GR030PI, GR060, GR060PI, GR125, MC-01, MC-01R0, MC-03, MC-03M, IG11, IG-15, IG-32, IG-43, IG-45, IG-70, ISEM-1, ISEM-2, ISEM-3, R8340, R8500X, Technograph 15, Technograph 30, ISO-63, EDM C-3, EDM1, EDM3, ISO-90, ISO-93, ISO-95, R8510, R8650, R8650



WORKPIECE MATERIAL GROUP (WMG)

ISO group	Subgroup	WMG (Work Material Group)	$k_{w,c}$	Examples of material (AISI, EN, DIN, ČSN, GB, SS, STN, BS, UNE, AFNOR, ASTM, GOST, UNS, UNI, ...)
S High-temperature alloys (superalloys with high temperature strength and corrosion resistant surpassing that of stainless steel)	S1 Titanium or titanium alloys	S1.1 Titanium or titanium alloys, with a hardness of <200 HB	1.94	UNS R50250 (Grade 1), EN Ti 99.6, DIN 3.7035, BS TA.2, UNE Ti-Po2, AFNOR T-40, GOST BT1-00, AISI R50250, 3.7025, T35, 2TA1, R50400, 3.7035, 2TAZ,
		S1.2 Titanium alloys, with a hardness of 200 – 280 HB	1.72	UNS R56404 (Grade 29), EN Ti2Cu, DIN 3.7124, BS TA.21, UNE Ti-P11, AFNOR T-U2, AISI TA6V, Ti-6Al-4V, Ti 10.2.3, Ti5553
		S1.3 Titanium alloys, a hardness of 280 – 360 HB	1.44	UNS R54250 (Grade 38), EN TiAl6V4, DIN 3.7165, ČSN TiAl6VELI, BS TA. 13, UNE Ti-P63, AFNOR T-A6V, GOST BT6, AISI TA6V, Ti-6Al-4V, Ti 10.2.3, Ti5553
	S2 Fe-based high-temperature alloys	S2.1 High-temperature Fe-based alloys with a hardness of <200 HB	1.33	UNS N08801 (Incoloy 801), EN X8 NiCrAlTi31-21, DIN 1.4959, BS NA 15, AFNOR Z8NC33-21, AISI A-286, Discaloy, Haynes 556, Inconel 909, Greek Ascology
		S2.2 High-temperature Fe-based alloys with a hardness of 200 – 280 HB	1.17	UNS N19907, EN X6NiCrTiMoVB25-15-2, DIN 1.4980, SS 2570, BS HR52, AFNOR Z6NCTDV25.15B, GOST 36HXT10, AISI A-286, Discaloy, Haynes 556, Inconel 909, Greek Ascology
	S3 Ni-based high-temperature alloys	S3.1 High-temperature Ni-based alloys with a hardness of <280 HB	1.00	UNS A09706 (Inconel 706), EN NiCr25FeAl, DIN 2.4856, BS HR 6, ČSN Inconel 625, UNE F.3313, GB 1Cr16Ni35, AFNOR NC22FeDNB, GOST XH38BT, AISI Inconel 718, 706 Waspalloy, Udimet 720, Inconel 625
		S3.2 High-temperature Ni-based alloys with a hardness of 280 – 360 HB	0.83	UNS N07001, EN NiCr20Co13Mo4Ti3Al, DIN 2.4654, BS HR 2, ČSN Waspalloy, AFNOR NCKD 20ATV, GOST XH80T5K0, AISI Inconel 718, 706 Waspalloy, Udimet 720, Inconel 625
	S4 Co-based high-temperature alloys	S4.1 High-temperature Co-based alloys with a hardness of <240 HB	0.78	UNS R30016 (Stellite 6b), EN CoCr20W15Ni, DIN 2.4964, AFNOR KC 20 WN, GOST ЛК52, AISI Haynes 25, Stellite 21, 31
		S4.2 High-temperature Co-based alloys with a hardness of 240 – 320 HB	0.67	UNS R30016 (Stellite 6b), EN CoCr20W15Ni, DIN 2.4964, AFNOR KC 20 WN, GOST ЛК52, AISI Haynes 25, Stellite 21, 31



WORKPIECE MATERIAL GROUP (WMG)

ISO group	Subgroup	WMG (Work Material Group)	k_{vg}	Examples of material (AISI, EN, DIN, ČSN, GB, SS, STN, BS, UNE, AFNOR, ASTM, GOST, UNS, UNI, ...)
H Hardened materials (any engineering metal with a hardness > 45 HRC)	H1 Chilled cast iron	H1.1 Chilled cast iron with a hardness of < 440 HB	1.52	UNS F45001, EN-GJS-1050-6, DIN 5.3406, SS 0512, BS Grade 2A
		H2.1 Hardened cast iron with a hardness < 55 HRC	0.90	UNS F45003, EN-GJS-1400-1, DIN 5.3405, SS 0457, BS Grade 3D
	H2 Hardened cast iron	H2.2 Hardened cast iron with a hardness > 55 HRC	0.77	UNS F45003, EN G-X260NiCr4-2, DIN 0.9620, SS 0466, BS Grade S
		H3.1 Hardened steel with a hardness of < 51 HRC	1.00	AISI 4135, EN 34CrMo4, DIN 1.7220, SS 2234, STN 415131, BS 198, UNE F.1250, GB 35CrMo, AFNOR 35CD4, GOST AC38XTM, UNI 35CrMo4KB
	H3 Hardened steel < 55 HRC	H3.2 Hardened steel with a hardness of 51 – 55 HRC	0.82	AISI 4135, EN 34CrMo4, DIN 1.7220, SS 2234, STN 415131, BS 198, UNE F.1250, GB 35CrMo, AFNOR 35CD4, GOST AC38XTM, UNI 35CrMo4KB
		H4 Hardened steel > 55 HRC	H4.1 Hardened steel with a hardness of 55 – 59 HRC	0.64
	H4.2 Hardened steel with a hardness of > 59 HRC		0.54	UNS T31501, EN 100MnCrW4, DIN 1.2510, SS 2140, STN 419413, BS B01, UNE F.5220, GB 9CrWMn, AFNOR 90MnWCrV5, GOST 9XBТ, UNI 95MnWCr5KU

GEOMETRY OF CUTTING INSERTS

45



0,15

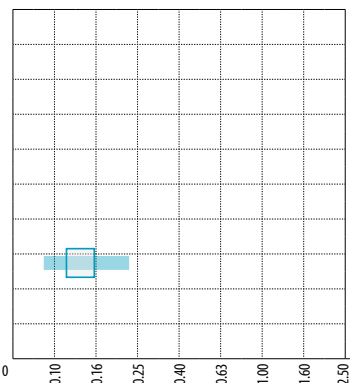

0 0,10 0,16 0,25 0,40 0,63 1,00 1,60 2,50

P **M** **K** **N** **S** **H**

See diagram

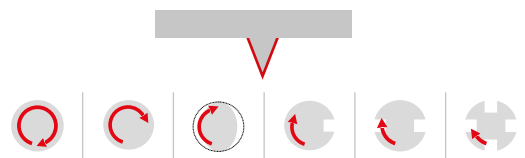

? **WCMT 06, WCMX 06**

46



0,1 R1

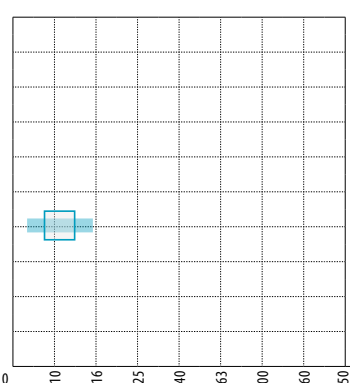

0 0,10 0,16 0,25 0,40 0,63 1,00 1,60 2,50

P **M** **K** **N** **S** **H**

See diagram

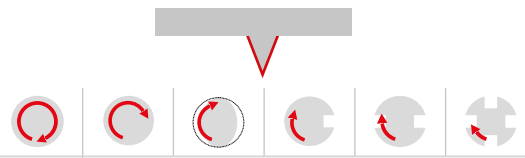

? **WCMT 04, WCMX 03, WCMX 04**

47

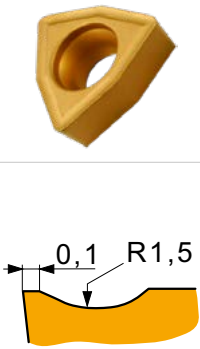

0,1 R1,5

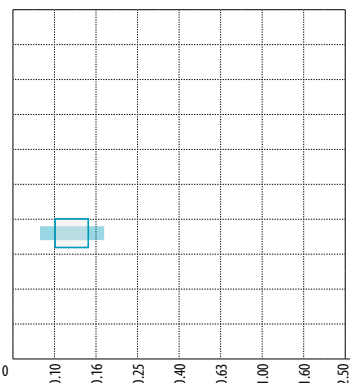

0 0,10 0,16 0,25 0,40 0,63 1,00 1,60 2,50

P **M** **K** **N** **S** **H**

See diagram

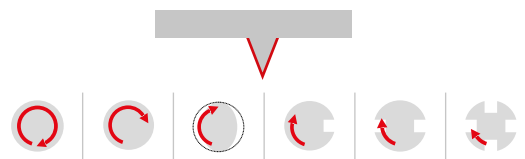

? **WCMT 05, WCMX 05**

48



0,1 R2,5

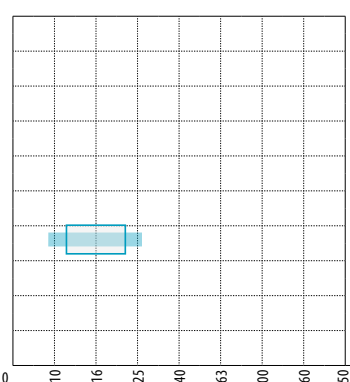

0 0,10 0,16 0,25 0,40 0,63 1,00 1,60 2,50

P **M** **K** **N** **S** **H**

See diagram

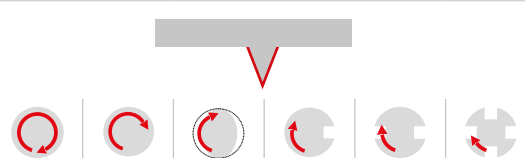

? **WCMT 08, WCMX 08**

GEOMETRY OF CUTTING INSERTS

UM



0,08-0,1
5° 17,5°

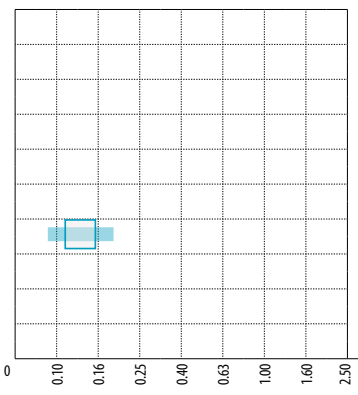

0 0.10 0.16 0.25 0.40 0.63 1.00 1.60 2.50

P	M	K	N	S	H
■	▣	■	■	■	■

f → See diagram

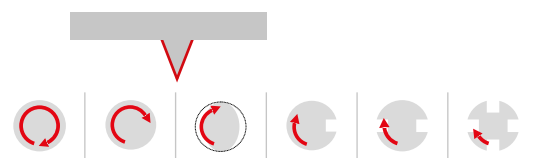

WCMT 04, WCMT 05

SCET.....-UD

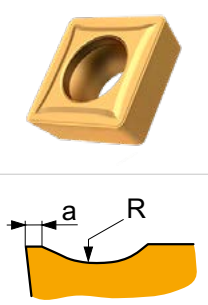

a R

	a
SCET 050204-UD	0,12
SCET 060204-UD	0,15
SCET 070308-UD	0,15
SCET 09T308-UD	0,15
SCET 120408-UD	0,20
SCET 150512-UD	0,20

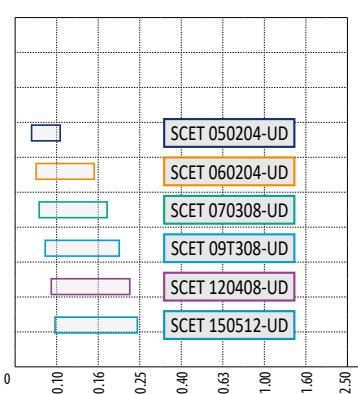

0 0.10 0.16 0.25 0.40 0.63 1.00 1.60 2.50

P	M	K	N	S	H
■	■	■	■	■	■

f → See diagram

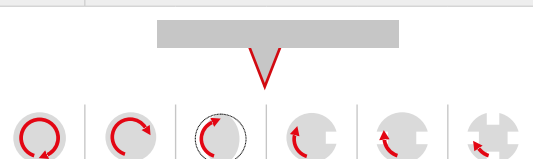

SCET.....-UD

XPET.....AP

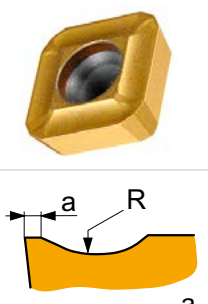

a R

	a
XPET 0502AP	0,10
XPET 0602AP	0,10
XPET 0703AP	0,15
XPET 0903AP	0,25
XPET 11T3AP	0,25
XPET 12T3AP	0,25
XPET 1504AP	0,25
XPET 1904AP	0,25

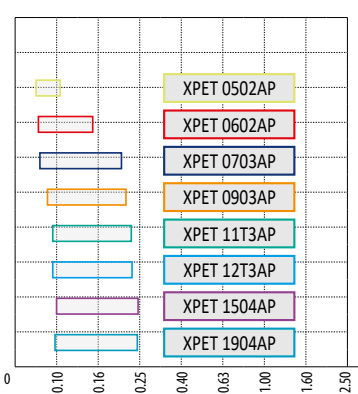

0 0.10 0.16 0.25 0.40 0.63 1.00 1.60 2.50

P	M	K	N	S	H
■	■	■	■	■	■

f → See diagram

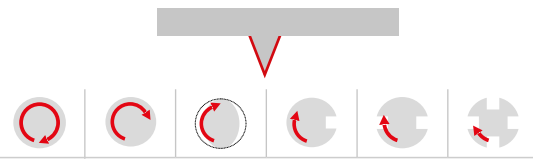

XPET.....AP

GEOMETRY OF CUTTING INSERTS

SCET-SD

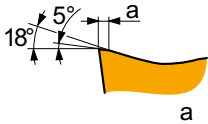

SCET 050204-SD	0,04
SCET 060204-SD	0,06
SCET 070308-SD	0,08
SCET 09T308-SD	0,10
SCET 120408-SD	0,10
SCET 150512-SD	0,10

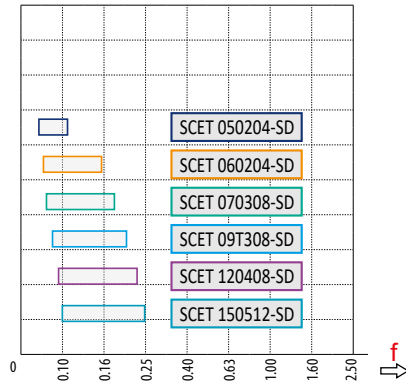

P	M	K	N	S	H
■	■	▣	■	▣	■
f → See diagram					
SCET-SD					

XPETAP-SD

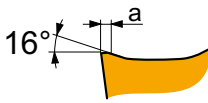



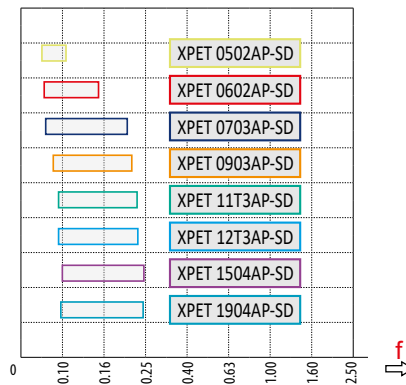

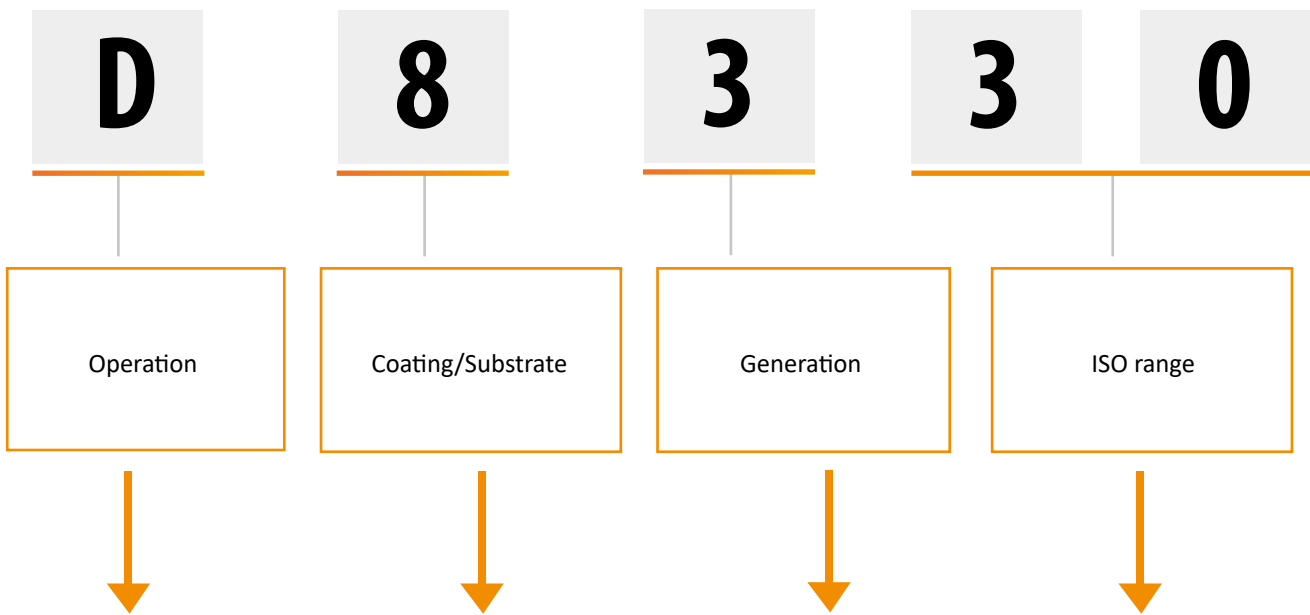

XPET 0502AP-SD	0,04
XPET 0602AP-SD	0,05
XPET 0703AP-SD	0,08
XPET 0903AP-SD	0,10
XPET 11T3AP-SD	0,10
XPET 12T3AP-SD	0,10
XPET 1504AP-SD	0,10
XPET 1904AP-SD	0,12



P	M	K	N	S	H
■	■	▣	■	▣	■
f → See diagram					
XPETAP-SD					



D	Drilling	0 PVD 1 CVD	Special application	1 – 9	01 – 50	
M	Milling	2 PVD 3 CVD	Free			01 – 05
T	Turning	4 PVD 5 CVD	Group K, H			05 – 10
G	Grooving and Parting off	6 PVD 7 CVD	Group M, S			10 – 20
		8 PVD 9 CVD	Universal		20 – 30	
		B	CBN		30 – 40	
		C	Ceramic		40 – 50	
		D	PCD			
		T	Cermet			



DRILLING GRADES

Grade Identification	Area of Application	Application	Feed	Cutting speed	Resistance to adverse Working Conditions	Coating	Colour	Substrate	Coolant benefit	Grade description
D9335	P20 - P35	■				MT-CVD	FGM	FGM	+++	This grade is recommended for the peripheral insert in indexable drills, it is more suited to higher cutting speeds and feeds.
	M15 - M30	■								
	K15 - K35	■								
	S10 - S20	☑								
D8330	P20 - P35	■				PVD	submicron H	submicron H	+++	This is a universal grade for the peripheral insert in indexable drills, it can be used for most materials and stands out for its operational reliability.
	M15 - M30	■								
	K15 - K35	■								
	S10 - S20	☑								
D8345	P30 - P50	■				PVD	submicron H	submicron H	+++	This grade is a universal grade for the central insert in indexable drills, it is an extremely tough suited to most materials.
	M20 - M40	■								
	K30 - K40	■								
	S20 - S30	☑								

Substrate

submicron H	WC-Co based substrate fine grained (< 1 µm)
FGM	Functionally graded substrate

Coating

MT-CVD	Medium-temperature chemical method of coating
PVD	Low-temperature physical method of coating

Benefits of cutting fluid

+++	Use of coolant is essential
-----	-----------------------------



INDEXABLE DRILLS – RECOMMENDED CUTTING CONDITIONS

802D, 803D (XPET..AP, SCET..-UD)



	D9335	D8330	D8345	ø 15	ø 20	ø 25	ø 30	ø 40	ø 58
P1	■	■	■	0.07	0.08	0.09	0.10	0.12	0.16
P2	■	■	■	0.11	0.13	0.15	0.17	0.21	0.28
P3	■	■	■	0.13	0.15	0.18	0.20	0.24	0.32
P4	■	■	■	0.12	0.14	0.16	0.18	0.22	0.30
K1	■	■	■	0.14	0.16	0.19	0.21	0.26	0.34
K2	■	■	■	0.14	0.16	0.19	0.21	0.26	0.34
K3	■	■	■	0.14	0.16	0.19	0.21	0.26	0.34
K4	■	■	■	0.14	0.16	0.19	0.21	0.26	0.34
K5	■	■	■	0.14	0.16	0.19	0.21	0.26	0.34

802D, 803D (XPET..AP-SD, SCET..-SD)



	D9335	D8330	D8345	ø 15	ø 20	ø 25	ø 30	ø 40	ø 58
P1	■	■	■	0.08	0.09	0.10	0.11	0.14	0.18
P2	■	■	■	0.11	0.13	0.15	0.17	0.21	0.28
P3	■	■	■	0.13	0.15	0.18	0.20	0.24	0.32
P4	■	■	■	–	–	–	–	–	–
K1	▣	▣	▣	0.08	0.09	0.10	0.11	0.14	0.18
K2	▣	▣	▣	0.11	0.13	0.15	0.17	0.21	0.28
K3	▣	▣	▣	0.12	0.14	0.16	0.18	0.22	0.24
K4	▣	▣	▣	0.13	0.15	0.18	0.20	0.24	0.32
K5	▣	▣	▣	0.14	0.16	0.19	0.21	0.25	0.33
M1	■	■	■	0.12	0.14	0.16	0.18	0.22	0.30
M2	■	■	■	0.11	0.13	0.15	0.17	0.21	0.28
M3	■	■	■	0.07	0.08	0.09	0.10	0.12	0.16
M4	■	■	■	0.07	0.08	0.09	0.10	0.12	0.16
S1	▣	▣	▣	0.08	0.09	0.10	0.11	0.14	0.18
S2	▣	▣	▣	0.08	0.09	0.10	0.11	0.14	0.18
S3	▣	▣	▣	0.07	0.08	0.09	0.10	0.12	0.16
S4	▣	▣	▣	0.07	0.08	0.09	0.10	0.12	0.16

804D (XPET..AP, SCET..-UD)



	D9335	D8330	D8345	ø 15	ø 20	ø 25	ø 30	ø 40	ø 58
P1	■	■	■	0.06	0.07	0.08	0.09	0.10	0.14
P2	■	■	■	0.10	0.12	0.14	0.16	0.19	0.25
P3	■	■	■	0.12	0.14	0.16	0.18	0.22	0.30
P4	■	■	■	0.11	0.13	0.15	0.17	0.21	0.28
K1	■	■	■	0.13	0.15	0.18	0.20	0.24	0.32
K2	■	■	■	0.13	0.15	0.18	0.20	0.24	0.32
K3	■	■	■	0.13	0.15	0.18	0.20	0.24	0.32
K4	■	■	■	0.13	0.15	0.18	0.20	0.24	0.32
K5	■	■	■	0.13	0.15	0.18	0.20	0.24	0.32



INDEXABLE DRILLS – RECOMMENDED CUTTING CONDITIONS

804D (XPET..AP-SD, SCET..-SD)



	D9335	D8330	D8345	∅ 15	∅ 20	∅ 25	∅ 30	∅ 40	∅ 58
P1	■	■	■	0.07	0.08	0.09	0.10	0.12	0.16
P2	■	■	■	0.10	0.12	0.14	0.16	0.19	0.25
P3	■	■	■	0.12	0.14	0.16	0.18	0.22	0.30
P4	■	■	■	–	–	–	–	–	–
K1	▣	▣	▣	0.07	0.08	0.09	0.10	0.12	0.16
K2	▣	▣	▣	0.10	0.12	0.14	0.16	0.19	0.25
K3	▣	▣	▣	0.11	0.13	0.15	0.17	0.20	0.27
K4	▣	▣	▣	0.12	0.14	0.16	0.18	0.22	0.30
K5	▣	▣	▣	0.14	0.16	0.19	0.21	0.25	0.33
M1	■	■	■	0.11	0.13	0.15	0.17	0.21	0.28
M2	■	■	■	0.10	0.12	0.14	0.16	0.19	0.25
M3	■	■	■	0.06	0.07	0.08	0.09	0.10	0.14
M4	■	■	■	0.06	0.07	0.08	0.09	0.10	0.14
S1	▣	▣	▣	0.07	0.08	0.09	0.10	0.12	0.16
S2	▣	▣	▣	0.07	0.08	0.09	0.10	0.12	0.16
S3	▣	▣	▣	0.06	0.07	0.08	0.09	0.10	0.14
S4	▣	▣	▣	0.06	0.07	0.08	0.09	0.10	0.14

805D (XPET..AP, SCET..-UD)



	D9335	D8330	D8345	∅ 15	∅ 20	∅ 25	∅ 30	∅ 40	∅ 58
P1	■	■	■	0.06	0.07	0.08	0.09	0.10	0.14
P2	■	■	■	0.10	0.12	0.14	0.16	0.19	0.25
P3	■	■	■	0.12	0.14	0.16	0.18	0.22	0.30
P4	■	■	■	0.11	0.13	0.15	0.17	0.21	0.28
K1	■	■	■	0.13	0.15	0.18	0.20	0.24	0.32
K2	■	■	■	0.13	0.15	0.18	0.20	0.24	0.32
K3	■	■	■	0.13	0.15	0.18	0.20	0.24	0.32
K4	■	■	■	0.13	0.15	0.18	0.20	0.24	0.32
K5	■	■	■	0.13	0.15	0.18	0.20	0.24	0.32

805D (XPET..AP-SD, SCET..-SD)



	D9335	D8330	D8345	∅ 15	∅ 20	∅ 25	∅ 30	∅ 40	∅ 58
P1	■	■	■	0.07	0.08	0.09	0.10	0.12	0.16
P2	■	■	■	0.10	0.12	0.14	0.16	0.19	0.25
P3	■	■	■	0.12	0.14	0.16	0.18	0.22	0.30
P4	■	■	■	–	–	–	–	–	–
K1	▣	▣	▣	0.07	0.08	0.09	0.10	0.12	0.16
K2	▣	▣	▣	0.10	0.12	0.14	0.16	0.19	0.25
K3	▣	▣	▣	0.11	0.13	0.15	0.17	0.20	0.27
K4	▣	▣	▣	0.12	0.14	0.16	0.18	0.22	0.30
K5	▣	▣	▣	0.12	0.14	0.16	0.18	0.22	0.30
M1	■	■	■	0.11	0.13	0.15	0.17	0.21	0.28
M2	■	■	■	0.10	0.12	0.14	0.16	0.19	0.25
M3	■	■	■	0.06	0.07	0.08	0.09	0.10	0.14
M4	■	■	■	0.06	0.07	0.08	0.09	0.10	0.14
S1	▣	▣	▣	0.07	0.08	0.09	0.10	0.12	0.16
S2	▣	▣	▣	0.07	0.08	0.09	0.10	0.12	0.16
S3	▣	▣	▣	0.06	0.07	0.08	0.09	0.10	0.14
S4	▣	▣	▣	0.06	0.07	0.08	0.09	0.10	0.14



FORMULA FOR CALCULATION OF CUTTING PARAMETERS

Nomenclature and formula

Parameter	Formula	Unit
RPM	$n = \frac{v_c \cdot 1000}{DC \cdot \pi}$	[rev/min]
Cutting speed	$v_c = \frac{\pi \cdot DC \cdot n}{1000}$	[m/min]
Table feed	$v_f = n \cdot f$	[mm/min]
Cross section area of the hole	$A = \frac{\pi \cdot DC^2}{4}$	[mm ²]
Metal removal rate	$Q = \frac{v_f \cdot A}{1000}$	[cm ³ /min]
Machining time	$T_c = \frac{L + h}{v_f}$	[min/pcs]

DC Diameter of drill

[mm]

h Distance from drill point to workpiece before feeding

[mm]







f Feed per revolution

[mm/rev]

L Depth of hole

[mm]

RECOMMENDED TIGHTENING TORQUES FOR SCREWS

	 Nm					
US 2245-T07P	0.9	FLAG T07P	M 2.2	5.3	D-T7P	MR-0.8-2.0 vario
US 2205-T07P	0.9	FLAG T07P	M2.2	5.4	D-T7P	MR-0.8-2.0 vario
US 2506-T07P	1.2	FLAG T07P	M 2.5	6	D-T7P	MR-0.8-2.0 vario
US 2507-T08P	1.2	FLAG T08P	M 2.5	7	D-T8P	MR-0.8-2.0 vario
US 3007-T08P	2.0	FLAG T08P	M 3	7	D-T8P	MR-1.0-5.0 vario
US 3007-T09P	2.0	FLAG T09P	M 3	7.4	D-T9P	MR-1.0-5.0 vario
US 3009-T09P	2.0	FLAG T09P	M 3	8.7	D-T9P	MR-1.0-5.0 vario
US 3508-T15P	3.0	FLAG T15P	M 3.5	8.3	D-T15P	MR-1.0-5.0 vario
US 3510-T15P	3.0	FLAG T15P	M 3.5	10.6	D-T15P	MR-1.0-5.0 vario
US 4011-T15P	3.5	FLAG T15P	M 4	10.7	D-T15P	MR-1.0-5.0 vario
US 5012-T15P	5.0	FLAG T15P	M 5	12.2	D-T15P	MR-1.0-5.0 vario



MACHINING DATA FOR INDEXABLE DRILLS

Radial adjustment

Hole diameter adjustment and set-up recommendation

Radial adjustment is possible with indexable drills to achieve a smaller or larger hole diameter than the actual drill.

Radial adjustment values are available in the main drill data tables.

Rotating tool

For drilling holes with accuracy IT10 and higher, adjustable holders are recommended when using 802D, 803D, 804D and 805D drills.

Stationary tool

When mounting the drill make sure the drill centre line and workpiece centre are aligned. To achieve a larger hole diameter displace the drill so that the peripheral insert moves in a + away from the workpiece centre line (see diagram below).

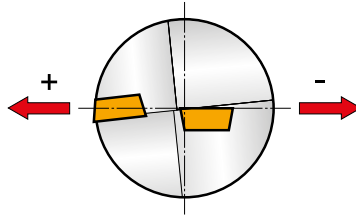

Tool life

Inserts should be changed when flank wear measures 0.2 – 0.4 mm at the largest point.

Cutting data recommendations in this catalogue are aimed at achieving tool life of 7 metres drilling depth on the peripheral insert. (20 – 30 mins contact).

EP

ADJUSTABLE SLEEVE

Shank diameter	Drill diameter	Range
25	15 – 24	0.4 – -0.2
32	24.5 – 40	0.4 – -0.2

For Milling Machines

Diameter adjustment range

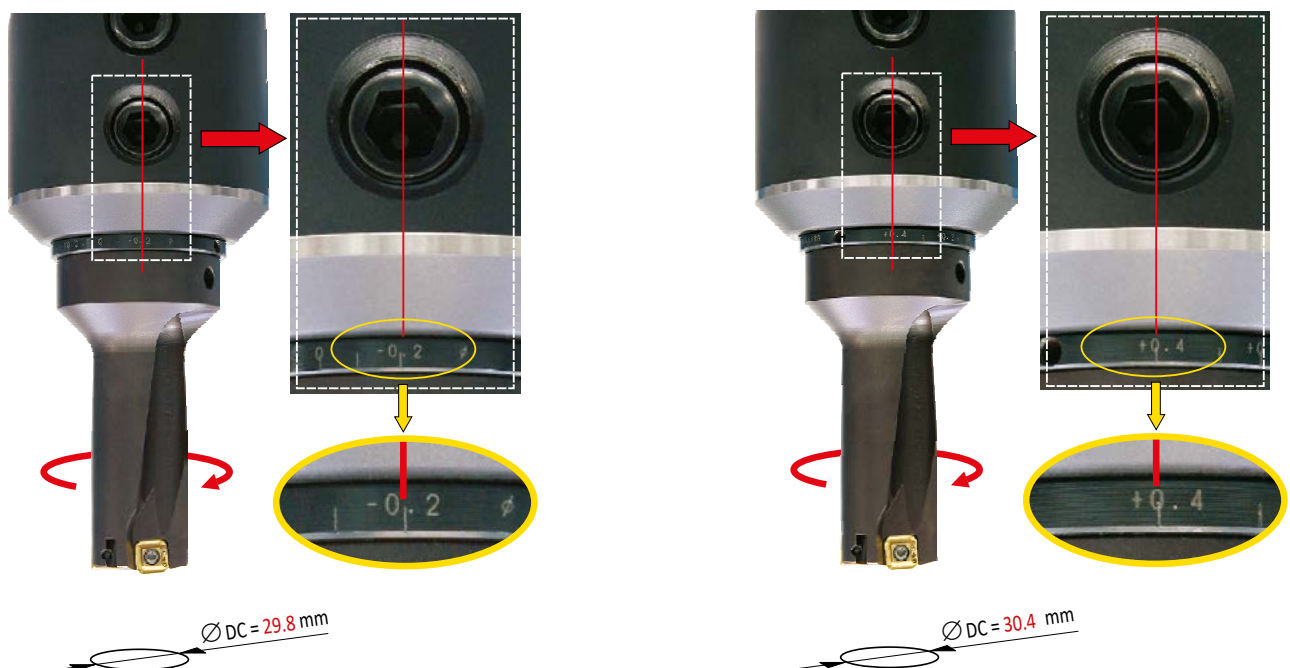



EP

ADJUSTABLE SLEEVE

Shank diameter	Drill diameter	Range
25	15 – 24	0.2 – -0.15
32	24.5 – 40	0.2 – -0.15

Centre height adjustment
– for lathe operation

Centre height adjustment range

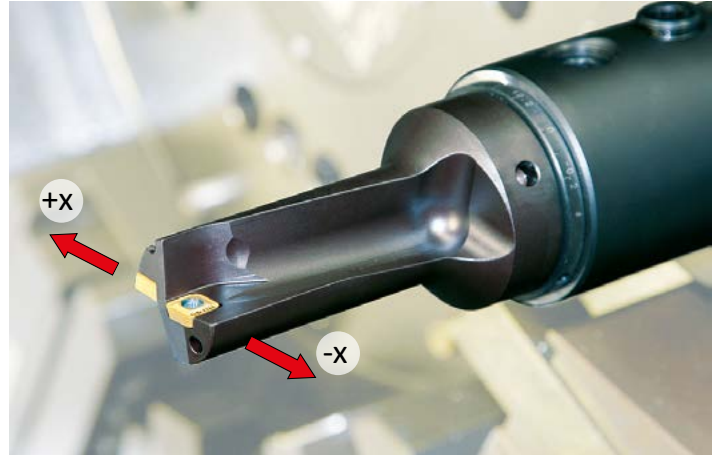

MACHINING DATA FOR INDEXABLE DRILLS

Recommended pressure of supplied cutting fluid

Drill diameter DC [mm]	Pressure of cutting fluid	
	Drill length	
	2.0 – 2.5 DC	3.0 – 5.0 DC
15 – 25	6 bar	12 bar
26 – 40	4.5 bar	9 bar
> 40	3 bar	6 bar

Coolant volume requirement

DRY DRILLING

Pressurised air through the drill is recommended when drilling without coolant in cast iron and steel

Net power consumption

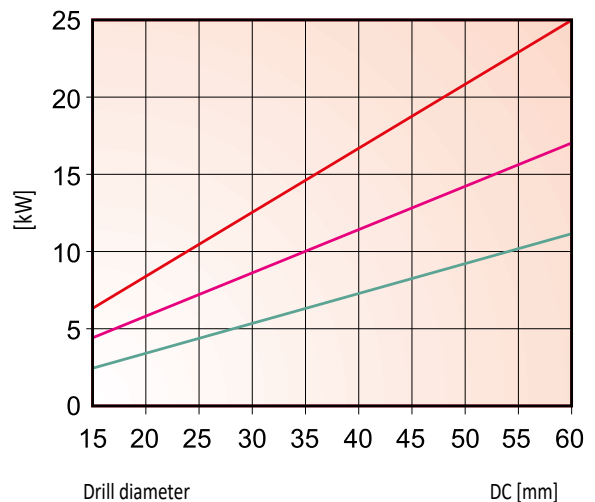
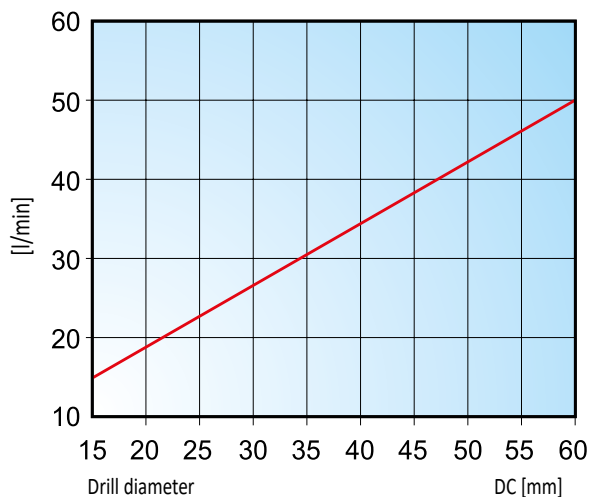

	<p>BLIND HOLE DRILLING For drilling holes deeper than $1 \times DC$ internal cooling is necessary.</p>
	<p>THROUGH HOLE DRILLING A disc can be produced when the indexable drill exits the material. This disc can be ejected at high speed when the workpiece is rotating. It is essential that the machine is adequately guarded to ensure operator safety</p>
	<p>OFF-CENTRE DRILLING Decrease the feed to lower recommended values for particular inserts. See inserts description pages for indexable drills. Do not exceed radial adjustment values.</p>
	<p>STARTING ON UNEVEN AND CAST SURFACES Decrease the feed by 50% on entrance for indexable drills until both inserts are engaged.</p>
	<p>BORING AND DRILLING INTO PILOT HOLES If a pre-drilled hole is larger than $1/4$ drill diameter, decrease the feed.</p>
	<p>DRILLING CROSS HOLES Decrease the feed by 50% when drilling across an existing hole. The diameter of existing hole should not be larger than $0.25 \times DC$.</p>
	<p>INTERRUPTED CUT AND PLUNGING Decrease the feed to lower recommended feed values for particular insert. See inserts description site for indexable drills.</p>
	<p>DRILLING ON CURVED SURFACE Drilling on the centre line can be done with reduced feed rate down to 50 % during entrance and exit.</p>
	<p>DRILLING ON ANGLED SURFACES Decrease the feed by 50% on entrance for indexable drills until both inserts are engaged if the angle of entry is more than 5°.</p>
	<p>EXIT ON ANGLED SURFACE Decrease the feed by 50% on exit if angle of exit is more than 5°.</p>
	<p>STARTING ON A WELDED SEAM Facing is recommended before drilling. Decrease the feed by 50 % during drilling of the welded material.</p>
	<p>DRILLING OF STACKED MATERIALS Avoid spaces larger than 0.2 mm between layers. The component must be securely fixed. If necessary reduce the feed.</p>



TROUBLESHOOTING FOR INDEXABLE DRILLS

LOW PERFORMANCE OF DRIVING MOTOR (LOW SPINDLE POWER)	<ul style="list-style-type: none">a) reduce cutting speed = reduction of spindle RPMb) reduce feed rate
EXCESSIVE WEAR OF PERIPHERAL INSERT	<ul style="list-style-type: none">a) reduce cutting speed = reduction of spindle RPMb) choose a more wear resistant gradec) increase coolant volume and pressure
CHIPPING OF PERIPHERAL INSERT	<ul style="list-style-type: none">a) reduce feed rate until peripheral insert is fully engagedb) choose a tougher insert gradec) reduce cutting speed
CHIPPING OF CENTRE INSERT	<ul style="list-style-type: none">a) reduce feed rate during entryb) check the drill and workpiece clamping
CONTINUOUS, BADLY FORMED CHIP	<ul style="list-style-type: none">a) adjust feed rateb) increase cutting speed and simultaneously reduce feed rate
SWARF CONGESTION IN THE FLUTES	<ul style="list-style-type: none">a) increase coolant volume and pressureb) reduce cutting speedc) adjust feed rate



RECOMMENDED DRILL SIZES FOR TAPPING

Metric ISO threads		Recommended drill diameter for	
Thread	Pitch	Cutting tap	Fluteless tap
M16 × 1.0	1.00	15.0	15.5
M16 × 0.75	0.75	15.3	–
M17 × 1.0	1.00	16.0	–
M18	2.50	15.5	16.8
M18 × 2.0	2.00	16.0	–
M18 × 1.5	1.50	16.5	17.3
M18 × 1.0	1.00	17.0	–
M20	2.50	17.5	18.8
M20 × 2.0	2.00	18.0	–
M20 × 1.5	1.50	18.5	19.3
M20 × 1.0	1.00	19.0	–
M22	2.50	19.5	20.8
M22 × 2.0	2.00	20.0	–
M22 × 1.5	1.50	20.5	21.3
M22 × 1.0	1.00	21.0	–
M24	3.00	21.0	22.5
M24 × 2.0	2.00	22.0	–
M24 × 1.5	1.50	22.5	23.3
M27	3.00	24.0	–
M27 × 2.0	2.00	25.0	–
M30	3.50	26.5	–
M30 × 2.0	2.00	28.0	–
M33	3.50	29.5	–
M36	4.00	32.0	–
M36 × 3.0	3.00	33.0	–
M39	4.00	35.0	–
M42	4.50	37.5	–
M42 × 3.0	3.00	39.0	–
M45	4.50	40.5	–
M48	5.00	43.0	–
M48 × 3.0	3.00	45.0	–
M52	5.00	47.0	–
M52 × 3.0	3.00	48.0	–

Inch threads UNC		Recommended drill diameter for	
Thread	Pitch	Cutting tap	Fluteless tap
3/4"	10	16.7	17.8
7/8"	9	19.5	20.8
1"	8	22.2	23.8
1 1/8"	7	25.0	–
1 1/4"	7	28.2	–
1 3/8"	6	31.0	–
1 1/2"	6	34.0	–
1 3/4"	5	39.5	–
2"	4 1/2	45.2	–
2 1/4"	4 1/2	51.6	–
2 1/2"	4	57.2	–

Whitworth pipe threads		Recommended drill diameter for	
Thread	Pitch	Cutting tap	Fluteless tap
G 3/8"	19	15.3	16.0
G 1/2"	14	19.0	20.0
G 5/8"	14	21.0	22.0
G 3/4"	14	24.5	25.5
G 7/8"	14	28.3	29.3
G 1"	11	30.8	32.0
G 1 1/8"	11	35.5	–
G 1 1/4"	11	39.5	–
G 1 3/8"	11	41.8	–
G 1 1/2"	11	45.3	–
G 1 3/4"	11	51.0	–
G 2"	11	57.0	–

Inch threads UNF		Recommended drill diameter for	
Thread	Pitch	Cutting tap	Fluteless tap
3/4"	16	17.5	18.3
7/8"	14	20.5	21.3
1"	12	23.4	24.3
1 1/8"	12	26.5	–
1 1/4"	12	29.8	–
1 3/8"	12	33.0	–
1 1/2"	12	36.0	–



BORING SYSTEMS





HOLEMAKING – GENERAL CONTENT

6		WMG & ISO 13399
12	DRILLS	INSTRUCTIONS
15		SOLID CARBIDE DRILLS
66		HSS DRILLS
176		CUTTING FLUIDS
186		TECHNICAL INFORMATION
190		REAMERS AND COUNTERSINKS
264	INDEXABLE DRILLS	INSTRUCTIONS
271		HYDRA DRILLS
297		TECHNICAL INFORMATION
307		INDEXABLE DRILLS
327		TECHNICAL INFORMATION
350	BORING SYSTEMS	INSTRUCTIONS
359		BORING HEADS
376		BORING ACCESSORIES
381		INSERTS
404		ARBORS
418		BORING KITS
429		TECHNICAL INFORMATION



1 CCGT

	IC (mm)	D1 (mm)	L (mm)	S (mm)
0602	6.350	2.80	6.40	2.38
0602-SF3	6.350	2.80	6.40	2.58
0803-AL	7.940	3.40	8.10	3.43
0803-SF3	7.940	3.40	8.10	3.43
09T3	9.525	4.40	9.70	3.97
09T3-SF3	9.525	4.40	9.70	4.22
1204	12.700	5.50	12.90	4.76
1204-SF3	12.700	5.50	12.90	5.01

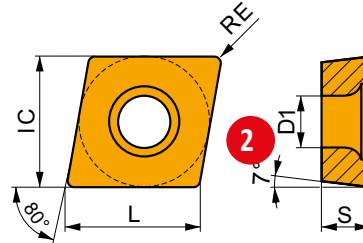

Suitability and starting values for cutting speed (vc), feed (f) and depth of cut (ap). Refer to our Machining Calculator app for further calculations.

Product	RE (mm)	P			M			K			N			S			H		
		vc [m/min]	f [mm/rev]	ap [mm]	vc [m/min]	f [mm/rev]	ap [mm]	vc [m/min]	f [mm/rev]	ap [mm]	vc [m/min]	f [mm/rev]	ap [mm]	vc [m/min]	f [mm/rev]	ap [mm]			

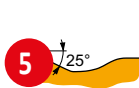

AL geometry with highly positive design for fine-fin **10** rough machining, continuous to slightly interrupted cuts.

CCGT 060202F-AL	HF7	0.2	-	-	-	-	-	-	-	360	0.12	1.0	-	-	-	-	-	-
CCGT 060204F-AL	T0315	0.4	-	-	-	-	-	-	-	300	0.24	1.0	-	-	-	-	-	-
CCGT 080302F-AL	T0315	0.2	-	-	-	-	-	-	-	360	0.12	1.0	-	-	-	-	-	-
CCGT 080304F-AL	HF7	0.4	-	-	-	-	-	-	-	300	0.24	1.0	-	-	-	-	-	-
	T0315	0.4	-	-	-	-	-	-	-	300	0.24	1.0	-	-	-	-	-	-
CCGT 09T302F-AL	HF7	0.2	-	-	-	-	-	-	-	360	0.12	1.0	-	-	-	-	-	-
	T0315	0.2	-	-	-	-	-	-	-	360	0.12	1.0	-	-	-	-	-	-
CCGT 09T304F-AL	HF7	0.4	-	-	-	-	-	-	-	300	0.24	1.5	-	-	-	-	-	-
	T0315	0.4	-	-	-	-	-	-	-	300	0.24	1.5	-	-	-	-	-	-
CCGT 09T308F-AL	HF7	0.8	-	-	-	-	-	-	-	200	0.48	1.5	-	-	-	-	-	-
	T0315	0.8	-	-	-	-	-	-	-	200	0.48	1.5	-	-	-	-	-	-
CCGT 120404F-AL	HF7	0.4	-	-	-	-	-	-	-	300	0.24	2.4	-	-	-	-	-	-
	T0315	0.4	-	-	-	-	-	-	-	300	0.24	2.4	-	-	-	-	-	-
CCGT 120408F-AL	HF7	0.8	-	-	-	-	-	-	-	200	0.48	2.4	-	-	-	-	-	-
	T0315	0.8	-	-	-	-	-	-	-	200	0.48	2.4	-	-	-	-	-	-

CCGT120404F-AL:T0315

Use full insert specification code when ordering!

Grade

Include colon

ISO insert code



INSERTS – PAGE OVERVIEW

Pos.	Description	Pos.	Description
1	Designation of insert	7	ISO insert code
2	Schematic drawing of insert	8	Grade
3	Table with insert sizes [mm]	9	Insert radii [mm]
4	Picture of representative insert	10	Geometry description
5	Profile of main cutting edge	11	Application area of insert
6	Icons – specific features and cutting edge type		

1 D75-BB

P M K N S H 2

PRAMET 3 **S(P)**



75° Roughing Boring Head, Large Bore - Ø220 up to Ø500 mm

High performance 75° small boring head for roughing. Suited for through, blind and cross hole boring and chamfering. Available to utilise CC., TC. or CN. type inserts and for hole diameter range Ø220 up to 500 mm with arbor sizes from 300 up to 500 mm. High accuracy and repeatability.

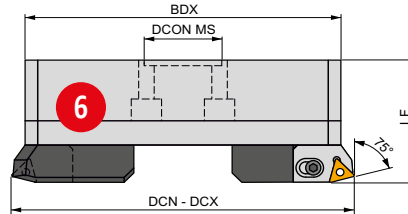

Product	CZC MS	DCN	DCX	BDX	DCON MS	LF	Inserts	Arbors	Chamfers	Drill Bits	Reamers	Chamfers	Weight		
	(mm)	(mm)	(mm)	(mm)	(mm)	(mm)							(kg)		
D 30075 300	300	220.00	320.00	202	60.00	90.00	3CT 75 300	US 0625	HXK 5	TC.. 16T3..	US 0415-T15P	SDR T15P	HXK 5	HXK 4	9.40
D 30075 402	300	220.00	320.00	202	60.00	90.00	3CT 75 402	US 0625	HXK 5	CC.. 1204..	US 0513-T20P	SDR T20P	HXK 5	HXK 4	9.37
D 30075 402N	300	220.00	320.00	202	60.00	90.00	3CT 75 402 N	US 0625	HXK 5	CN.. 1204..	US 0613-H25	HXK 2.5	HXK 5	HXK 4	9.37
D 40075 300	400	290.00	400.00	272	60.00	90.00	3CT 75 300	US 0625	HXK 5	TC.. 16T3..	US 0415-T15P	SDR T15P	HXK 5	HXK 4	17.08
D 40075 402	400	290.00	400.00	272	60.00	90.00	3CT 75 402	US 0625	HXK 5	CC.. 1204..	US 0513-T20P	SDR T20P	HXK 5	HXK 4	17.08
D 40075 402N	400	290.00	400.00	272	60.00	90.00	3CT 75 402 N	US 0625	HXK 5	CN.. 1204..	US 0613-H25	HXK 2.5	HXK 5	HXK 4	17.08

1 69871-BS

PRAMET



DIN 69871 Shank Tool Holder for Boring Heads

DIN 69871 highly rigid tool holder (for ATC) for boring heads, available in 30, 40 and 50 tapers. Different length arbors available. Coupling sizes 22-160 mm can be used with EXT-BS extenders, RED-BS reducers, LA-BS enlargers. Internal coolant available. For applications requiring high accuracy and repeatability.

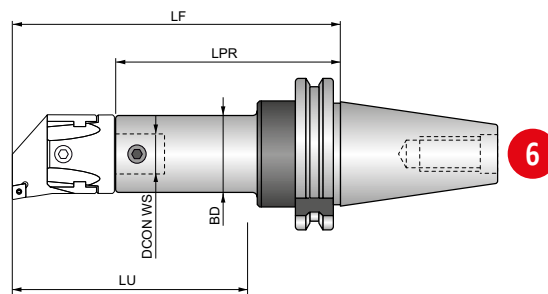

Product	CZC MS	BD	DCON WS	LF	LPR	LU	Inserts	Arbors	Weight
	(mm)	(mm)	(mm)	(mm)	(mm)	(mm)			(kg)
AS 330 022 100 R	30	22	22.00	12.00	138.00	104	✓	US 0608	0.72
AS 330 027 055 R	30	27	27.00	15.00	90.00	48	✓	US 0609	0.56
AS 330 027 100 R	30	27	27.00	15.00	138.00	96	✓	US 0609	0.68
AS 330 060 R	30	32.00	20.00	12	51	60.00	✓	US 0608	0.56
AS 330 100 R	30	32.00	20.00	12	93	100.00	✓	US 0608	0.72
AS 340 022 080 R	40	22	22.00	12.00	118.00	84	✓	US 0608	1.14

Typical page with boring heads and arbors displayed – specific page details will differ.



BORING TOOLS AND ARBORS – PAGE OVERVIEW

Pos.	Designation	Pos.	Designation
1	Designation of boring head/arbor	13	Cartridge
2	Material group recommendations	14	Cartridge screw
3	Clamping system of insert	15	Key for cartridge screw
4	Illustrative picture	16	Group of compatible inserts
5	Tool description	17	Insert screw
6	Schematic drawing of tool	18	Key for insert screw
7	Achievable quality of surface	19	Adjusting key for head
8	Product features	20	Locking key for head
9	Product applications	21	Weight [kg]
10	Tool code ¹⁾	22	Internal supply of coolant
11	Size code of head/arbor ²⁾	23	Clamping screw for head
12	Tool dimensions	24	Arbor size ³⁾

¹⁾ Tool code designation is included in product pages

²⁾ Boring head and arbor have to have the same size code to guarantee compatibility.

³⁾ See schematic drawing for type of arbor.



DORMER PRAMET



EVERY MATERIAL

Machining steel, stainless steel, cast iron, super-alloys or non-ferrous materials, all are covered within our calculator app. Download it from your app store today. **Simply Reliable.**

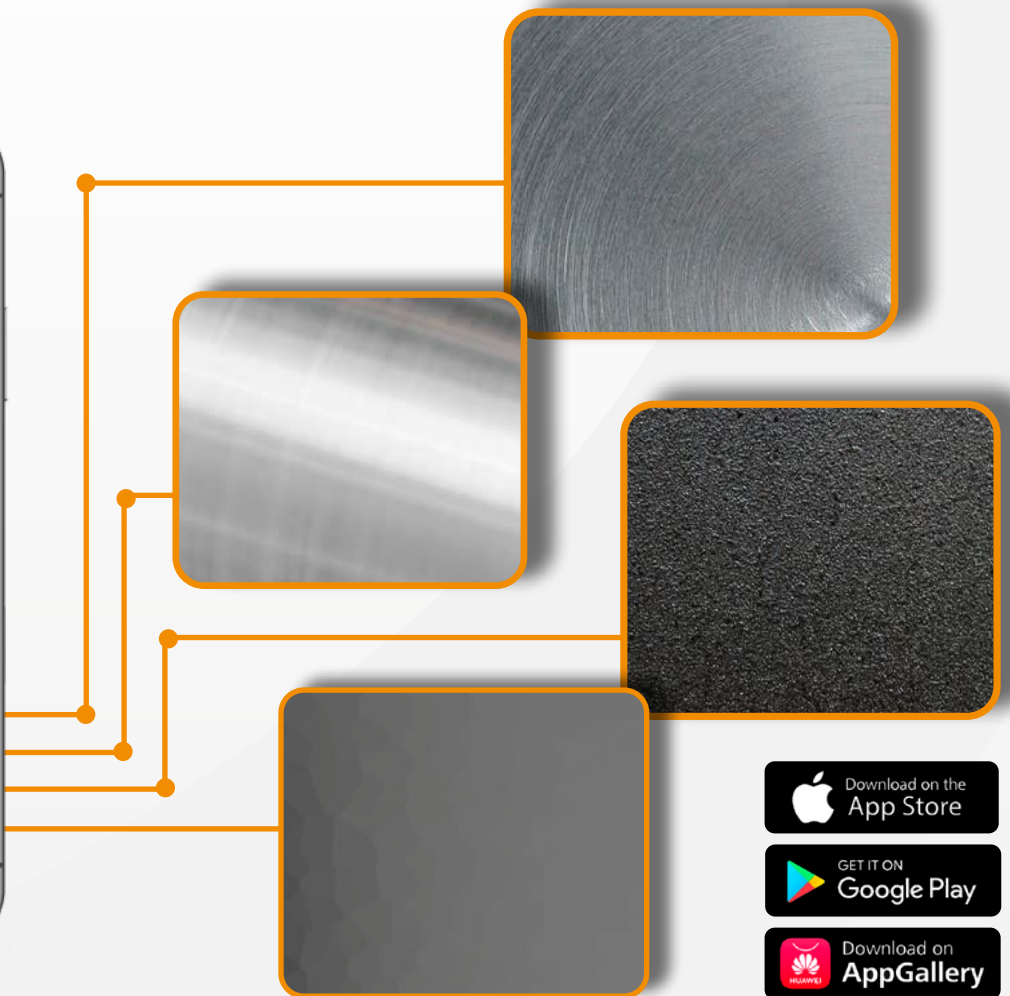



BORING – ICONS OVERVIEW

General Icons

	Primary use		Finishing – very good surface quality		Roughing – unlimited surface roughness
	Possible use		Medium machining – good surface quality		

General Features of Tools

	1 effective tooth per revolution		Adjustable diameter of tool
	2 effective teeth per revolution		

Operations Drilling

	Blind hole boring		Boring up to a shoulder		Chamfering (beveling) in hole
	Boring through cross holes		Chamfering (beveling)		Through hole boring

Features

	First choice		High Speed Cutting		Edge with facet
	For short chipping materials		Large overhang		Rounded edge
	For tough materials (long chipping)		Thin-walled and slim workpieces		Rounded edge with double facet
	Heavy working conditions		Universal wide range option		Rounded edge with facet
					Sharp edge

Other





	Taper size
--	------------

Technical Pages

	Feed [mm/rev]		Medium cutting speed, system rigidity limited (slightly interrupted cut)
	Very high cutting speed, excellent system rigidity (stable working conditions)		Low cutting speed, low system rigidity (interrupted cut)
	High cutting speed, high system rigidity (stable working conditions)		Very low cutting speed, very low system rigidity (very unstable working conditions)
	High cutting speed, system rigidity slightly limited (depth of cut changing)		



BORING SYSTEMS – NAVIGATOR



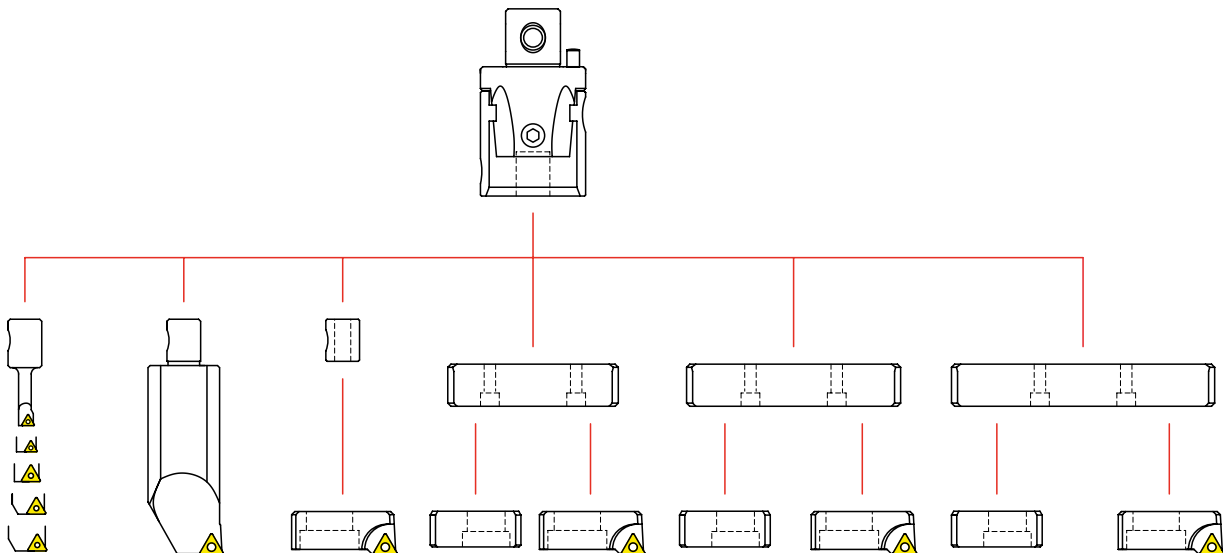

	ROUGHING HEADS		
			
Description	D75 / D90	D75-C/D90-C	D75-BB/D90-BB
Boring diameter	24 – 82	80 – 220	220 – 500
Hole tolerance	IT9	IT9	IT9
Max. Boring depth	5×D	4×D	–
Entry angle	75° / 90°	75° / 90°	75° / 90°
Adjustment precision (mm/Ø)	–	–	–
	361, 364	362, 365	363, 366

BORING KITS – 420 – 427















BORING SYSTEMS – NAVIGATOR

FINISHING HEADS			MICRO BORING HEADS	
				
F75/F90	F75-C/F90-C	F75-BB/F90-BB	MB-H	
24 – 82	80 – 220	220 – 500	8 – 38	
IT7	IT7	IT7	IT6	
5×D	4×D	–	–	
75° / 90°	75° / 90°	75° / 90°	–	
0.002	0.002	0.002	0.002	
367, 370	368, 371	369, 372	373	

BORING BARS

ISO BARS	ISO BARS A042	CHAM-BS	CART-BS	INSERTS
 374	 375	 380	 378	 388
				



BORING SYSTEMS – NAVIGATOR

ARBORS

69871-BS ISO 30, 40, 50	BT-BS ISO 30, 40, 50	HSK-BS 50A, 63A, 100A	2080-BS ISO 40, 50	MOR-BS MORSE	WEL-BS WELDON
406	408	410	411	413	414
					

ACCESSORIES

EXT-BS	RED-BS	LA-BS
415	416	417
		

BORING KITS – 420 – 427





BORING HEADS



BORING HEAD DESCRIPTION

1	2	3	4
D	042	75	402N

1		2	3	4	
Type of tool		Size	Cutting edge angle	Inserts pocket code	
D	Roughing Head	022	75	300	TC..16T3.
		027	90	400	CC..0602..
		032		401	CC..0803..
		042		402	CC..1204..
A	Finishing Head	054		409	CC..09T3..
		068		402N	CN..1204..
		085			
		100			
		200			
		300			
		400			
		500			



D75



PRAMET

S(P)



75° Roughing Boring Head, Small Bore - Ø24 up to Ø82 mm

High performance 75° small boring head for roughing. Suited for through, blind and cross hole boring and chamfering. Available to utilise CC., TC. or CN. type inserts and for hole diameter range Ø24 up to Ø82 mm with arbor sizes from 22 up to 54 mm. High accuracy and repeatability.

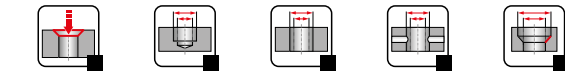
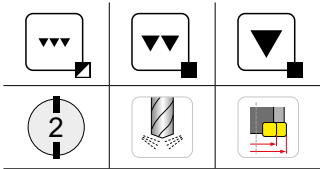
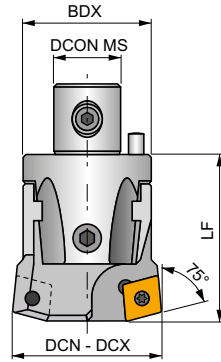

Product	CZC MS	DCN	DCX	BDX	DCON MS	LF						
D 02275 400	22	24.00	30.00	22	12.00	34.00	CC.. 0602..	US 0206-T08P	SDR T08P	HXK 2	HXK 3	0.10
D 02775 401	27	29.00	40.00	27	15.00	42.00	CC.. 0803..	US 0307-T10P	SDR T10P	HXK 2	HXK 4	0.17
D 02775 409	27	29.00	40.00	27	15.00	42.00	CC.. 09T3..	US 0408-T15P	SDR T15P	HXK 2	HXK 4	0.17
D 03275 401	32	39.00	50.00	32	20.00	45.00	CC.. 0803..	US 0307-T10P	SDR T10P	HXK 2.5	HXK 4	0.27
D 03275 409	32	39.00	50.00	32	20.00	45.00	CC.. 09T3..	US 0408-T15P	SDR T15P	HXK 2.5	HXK 4	0.27
D 04275 300	42	49.00	65.00	42	24.00	56.00	TC.. 16T3..	US 0415-T15P	SDR T15P	HXK 3	HXK 5	0.54
D 04275 402	42	49.00	65.00	42	24.00	56.00	CC.. 1204..	US 0513-T20P	SDR T20P	HXK 3	HXK 5	0.54
D 04275 402N	42	53.00	65.00	42	24.00	56.00	CN.. 1204..	US 0613-H25	HXK 2.5	HXK 3	HXK 5	0.53
D 05475 300	54	63.00	82.00	54	28.00	66.00	TC.. 16T3..	US 0415-T15P	SDR T15P	HXK 3	HXK 6	1.07
D 05475 402	54	63.00	82.00	54	28.00	66.00	CC.. 1204..	US 0513-T20P	SDR T20P	HXK 3	HXK 6	1.07
D 05475 402N	54	63.00	82.00	54	28.00	66.00	CN.. 1204..	US 0613-H25	HXK 2.5	HXK 3	HXK 6	1.03



D75-C

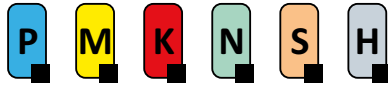

PRAMET

S(P)



75° Roughing Boring Head, Medium Bore - Ø80 up to Ø220 mm

High performance 75° medium boring head for roughing. Suited for through, blind and cross hole boring and chamfering. Available to utilise CC., TC.. or CN.. type inserts and for hole diameter range Ø80 up to Ø220 mm with arbor sizes from 68 up to 200 mm. High accuracy and repeatability.

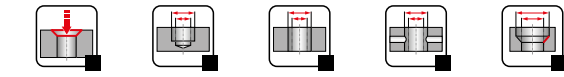
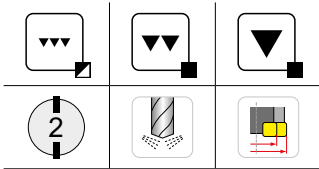
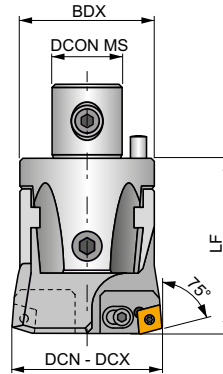

Product	CZC MS	DCN	DCX	BDX	DCON MS	LF									
		[mm]	[mm]	[mm]	[mm]	[mm]									
D 06875 300	68	80.00	102.00	68	36.00	86.00	2CT 75 300	US 0616	HXK 5	TC.. 16T3..	US 0408-T15P	SDR T15P	HXK 4	HXK 8	2.16
D 06875 402	68	80.00	102.00	68	36.00	86.00	2CT 75 402	US 0616	HXK 5	CC.. 1204..	US 0509-T20P	SDR T20P	HXK 4	HXK 8	2.15
D 06875 402N	68	80.00	102.00	68	36.00	86.00	2CT 75 402 N	US 0616	HXK 5	CN.. 1204..	US 0613-H25	HXK 2.5	HXK 4	HXK 8	2.21
D 08575 300	85	100.00	125.00	85	50.00	100.00	3CT 75 300	US 0625	HXK 5	TC.. 16T3..	US 0415-T15P	SDR T15P	HXK 5	HXK 8	4.16
D 08575 402	85	100.00	125.00	85	50.00	100.00	3CT 75 402	US 0625	HXK 5	CC.. 1204..	US 0513-T20P	SDR T20P	HXK 5	HXK 8	4.13
D 08575 402N	85	100.00	125.00	85	50.00	100.00	3CT 75 402 N	US 0625	HXK 5	CN.. 1204..	US 0613-H25	HXK 2.5	HXK 5	HXK 8	4.23
D 10075 300	100	125.00	160.00	110	60.00	100.00	3CT 75 300	US 0625	HXK 5	TC.. 16T3..	US 0415-T15P	SDR T15P	HXK 5	HXK 8	6.57
D 10075 402	100	125.00	160.00	110	60.00	100.00	3CT 75 402	US 0625	HXK 5	CC.. 1204..	US 0513-T20P	SDR T20P	HXK 5	HXK 8	6.55
D 10075 402N	100	125.00	160.00	110	60.00	100.00	3CT 75 402 N	US 0625	HXK 5	CN.. 1204..	US 0613-H25	HXK 2.5	HXK 5	HXK 8	6.57
D 20075 300	200	160.00	220.00	145	60.00	100.00	3CT 75 300	US 0625	HXK 5	TC.. 16T3..	US 0415-T15P	SDR T15P	HXK 5	HXK 8	8.87
D 20075 402	200	160.00	220.00	145	60.00	100.00	3CT 75 402	US 0625	HXK 5	CC.. 1204..	US 0513-T20P	SDR T20P	HXK 5	HXK 8	8.88
D 20075 402N	200	160.00	220.00	145	60.00	100.00	3CT 75 402 N	US 0625	HXK 5	CN.. 1204..	US 0613-H25	HXK 2.5	HXK 5	HXK 8	8.95



D75-BB

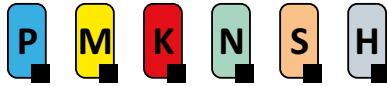

PRAMET

S(P)



75° Roughing Boring Head, Large Bore - Ø220 up to Ø500 mm

High performance 75° large boring head for roughing. Suited for through, blind and cross hole boring and chamfering. Available to utilise CC., TC. or CN. type inserts and for hole diameter range Ø220 up to Ø500 mm with arbor sizes from 300 up to 500 mm. High accuracy and repeatability.

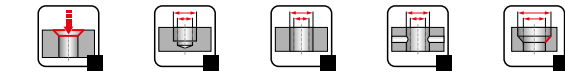
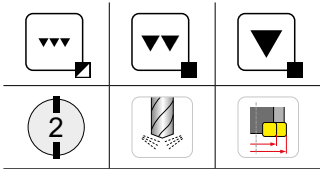
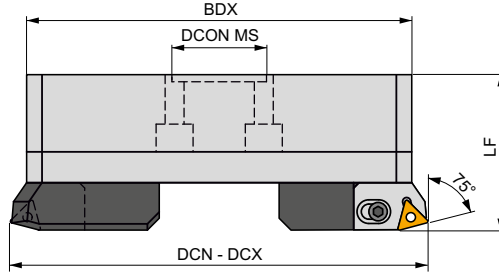

Product	CZC MS	DCN	DCX	BDX	DCON MS	LF									
		[mm]	[mm]	[mm]	[mm]	[mm]									
D 30075 300	300	220.00	320.00	202	60.00	90.00	3CT 75 300	US 0625	HXK 5	TC.. 16T3..	US 0415-T15P	SDRT15P	HXK 5	HXK 4	9.40
D 30075 402	300	220.00	320.00	202	60.00	90.00	3CT 75 402	US 0625	HXK 5	CC.. 1204..	US 0513-T20P	SDRT20P	HXK 5	HXK 4	9.37
D 30075 402N	300	220.00	320.00	202	60.00	90.00	3CT 75 402 N	US 0625	HXK 5	CN.. 1204..	US 0613-H25	HXK 2.5	HXK 5	HXK 4	9.37
D 40075 300	400	290.00	400.00	272	60.00	90.00	3CT 75 300	US 0625	HXK 5	TC.. 16T3..	US 0415-T15P	SDRT15P	HXK 5	HXK 4	12.92
D 40075 402	400	290.00	400.00	272	60.00	90.00	3CT 75 402	US 0625	HXK 5	CC.. 1204..	US 0513-T20P	SDRT20P	HXK 5	HXK 4	12.95
D 40075 402N	400	290.00	400.00	272	60.00	90.00	3CT 75 402 N	US 0625	HXK 5	CN.. 1204..	US 0613-H25	HXK 2.5	HXK 5	HXK 4	12.98
D 50075 300	500	370.00	500.00	352	60.00	90.00	3CT 75 300	US 0625	HXK 5	TC.. 16T3..	US 0415-T15P	SDRT15P	HXK 5	HXK 4	16.74
D 50075 402	500	370.00	500.00	352	60.00	90.00	3CT 75 402	US 0625	HXK 5	CC.. 1204..	US 0513-T20P	SDRT20P	HXK 5	HXK 4	16.74
D 50075 402N	500	370.00	500.00	352	60.00	90.00	3CT 75 402 N	US 0625	HXK 5	CN.. 1204..	US 0613-H25	HXK 2.5	HXK 5	HXK 4	16.74



D90



PRAMET

S(P)



90° Roughing Boring Head, Small Bore - Ø24 up to Ø82 mm

High performance 90° small boring head for roughing. Suited for through, blind hole and cross hole boring. Available to utilise CC., TC., CN.. type inserts and for hole diameter range Ø24 up to Ø82 mm with arbor sizes from 22 up to 54 mm. High accuracy and repeatability.

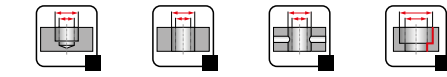
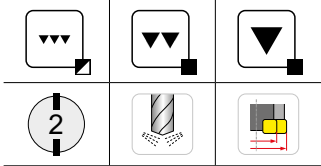
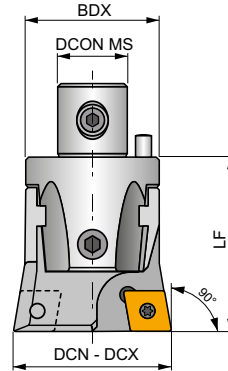

Product	CZC MS	DCN	DCX	BDX	DCON MS	LF						
D 02290 400	22	24.00	30.00	22	12.00	34.00	CC.. 0602..	US 0206-T08P	SDT T08P	HXX 2	HXX 3	0.10
D 02790 401	27	29.00	40.00	27	15.00	42.00	CC.. 0803..	US 0307-T10P	SDR T10P	HXX 2	HXX 4	0.17
D 02790 409	27	29.00	40.00	27	15.00	42.00	CC.. 09T3..	US 0408-T15P	SDR T15P	HXX 2	HXX 4	0.17
D 03290 401	32	39.00	50.00	32	20.00	45.00	CC.. 0803..	US 0307-T10P	SDR T10P	HXX 2.5	HXX 4	0.03
D 03290 409	32	39.00	50.00	32	20.00	45.00	CC.. 09T3..	US 0408-T15P	SDR T15P	HXX 2.5	HXX 4	0.27
D 04290 300	42	49.00	65.00	42	24.00	56.00	TC.. 16T3..	US 0415-T15P	SDR T15P	HXX 3	HXX 5	0.54
D 04290 402	42	49.00	65.00	42	24.00	56.00	CC.. 1204..	US 0513-T20P	SDR T20P	HXX 3	HXX 5	0.54
D 04290 402N	42	53.00	65.00	42	24.00	56.00	CN.. 1204..	US 0613-H25	HXX 2.5	HXX 3	HXX 5	0.53
D 05490 300	54	63.00	82.00	54	28.00	66.00	TC.. 16T3..	US 0415-T15P	SDR T15P	HXX 3	HXX 6	1.06
D 05490 402	54	63.00	82.00	54	28.00	66.00	CC.. 1204..	US 0513-T20P	SDR T20P	HXX 3	HXX 6	1.06
D 05490 402N	54	63.00	82.00	54	28.00	66.00	CN.. 1204..	US 0613-H25	HXX 2.5	HXX 3	HXX 6	1.06



D90-C

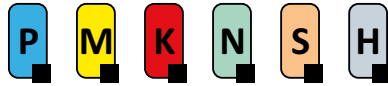

PRAMET

S(P)



90° Roughing Boring Head, Medium Bore - Ø80 up to Ø220 mm

High performance 90° medium boring head for roughing. Suited for through, blind hole and cross hole boring. Available to utilise CC., TC., CN. type inserts and for hole diameter range Ø80 up to Ø220 mm with arbor sizes from 68 up to 200 mm. High accuracy and repeatability.

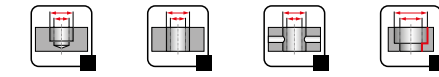
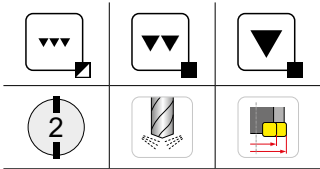
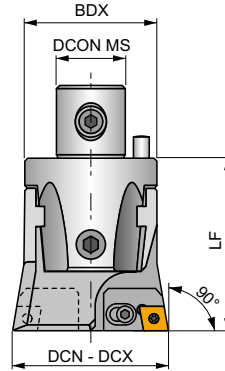

Product	CZC MS	DCN	DCX	BDX	DCON MS	LF									
D 06890 300	68	80.00	102.00	68	36.00	86.00	2CT 90 300	US 0616	HXK 5	TC.. 16T3..	US 0408-T15P	SDR T15P	HXK 4	HXK 8	2.17
D 06890 402	68	80.00	102.00	68	36.00	86.00	2CT 90 402	US 0616	HXK 5	CC.. 1204..	US 0509-T20P	SDR T20P	HXK 4	HXK 8	2.15
D 06890 402N	68	80.00	102.00	68	36.00	86.00	2CT 90 402 N	US 0616	HXK 5	CN.. 1204..	US 0613-H25	HXK 2.5	HXK 4	HXK 8	2.18
D 08590 300	85	100.00	125.00	85	50.00	100.00	3CT 90 300	US 0625	HXK 5	TC.. 16T3..	US 0415-T15P	SDR T15P	HXK 5	HXK 8	4.52
D 08590 402	85	100.00	125.00	85	50.00	100.00	3CT 90 402	US 0625	HXK 5	CC.. 1204..	US 0513-T20P	SDR T20P	HXK 5	HXK 8	4.12
D 08590 402 N	85	100.00	125.00	85	50.00	100.00	3CT 90 402 N	US 0625	HXK 5	CN.. 1204..	US 0613-H25	HXK 2.5	HXK 5	HXK 8	4.17
D 10090 300	100	125.00	160.00	110	60.00	100.00	3CT 90 300	US 0625	HXK 5	TC.. 16T3..	US 0415-T15P	SDR T15P	HXK 5	HXK 8	6.54
D 10090 402	100	125.00	160.00	110	60.00	100.00	3CT 90 402	US 0625	HXK 5	CC.. 1204..	US 0513-T20P	SDR T20P	HXK 5	HXK 8	6.56
D 10090 402 N	100	125.00	160.00	110	60.00	100.00	3CT 90 402 N	US 0625	HXK 5	CN.. 1204..	US 0613-H25	HXK 2.5	HXK 5	HXK 8	6.40
D 20090 300	200	160.00	220.00	145	60.00	100.00	3CT 90 300	US 0625	HXK 5	TC.. 16T3..	US 0415-T15P	SDR T15P	HXK 5	HXK 8	8.90
D 20090 402	200	160.00	220.00	145	60.00	100.00	3CT 90 402	US 0625	HXK 5	CC.. 1204..	US 0513-T20P	SDR T20P	HXK 5	HXK 8	8.89
D 20090 402 N	200	160.00	220.00	145	60.00	100.00	3CT 90 402 N	US 0625	HXK 5	CN.. 1204..	US 0613-H25	HXK 2.5	HXK 5	HXK 8	8.91



D90-BB

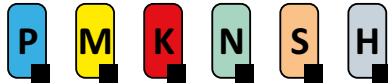

PRAMET

S(P)



90° Roughing Boring Head, Large Bore - Ø220 up to Ø500 mm

High performance 90° large boring head for roughing. Suited for through, blind hole and cross hole boring. Available to utilise CC., TC., CN. type inserts and for hole diameter range Ø80 up to Ø220 mm with arbor sizes from 68 up to 200 mm. High accuracy and repeatability.

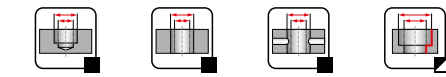
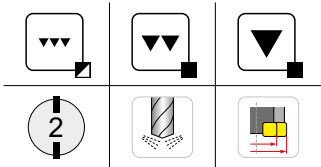
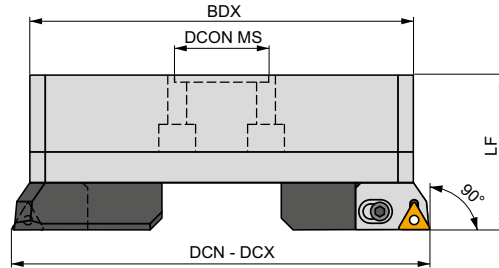

Product	CZC MS	DCN	DCX	BDX	DCON MS	LF										
		[mm]	[mm]	[mm]	[mm]	[mm]										
D 30090 300	300	220.00	320.00	202	60.00	90.00	3CT 90 300	US 0625	HXK 5	TC.. 16T3..	US 0415-T15P	SDRT15P	HXK 5	HXK 4	9.45	
D 30090 402	300	220.00	320.00	202	60.00	90.00	3CT 90 402	US 0625	HXK 5	CC.. 1204..	US 0513-T20P	SDRT20P	HXK 5	HXK 4	9.47	
D 30090 402 N	300	220.00	320.00	202	60.00	90.00	3CT 90 402 N	US 0625	HXK 5	CN.. 1204..	US 0613-H25	HXK 2.5	HXK 5	HXK 4	9.56	
D 40090 300	400	290.00	400.00	272	60.00	90.00	3CT 90 300	US 0625	HXK 5	TC.. 16T3..	US 0415-T15P	SDRT15P	HXK 5	HXK 4	12.98	
D 40090 402	400	290.00	400.00	272	60.00	90.00	3CT 90 402	US 0625	HXK 5	CC.. 1204..	US 0513-T20P	SDRT20P	HXK 5	HXK 4	12.98	
D 40090 402 N	400	290.00	400.00	272	60.00	90.00	3CT 90 402 N	US 0625	HXK 5	CN.. 1204..	US 0613-H25	HXK 2.5	HXK 5	HXK 4	12.98	
D 50090 300	500	370.00	500.00	352	60.00	90.00	3CT 90 300	US 0625	HXK 5	TC.. 16T3..	US 0415-T15P	SDRT15P	HXK 5	HXK 4	16.58	
D 50090 402	500	370.00	500.00	352	60.00	90.00	3CT 90 402	US 0625	HXK 5	CC.. 1204..	US 0513-T20P	SDRT20P	HXK 5	HXK 4	16.74	
D 50090 402 N	500	370.00	500.00	352	60.00	90.00	3CT 90 402 N	US 0625	HXK 5	CN.. 1204..	US 0613-H25	HXK 2.5	HXK 5	HXK 4	16.63	



F75

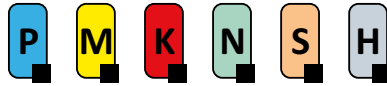

PRAMET

S



75° Finishing Boring Head, Small Bore - Ø24 up to Ø82 mm

High performance 75° small boring head for finishing. Suited for through and blind hole boring, chamfering by helical interpolation and cross hole boring. Available in CC.. and TC.. type inserts. Available for hole diameter range Ø24 up to Ø82 mm in sizes from 22 up to 42 mm. High accuracy and repeatability.

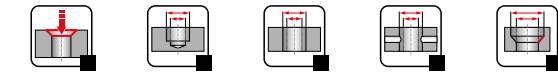
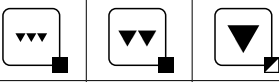
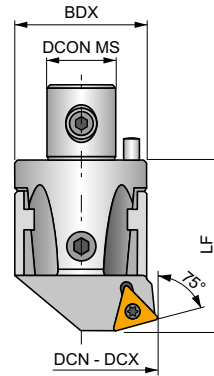

Product	CZC MS	DCN	DCX	BDX	DCON MS	LF						
		[mm]	[mm]	[mm]	[mm]	[mm]						
A 02275 400	22	24.00	30.00	22	12.00	34.00	CC.. 0602..	US 0206-T08P	SDR T08P	HXK 2	HXK 3	0.10
A 02775 401	27	29.00	40.00	27	15.00	42.00	CC.. 0803..	US 0307-T10P	SDR T10P	HXK 2	HXK 4	0.17
A 02775 409	27	29.00	40.00	27	15.00	42.00	CC.. 09T3..	US 0408-T15P	SDR T15P	HXK 2	HXK 4	0.17
A 03275 401	32	39.00	50.00	32	20.00	45.00	CC.. 0803..	US 0307-T10P	SDR T10P	HXK 2.5	HXK 4	0.26
A 03275 409	32	39.00	50.00	32	20.00	45.00	CC.. 09T3..	US 0408-T15P	SDR T15P	HXK 2.5	HXK 4	0.26
A 04275 300	42	49.00	65.00	42	24.00	56.00	TC.. 16T3..	US 0307-T10P	SDR T10P	HXK 3	HXK 5	0.51
A 05475 300	54	63.00	82.00	54	28.00	66.00	TC.. 16T3..	US 0415-T15P	SDR T15P	HXK 3	HXK 6	1.01



F75-C



PRAMET

S(P)



75° Finishing Boring Head, Medium Bore - Ø80 up to Ø220 mm

High performance 75° medium boring head for finishing. Suited for through and blind hole boring, chamfering by helical interpolation and cross hole boring. Available in CC., TC., CN.. type inserts. Available for hole diameter range Ø80 up to Ø220 mm in sizes from 68 up to 200 mm. High accuracy and repeatability.

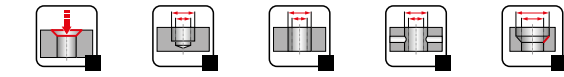
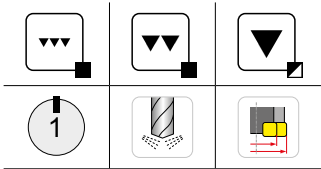
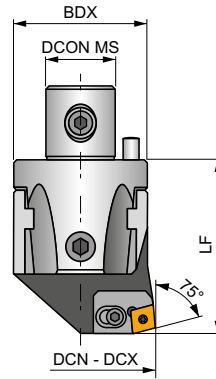

Product	CZC MS	DCN	DCX	BDX	DCON MS	LF									
A 06875 300	68	80.00	102.00	68	36.00	86.00	2CT 75 300	US 0616	HXK 5	TC.. 16T3..	US 0408-T15P	SDRT15P	HXK 5	HXK 8	2.02
A 06875 402	68	80.00	102.00	68	36.00	86.00	2CT 75 402	US 0616	HXK 5	CC.. 1204..	US 0509-T20P	SDRT20P	HXK 5	HXK 8	2.03
A 06875 402 N	68	80.00	102.00	68	36.00	86.00	2CT 75 402 N	US 0616	HXK 5	CN.. 1204..	US 0613-H25	HXK 2.5	HXK 5	HXK 8	2.04
A 08575 300	85	100.00	125.00	85	50.00	100.00	3CT 75 300	US 0625	HXK 5	TC.. 16T3..	US 0415-T15P	SDRT15P	HXK 6	HXK 8	3.89
A 08575 402	85	100.00	125.00	85	50.00	100.00	3CT 75 402	US 0625	HXK 5	CC.. 1204..	US 0513-T20P	SDRT20P	HXK 6	HXK 8	3.88
A 08575 402 N	85	100.00	125.00	85	50.00	100.00	3CT 75 402 N	US 0625	HXK 5	CN.. 1204..	US 0613-H25	HXK 2.5	HXK 6	HXK 8	3.90
A 10075 300	100	125.00	160.00	110	60.00	100.00	3CT 75 300	US 0625	HXK 5	TC.. 16T3..	US 0415-T15P	SDRT15P	HXK 6	HXK 8	6.22
A 10075 402	100	125.00	160.00	110	60.00	100.00	3CT 75 402	US 0625	HXK 5	CC.. 1204..	US 0513-T20P	SDRT20P	HXK 6	HXK 8	6.24
A 10075 402 N	100	125.00	160.00	110	60.00	100.00	3CT 75 402 N	US 0625	HXK 5	CN.. 1204..	US 0613-H25	HXK 2.5	HXK 6	HXK 8	6.25
A 20075 300	200	160.00	220.00	145	60.00	100.00	3CT 75 300	US 0625	HXK 5	TC.. 16T3..	US 0415-T15P	SDRT15P	HXK 6	HXK 8	8.30
A 20075 402	200	160.00	220.00	145	60.00	100.00	3CT 75 402	US 0625	HXK 5	CC.. 1204..	US 0513-T20P	SDRT20P	HXK 6	HXK 8	8.33
A 20075 402 N	200	160.00	220.00	145	60.00	100.00	3CT 75 402 N	US 0625	HXK 5	CN.. 1204..	US 0613-H25	HXK 2.5	HXK 6	HXK 8	8.33



F75-BB

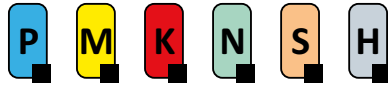

PRAMET

S(P)



75° Finishing Boring Head, Large Bore - Ø220 up to Ø500 mm

High performance 75° large boring head for finishing. Suited for through and blind hole boring, chamfering by helical interpolation and cross hole boring. Available in CC., TC., CN.. type inserts. Available for hole diameter range Ø220 up to Ø500 mm in sizes from 300 up to 500 mm. High accuracy and repeatability.

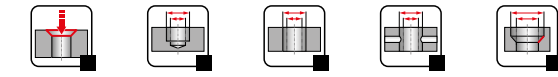
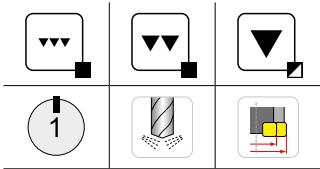
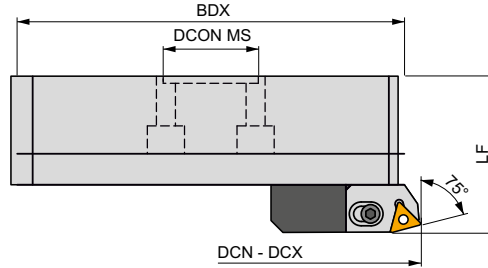

Product	CZC MS	DCN	DCX	BDX	DCON MS	LF									
		[mm]	[mm]	[mm]	[mm]	[mm]									
A 30075 300	300	220.00	320.00	202	60.00	90.00	3CT 75 300	US 0625	HXK 5	TC.. 16T3..	US 0415-T15P	SDRT15P	HXK 5	HXK 4	8.75
A 30075 402	300	220.00	320.00	202	60.00	90.00	3CT 75 402	US 0625	HXK 5	CC.. 1204..	US 0513-T20P	SDRT20P	HXK 5	HXK 4	8.75
A 30075 402 N	300	220.00	320.00	202	60.00	90.00	3CT 75 402 N	US 0625	HXK 5	CN.. 1204..	US 0613-H25	HXK 2.5	HXK 5	HXK 4	8.30
A 40075 300	400	290.00	400.00	272	60.00	90.00	3CT 75 300	US 0625	HXK 5	TC.. 16T3..	US 0415-T15P	SDRT15P	HXK 5	HXK 4	12.20
A 40075 402	400	290.00	400.00	272	60.00	90.00	3CT 75 402	US 0625	HXK 5	CC.. 1204..	US 0513-T20P	SDRT20P	HXK 5	HXK 4	12.20
A 40075 402 N	400	290.00	400.00	272	60.00	90.00	3CT 75 402 N	US 0625	HXK 5	CN.. 1204..	US 0613-H25	HXK 2.5	HXK 5	HXK 4	12.15
A 50075 300	500	370.00	500.00	352	60.00	90.00	3CT 75 300	US 0625	HXK 5	TC.. 16T3..	US 0415-T15P	SDRT15P	HXK 5	HXK 4	16.31
A 50075 402	500	370.00	500.00	352	60.00	90.00	3CT 75 402	US 0625	HXK 5	CC.. 1204..	US 0513-T20P	SDRT20P	HXK 5	HXK 4	16.31
A 50075 402 N	500	370.00	500.00	352	60.00	90.00	3CT 75 402 N	US 0625	HXK 5	CN.. 1204..	US 0613-H25	HXK 2.5	HXK 5	HXK 4	16.00



F90



PRAMET

S(P)



90° Finishing Boring Head, Small Bore - Ø24 up to Ø82 mm

High performance 90° small boring head for finishing. Suited for through, blind hole and cross hole boring. Available in CC., TC., CN.. type inserts. Available for hole diameter range Ø24 up to Ø82 mm in sizes from 22 up to 54 mm. High accuracy and repeatability.

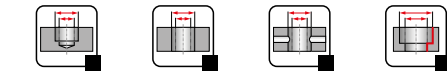
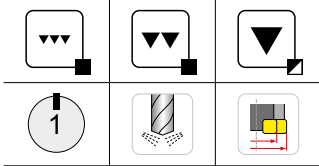
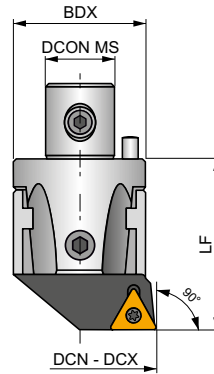

Product	CZC MS	DCN	DCX	BDX	DCON MS	LF						
		[mm]	[mm]	[mm]	[mm]	[mm]						
A 02290 400	22	24.00	30.00	22	12.00	34.00	CC.. 0602..	US 0206-T08P	SDR T08P	HXK 2	HXK 3	0.10
A 02790 401	27	29.00	40.00	27	15.00	42.00	CC.. 0803..	US 0307-T10P	SDR T10P	HXK 2	HXK 4	0.17
A 02790 409	27	29.00	40.00	27	15.00	42.00	CC.. 09T3..	US 0408-T15P	SDR T15P	HXK 2	HXK 4	0.16
A 03290 300	32	39.00	50.00	32	20.00	45.00	TC.. 16T3..	US 0408-T15P	SDR T15P	HXK 2.5	HXK 4	0.26
A 03290 401	32	39.00	50.00	32	20.00	45.00	CC.. 0803..	US 0206-T08P	SDR T08P	HXK 2.5	HXK 4	0.26
A 03290 409	32	39.00	50.00	32	20.00	45.00	CC.. 09T3..	US 0408-T15P	SDR T15P	HXK 2.5	HXK 4	0.26
A 04290 300	42	49.00	65.00	42	24.00	56.00	TC.. 16T3..	US 0415-T15P	SDR T15P	HXK 3	HXK 5	0.51
A 04290 402	42	49.00	65.00	42	24.00	56.00	CC.. 1204..	US 0513-T20P	SDR T20P	HXK 3	HXK 5	0.51
A 04290 402 N	42	49.00	65.00	42	24.00	56.00	CN.. 1204..	US 0613-H25	HXK 2.5	HXK 3	HXK 5	0.50
A 05490 300	54	63.00	82.00	54	28.00	66.00	TC.. 16T3..	US 0415-T15P	SDR T15P	HXK 3	HXK 6	1.01
A 05490 402	54	63.00	82.00	54	28.00	66.00	CC.. 1204..	US 0513-T20P	SDR T20P	HXK 3	HXK 6	1.03
A 05490 402 N	54	63.00	82.00	54	28.00	66.00	CN.. 1204..	US 0613-H25	HXK 2.5	HXK 3	HXK 6	1.01



F90-C

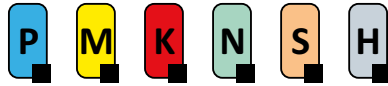

PRAMET

S(P)



90° Finishing Boring Head, Medium Bore - Ø80 up to Ø220 mm

High performance 90° medium boring head for finishing. Suited for through, blind hole and cross hole boring. Available in CC., TC., CN. type inserts. Available for hole diameter range Ø80 up to Ø220 mm in sizes from 68 up to 200 mm. High accuracy and repeatability.

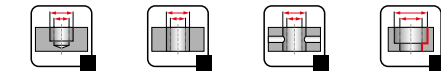
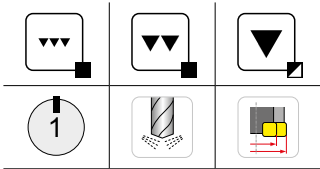
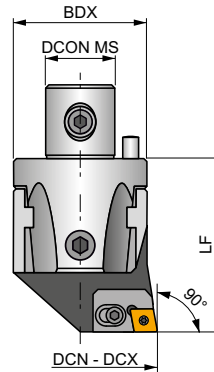

Product	CZC MS	DCN	DCX	BDX	DCON MS	LF									
		[mm]	[mm]	[mm]	[mm]	[mm]									kg
A 06890 300	68	80.00	102.00	68	36.00	86.00	2CT 90 300	US 0616	HXK 5	TC.. 16T3..	US 0408-T15P	SDR T15P	HXK 5	HXK 8	2.03
A 06890 402	68	80.00	102.00	68	36.00	86.00	2CT 90 402	US 0616	HXK 5	CC.. 1204..	US 0509-T15P	SDR T15P	HXK 5	HXK 8	2.03
A 06890 402 N	68	80.00	102.00	68	36.00	86.00	2CT 90 402 N	US 0616	HXK 5	CN.. 1204..	US 0613-H25	HXK 2.5	HXK 5	HXK 8	2.60
A 08590 300	85	100.00	125.00	85	50.00	100.00	3CT 90 300	US 0625	HXK 5	TC.. 16T3..	US 0415-T15P	SDR T15P	HXK 6	HXK 8	3.90
A 08590 402	85	100.00	125.00	85	50.00	100.00	3CT 90 402	US 0625	HXK 5	CC.. 1204..	US 0513-T20P	SDR T20P	HXK 6	HXK 8	3.88
A 08590 402 N	85	100.00	125.00	85	50.00	100.00	3CT 90 402 N	US 0625	HXK 5	CN.. 1204..	US 0613-H25	HXK 2.5	HXK 6	HXK 8	4.04
A 10090 300	100	125.00	160.00	100	60.00	100.00	3CT 90 300	US 0625	HXK 5	TC.. 16T3..	US 0415-T15P	SDR T15P	HXK 6	HXK 8	6.24
A 10090 402	100	125.00	160.00	100	60.00	100.00	3CT 90 402	US 0625	HXK 5	CC.. 1204..	US 0513-T20P	SDR T20P	HXK 6	HXK 8	6.24
A 10090 402 N	100	125.00	160.00	100	60.00	100.00	3CT 90 402 N	US 0625	HXK 5	CN.. 1204..	US 0613-H25	HXK 2.5	HXK 6	HXK 8	6.26
A 20090 300	200	160.00	220.00	200	60.00	100.00	3CT 90 300	US 0625	HXK 5	TC.. 16T3..	US 0415-T15P	SDR T15P	HXK 6	HXK 8	8.30
A 20090 402	200	160.00	220.00	200	60.00	100.00	3CT 90 402	US 0625	HXK 5	CC.. 1204..	US 0513-T20P	SDR T20P	HXK 6	HXK 8	8.29
A 20090 402 N	200	160.00	220.00	200	60.00	100.00	3CT 90 402 N	US 0625	HXK 5	CN.. 1204..	US 0613-H25	HXK 2.5	HXK 6	HXK 8	8.33



F90-BB



PRAMET

S(P)



90° Finishing Boring Head, Large Bore - Ø220 up to Ø500 mm

High performance 90° large boring head for finishing. Suited for through, blind hole and cross hole boring. Available in CC., TC., CN.. type inserts. Available for hole diameter range Ø220 up to Ø500 mm in sizes from 300 up to 500 mm. High accuracy and repeatability.

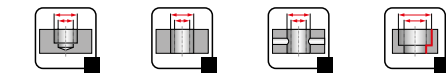
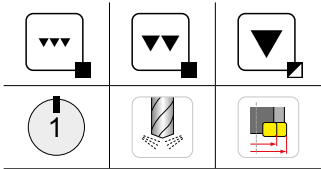
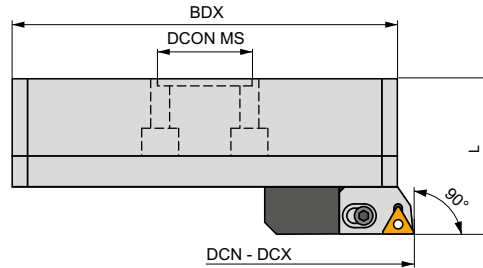

Product	CZC MS	DCN	DCX	BDX	DCON MS	LF									
		[mm]	[mm]	[mm]	[mm]	[mm]									
A 30090 300	300	220.00	320.00	300	60.00	90.00	3CT 90 300	US 0625	HXK 5	TC.. 16T3..	US 0415-T15P	SDRT15P	HXK 5	HXK 4	8.74
A 30090 402	300	220.00	320.00	300	60.00	90.00	3CT 90 402	US 0625	HXK 5	CC.. 1204..	US 0513-T20P	SDRT20P	HXK 5	HXK 4	8.82
A 30090 402 N	300	220.00	320.00	300	60.00	90.00	3CT 90 402 N	US 0625	HXK 5	CN.. 1204..	US 0613-H25	HXK 2.5	HXK 5	HXK 4	8.75
A 40090 300	400	290.00	400.00	400	60.00	90.00	3CT 90 300	US 0625	HXK 5	TC.. 16T3..	US 0415-T15P	SDRT15P	HXK 5	HXK 4	12.19
A 40090 402	400	290.00	400.00	400	60.00	90.00	3CT 90 402	US 0625	HXK 5	CC.. 1204..	US 0513-T20P	SDRT20P	HXK 5	HXK 4	12.50
A 40090 402 N	400	290.00	400.00	400	60.00	90.00	3CT 90 402 N	US 0625	HXK 5	CN.. 1204..	US 0613-H25	HXK 2.5	HXK 5	HXK 4	12.20
A 50090 300	500	370.00	500.00	500	60.00	90.00	3CT 90 300	US 0625	HXK 5	TC.. 16T3..	US 0415-T15P	SDRT15P	HXK 5	HXK 4	16.08
A 50090 402	500	370.00	500.00	500	60.00	90.00	3CT 90 402	US 0625	HXK 5	CC.. 1204..	US 0513-T20P	SDRT20P	HXK 5	HXK 4	16.20
A 50090 402 N	500	370.00	500.00	500	60.00	90.00	3CT 90 402 N	US 0625	HXK 5	CN.. 1204..	US 0613-H25	HXK 2.5	HXK 5	HXK 4	16.00



MB-H

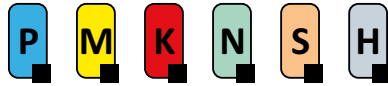

PRAMET

S



Micro Boring Head, Ultra Small Bore - Ø8 up to Ø38 mm

High performance, high accuracy micro boring head with high repeatability. Suited for through, blind, shoulder and cross hole boring. Head size can carry boring tools from Ø6.0 up to Ø16.0 mm. Available in sizes from 27 up to 42 mm.

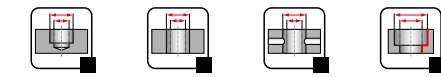
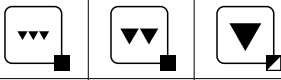
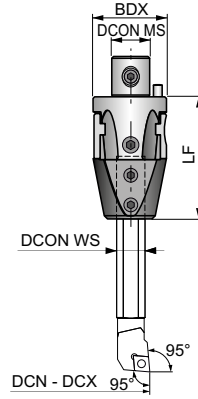

Product	CZC MS	DCN	DCX	BDX	DCON MS	DCON WS	LB			
		[mm]	[mm]	[mm]	[mm]	[mm]				
A 027 006	27	8.00	20.00	27	15.00	6.00	50.00	HXK 2	HXK 4	0.20
A 027 008	27	10.00	21.00	27	15.00	8.00	50.00	HXK 2	HXK 4	0.19
A 032 008	32	10.00	21.00	32	20.00	8.00	58.00	HXK 2.5	HXK 4	0.32
A 032 010	32	13.00	25.00	32	20.00	10.00	58.00	HXK 2.5	HXK 4	0.32
A 042 010	42	13.00	29.00	42	24.00	10.00	70.00	HXK 3	HXK 5	0.64
A 042 012	42	16.00	34.00	42	24.00	12.00	70.00	HXK 3	HXK 5	0.64
A 042 016	42	20.00	38.00	42	24.00	16.00	70.00	HXK 3	HXK 5	0.62







ISO BARS

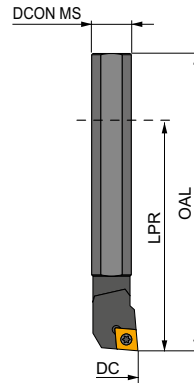

Boring Bars for Micro Boring Head - Shank Diameter Ø6 up to Ø20 mm

Suited for blind, through, shoulder and cross hole boring. Available in EP., TC.. and CC.. type inserts.



Product	DCON MS	DC	OAL	LPR				Carbide	
	[mm]	[mm]	[mm]	[mm]					
S06E SELPR 05-B	6.00	8.00	70.0	46	EP.. 0502..	US 0205-T07P	SDR T07P	–	0.04
S08F SCLCR 06-B	8.00	10.00	80.0	50	CC.. 0602..	US 0205-T08P	SDR T08P	–	0.04
S10G SCLCR 06-B	10.00	13.00	90.0	54	CC.. 0602..	US 0206-T08P	SDR T08P	–	0.06
S12H SCLCR 06-B	12.00	16.00	100.0	64	CC.. 0602..	US 0206-T08P	SDR T08P	–	0.11
S16J SCLCR 09-B	16.00	20.00	110.0	74	CC.. 09T3..	US 0408-T15P	SDR T15P	–	0.18
S16J STFCR 09-B	16.00	20.00	110.0	74	TC.. 0902..	US 0206-T07P	SDR T07P	–	0.18
S16J STFCR 16-B	16.00	20.00	110.0	74	TC.. 16T3..	US 0408-T15P	SDR T15P	–	0.18
C08G SCLCR 06	8.00	10.00	90.0	60	CC.. 0602..	US 0205-T08P	SDR T08P	✓	1.00
C10J SCLCR 06	10.00	13.00	110.0	74	CC.. 0602..	US 0206-T08P	SDR T08P	✓	0.13
C12K SCLCR 06	12.00	16.00	125.0	89	CC.. 0602..	US 0206-T08P	SDR T08P	✓	0.20
C16L SCLCR 09	16.00	20.00	140.0	104	CC.. 09T3..	US 0408-T15P	SDR T15P	✓	0.38



ISO BARS A042



Boring Bars for Micro A042 Micro Boring Head

Boring bars with oversized shank diameter $\varnothing 16$ mm. Suited for blind, through, shoulder and cross hole boring. Available in EP., TC.. and CC.. type inserts.

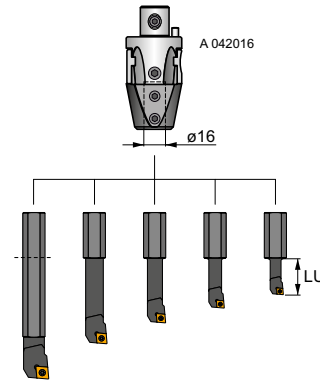

Product	DCN	DCX	LU				
	[mm]	[mm]	[mm]				
S06/16 SELPR 05	8.00	26.00	25.00	EP.. 0502..	US 0205-T07P	SDR T07P	0.08
S06/16 STFCR 06	8.00	26.00	25.00	TC.. 06T1..	US 0405-T06P	SDR T06P	0.08
S08/16 SCLCR 06	10.00	28.00	35.00	CC.. 0602..	US 0205-T08P	SDR T08P	0.09
S08/16 STFCR 06	10.00	28.00	35.00	TC.. 06T1..	US 0405-T06P	SDR T06P	0.07
S10/16 SCLCR 06	13.00	31.00	45.00	CC.. 0602..	US 0206-T08P	SDR T08P	0.10
S10/16 STFCR 09	13.00	31.00	45.00	TC.. 0902..	US 0206-T07P	SDR T07P	0.10
S12/16 SCLCR 06	16.00	34.00	57.00	CC.. 0602..	US 0206-T08P	SDR T08P	0.13
S12/16 STFCR 09	16.00	34.00	57.00	TC.. 0902..	US 0206-T07P	SDR T07P	0.13
S16/16 SCLCR 09	20.00	38.00	73.00	CC.. 09T3..	US 0408-T15P	SDR T15P	0.18
S16/16 STFCR 09	20.00	38.00	73.00	TC.. 0902..	US 0206-T07P	SDR T07P	0.18
S16/16 STFCR 16	20.00	38.00	73.00	TC.. 0902..	US 0408-T15P	SDR T15P	0.18



BORING ACCESSORIES



ACCESSORIES - CARTRIDGES DESCRIPTION

1	2	3	4
2CT	90	402 N	S

1	2	3	4
Type of tool	Cutting edge angle	Inserts pocket code	Variant
2CT	30	300 TC..16T3.	S Staggered
3CT	45	402 CC..1204..	
	75	402N CN..1204..	
	90		



Symmetrical boring

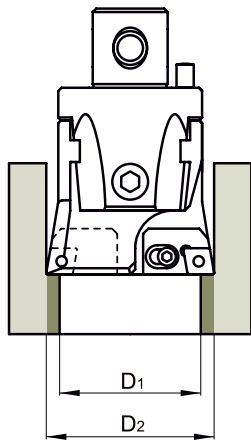

2CT □□ □□□ + 2CT □□ □□□
 3CT □□ □□□ + 3CT □□ □□□

Staggered boring

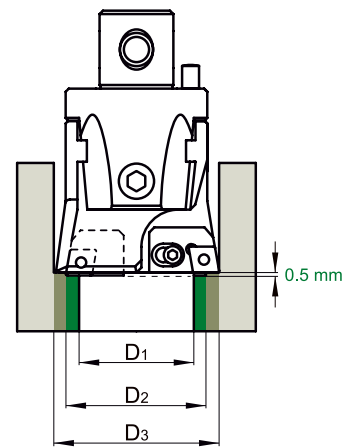

2CT □□ □□□ S + 2CT □□ □□□
 3CT □□ □□□ S + 3CT □□ □□□



CART-BS-SPC

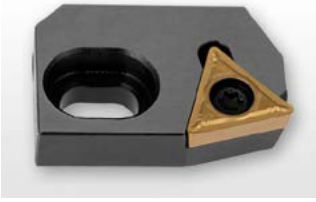
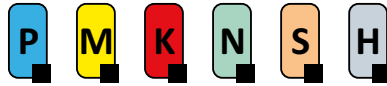

Special Boring Head 2CT and 3CT Cartridges

Special boring head cartridges, sizes 2CT and 3CT available in different approach angles 30° or 45°. Suited for TC., CC., CN.. inserts for rough and finishing boring applications.

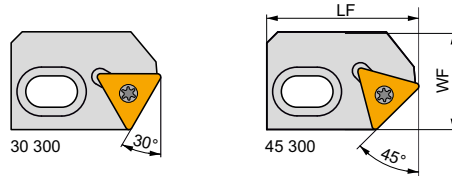

Product	WF	LF									
	[mm]	[mm]									
2CT 30 300	22.5	35.00	US 0616	HXK 5	US 0430	HXK 2	TC.. 16T3..	US 0408-T15P	SDR T15P	0.59	
2CT 45 300	22.5	35.00	US 0616	HXK 5	US 0430	HXK 2	TC.. 16T3..	US 0408-T15P	SDR T15P	0.05	
2CT 90 300 S	23	33.00	US 0616	HXK 5	US 0430	HXK 2	TC.. 16T3..	US 0408-T15P	SDR T15P	0.05	
2CT 90 402 N S	23	33.00	US 0616	HXK 5	US 0430	HXK 2	CN.. 1204.. L	US 0613-H25	HXK 2.5	0.07	
2CT 90 402 S	23	33.00	US 0616	HXK 5	US 0430	HXK 2	CC.. 1204..	US 0509-T20P	SDR T20P	0.05	
3CT 30 300	28	39.00	US 0625	HXK 5	US 0635	HXK 3	TC.. 16T3..	US 0415-T15P	SDR T15P	0.10	
3CT 45 300	28	39.00	US 0625	HXK 5	US 0635	HXK 3	TC.. 16T3..	US 0415-T15P	SDR T15P	0.10	
3CT 90 300 S	28.5	37.00	US 0625	HXK 5	US 0635	HXK 3	TC.. 16T3..	US 0415-T15P	SDR T15P	0.10	
3CT 90 402 N S	28.5	37.00	US 0625	HXK 5	US 0635	HXK 3	CN.. 1204.. L	US 0613-H25	HXK 2.5	0.11	
3CT 90 402 S	28.5	37.00	US 0625	HXK 5	US 0635	HXK 3	CC.. 1204..	US 0513-T20P	SDR T20P	0.09	



CART-BS-STD

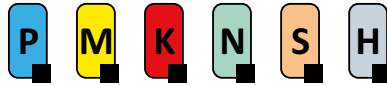

Standard Boring Head 2CT and 3CT Cartridges

Standard boring head cartridges, sizes 2CT and 3CT available in different approach angles 75° or 90°. Suited for TC., CC., CN.. inserts for rough and finishing boring applications.

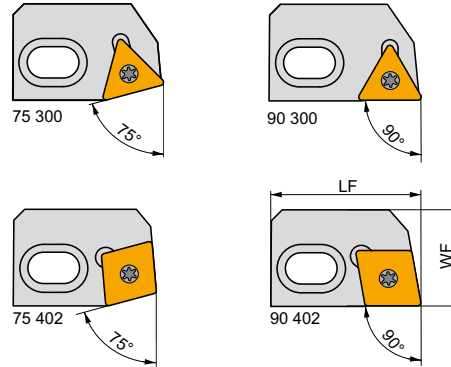

Product	WF	LF								
	[mm]	[mm]								
2CT 75 300	22.5	35.00	US 0616	HXK 5	US 0430	HXK 2	TC.. 16T3..	US 0408-T15P	SDR T15P	0.06
2CT 75 402	22.5	35.00	US 0616	HXK 5	US 0430	HXK 2	CC.. 1204..	US 0509-T20P	SDR T20P	0.06
2CT 75 402 N	22.5	35.00	US 0616	HXK 5	US 0430	HXK 2	CN.. 1204.. R	US 0613-H25	HXK 2.5	0.07
2CT 90 300	22.5	35.00	US 0616	HXK 5	US 0430	HXK 2	TC.. 16T3..	US 0408-T15P	SDR T15P	0.05
2CT 90 402	22.5	35.00	US 0616	HXK 5	US 0430	HXK 2	CC.. 1204..	US 0509-T20P	SDR T20P	0.05
2CT 90 402 N	22.5	35.00	US 0616	HXK 5	US 0430	HXK 2	CN.. 1204.. L	US 0613-H25	HXK 2.5	0.07
3CT 75 300	28	39.00	US 0625	HXK 5	US 0635	HXK 3	TC.. 16T3..	US 0415-T15P	SDR T15P	0.10
3CT 75 402	28	39.00	US 0625	HXK 5	US 0635	HXK 3	CC.. 1204..	US 0509-T20P	SDR T20P	0.10
3CT 75 402 N	28	39.00	US 0625	HXK 5	US 0635	HXK 3	CN.. 1204.. R	US 0613-H25	HXK 2.5	0.12
3CT 90 300	28	39.00	US 0625	HXK 5	US 0635	HXK 3	TC.. 16T3..	US 0415-T15P	SDR T15P	0.11
3CT 90 402	28	39.00	US 0625	HXK 5	US 0635	HXK 3	CC.. 1204..	US 0509-T20P	SDR T20P	0.10
3CT 90 402 N	28	39.00	US 0625	HXK 5	US 0635	HXK 3	CN.. 1204.. L	US 0613-H25	HXK 2.5	0.12



CHAM-BS

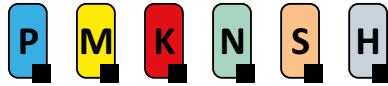

PRAMET

S



CH-BS Chamfering Ring for Boring Heads

45° chamfering ring for boring head system, sizes from 22 up to 42 mm to hold DC.. 11T3.. Inserts, and sizes from 54 up to 200 mm to hold DC.. 1504.. inserts.

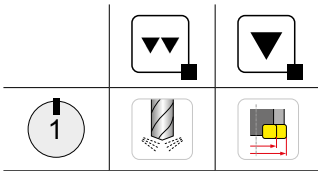
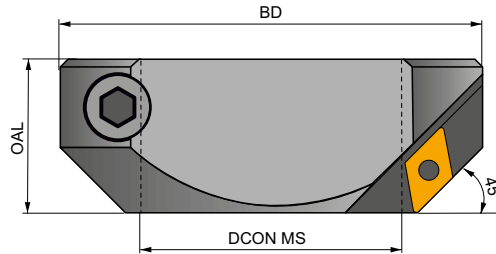

















Product	CZC MS	DCON MS	BD	OAL					
		[mm]	[mm]	[mm]					
CH 022	22	22.00	43.00	24.0	DC.. 11T3..	US 0408-T15P	SDRT15P	HXK 4	0.11
CH 027	27	27.00	48.00	24.0	DC.. 11T3..	US 0408-T15P	SDRT15P	HXK 4	0.13
CH 032	32	32.00	62.00	30.0	DC.. 11T3..	US 0408-T15P	SDRT15P	HXK 5	0.29
CH 042	42	42.00	72.00	30.0	DC.. 11T3..	US 0408-T15P	SDRT15P	HXK 5	0.38
CH 054	54	54.00	94.00	40.0	DC.. 1504..	US 0513-T20P	SDRT20P	HXK 6	0.89
CH 068	68	68.00	110.00	40.0	DC.. 1504..	US 0513-T20P	SDRT20P	HXK 8	1.23
CH 085	85	85.00	145.00	55.0	DC.. 1504..	US 0513-T20P	SDRT20P	HXK 10	2.70
CH 100	100	100.00	170.00	60.0	DC.. 1504..	US 0513-T20P	SDRT20P	HXK 14	4.14
CH 200	200	200.00	200.00	60.0	DC.. 1504..	US 0513-T20P	SDRT20P	HXK 14	5.80



BORING INSERTS







BORING INSERTS – NAVIGATOR

CCGT  388	CCGW CBN  390	CCMT  390	CCMW  393
CNGA CBN  394	CNGG  395	CNMA  395	CNMG  396
DCMT  398	DCMW  399	DCMW PCD  399	
EPGX  400	EPMT  400		
TCGT  401	TCMT  402	TCMW  403	

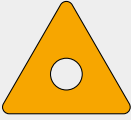
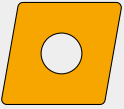

INDEXABLE CUTTING INSERTS

Shape	Pocket designation	ISO code
	300	TC.. 16T3..
	400 401 402 409	CC.. 0602.. CC.. 0803.. CC.. 1204.. CC.. 09T3..
	402N	CN.. 1204..
		EP.. 0502..
		DC.. 11T3.. DC.. 1504..

More options on inserts can be found in catalogue turning. Details about geometries can also be found in boring insert section.



BORING GRADES – NAVIGATOR

Grade Identification	Area of Application	Application	Feed	Cutting speed	Resistance to adverse Working Conditions	Coating	Colour	Substrate	Coolant benefit	Grade description
T9315	P05 - P25	■				MT-CVD	FGM	FGM	++	A versatile grade with excellent wear resistance properties even under intense cutting conditions. It can also be used for operations with interrupted cuts. With its well balanced properties this grade can be first choice for a wide range of turning operations. Not suited to low cutting speeds.
	K05 - K25	■	▴	▴	▴					
	H10 - H20	■								
T9325	P15 - P35	■				MT-CVD	FGM	FGM	++	From a technological perspective this is an extremely versatile grade with high resistance to mechanical damage in adverse cutting conditions and retains excellent wear resistance. The correct application of this material requires high cutting speeds.
	M10 - M30	■	▴	▴	▴					
	K15 - K35	■	▴	▴	▴					
	S10 - S20	■								
T9335	P20 - P45	■				MT-CVD	FGM	FGM	+++	One of the toughest grades which is especially suitable for adverse cutting conditions at medium to high feed rates and medium cutting speeds. Compared to its predecessors, M15 – M40 it is not only tougher, but also more abrasion resistant which will be useful when using intensive cutting conditions.
	M15 - M40	■	▴	▴	▴					
	S15 - S25	■								
T7325	P15 - P35	■				MT-CVD	FGM	FGM	+++	One of the most universal turning grades. Especially designed for stainless steel machining. Optimal balance between wear resistance and performance reliability. Suitable for broad variety of application in turning operations.
	M10 - M25	■	▴	▴	▴					
	S10 - S25	■								
T7335	P20 - P40	■				MT-CVD	FGM	FGM	+++	Grade with functionally graded substrate, featuring very high operational reliability and very good wear-resistance. It is best suited to use in the machining of very tough M20 – M40 materials.
	M20 - M40	■	▴	▴	▴					
	S15 - S25	■								
T5305	P05 - P15	■				MT-CVD	H	H	+	Grade with very high resistance to chemical wear; suitable for finishing operations using high cutting speeds. With its high abrasion resistance, it is also suitable for productive K01 – K15, machining of hardened and treated materials.
	K01 - K15	■	▴	▴	▴					
	H05 - H15	■								
T5315	P10 - P25	■				MT-CVD	H	H	+	Grade intended primarily for productive machining which has high abrasion resistance and good operational reliability. Due to its properties, this material is particularly suitable for roughing and finishing operations for good or slightly adverse cutting conditions.
	K10 - K25	■	▴	▴	▴					
	H15 - H25	■								
T8315	P05 - P20	■				PVD	Submicron H	Submicron H	++	Grade featuring excellent abrasion resistance while maintaining above average operational reliability, it is suitable for machining at medium to high cutting speeds in short chipping harder materials.
	M05 - M20	■	▴	▴	▴					
	K05 - K25	■	▴	▴	▴					
	N05 - N25	■								
	S05 - S15	■								
T8330	P25 - P40	■				PVD	Submicron H	Submicron H	+++	Undoubtedly the most versatile cutting material, this is useful for machining of all types of machined materials and is practically applicable in almost all types of turning operations. Its main benefits are its high operational reliability and very good frictional properties; it is therefore suitable for applications at medium and lower cutting speeds.
	M20 - M35	■	▴	▴	▴					
	K20 - K40	■	▴	▴	▴					
	N15 - N30	■								
	S15 - S25	■								
T6310	P01 - P15	■				PVD	Ultra submicron H	Ultra submicron H	+++	High wear resistant turning grade with top PVD coating. Suitable for finishing operation and applications, where sharp cutting edge together with high flank wear resistance is of high importance
	M01 - M15	■	▴	▴	▴					
	K05 - K20	■	▴	▴	▴					
	N05 - N20	■								
	S01 - S15	■								



BORING GRADES – NAVIGATOR

Grade Identification	Area of Application	Application	Feed	Cutting speed	Resistance to adverse Working Conditions	Coating	Colour	Substrate	Coolant benefit	Grade description
T0315	N05 - N20	■				PVD			++	Submicron grade for turning non-ferrous metals and their alloys with a balance of wear resistance and toughness. It is provided with a unique coating with excellent friction properties.
HF7	M10 - M20	■				×		submicron H	++	Uncoated grade which is primarily designed for machining non-ferrous metals; but can also be used for other machined materials (except steel). This material can be used in turning, milling, and even boring.
	K10 - K25	■								
	N10 - N25	■								
H07	M05 - M15	■				×		submicron H	++	Uncoated turning grade suitable for machining applications where oxidation resistance is not dominating criterion of tool life. Designed for machining of Ti-based alloys. Grade exhibits high strength of cutting edge together with good wear resistance.
	K10 - K25	■								
	N10 - N30	■								
	S01 - S20	■								
TT310	P10 - P25	■				PVD		cermet	+ / -	Coated cermet used for fine and finish turning of carbon and alloy steels (including stainless). Its excellent friction properties are further improved by the coating applied using the PVD technique.
	M15 - M25	■								
TT010	P01 - P10	■				×		cermet	+ / -	Uncoated cermet, which is suitable for fine machining of all types of steel (including stainless) at very low feed rates. Its main advantage is the minimal radius of the cutting edge and its high resistance to physical and chemical wear mechanisms.
	M01 - M10	■								
PD1	N05 - N25	■				×		PKD	-	PKD grade for turning non-ferrous materials. Ideal choice for working with high cutting speed and small feeds at stable conditions.
TB310	K01 - K10	■				×		CBN	--	CBN grade for machining of hardened materials. Suitable for machining with high cutting speed and small feeds at stable conditions.
	S05 - S10	■								
	H01 - H10	■								

Substrat	
H	WC-Co based substrate
submicron H	WC-Co based substrate fine grained (< 1 μm)
ultra submicron H	WC-Co based substrate very fine grained (< 0.5 μm)
FGM	Functionally graded substrate
Cermet	Cemented carbide without WC
PCD	Polycrystalline Diamond
CBN	Cubic Boron Nitride

Coating	
MT-CVD	Medium-temperature chemical method of coating
PVD	Low-temperature physical method of coating
×	Uncoated grade

Benefits of cutting fluid	
+++	Use of coolant is essential
++	Highly recommended
+ / -	Optional
--	Do not use coolant

ISO CODE DESIGNATION – INSERTS

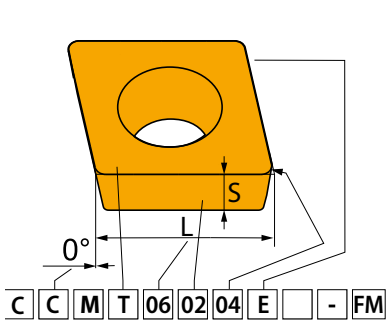

ISO	1	2	3	4
	C	C	M	T
ANSI	1	2	3	4
	C	C	M	T

1				2				4			
Insert shape				Insert clearance angle				Insert type			
H	O	P	R	A	B	N	R	F	A	M	G
S	T	C	D	C	D	T	Q	U	B	H	C
E	M	V	W	E	F	J	X				
L	A	B	K	G	O						
				P							

3 3 Tolerances

	[mm]			["]		
	M(±)	S(±)	IC(±)	M(±)	S(±)	IC(±)
A	0.005	0.025	0.025	.0002"	.001"	.0010"
F	0.005	0.025	0.013	.0002"	.001"	.0005"
C	0.013	0.025	0.025	.0005"	.001"	.0010"
H	0.013	0.025	0.013	.0005"	.001"	.0005"
E	0.025	0.025	0.025	.0010"	.001"	.0010"
G	0.025	0.130	0.025	.0010"	.005"	.0010"
J	0.005	0.025	0.05 – 0.13	.0002"	.001"	.002 – 0.005"
K	0.013	0.025	0.05 – 0.13	.0005"	.001"	.002 – 0.005"
L	0.025	0.025	0.05 – 0.13	.0010"	.001"	.002 – 0.005"
M	0.08 – 0.18	0.130	0.05 – 0.13	.003 – 0.007"	.005"	.002 – 0.005"
N	0.08 – 0.18	0.025	0.05 – 0.13	.003 – 0.007"	.001"	.002 – 0.005"
U	0.05 – 0.38	0.130	0.05 – 0.13	.005 – 0.015"	.005"	.003 – 0.010"

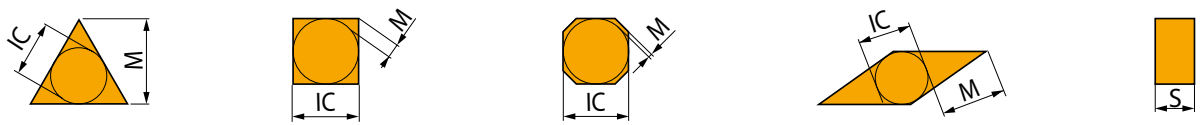



ISO CODE DESIGNATION – INSERTS

5	6	7	8	9	10
06	02	04	E	-	FM
5	6	7	8	9	10
2	1.5	1	E	-	FM

5		5												
Insert cutting edge length (insert size)														
d = IC		H	O	P	S	T	C	D	E	M	V	W	R	K
[mm]	[in]													
3.97	5/32"				03	06		04			06	02		
4.76	3/16"				04	08	04	05	04	04	08	L3		
5.56	7/32"				05	09	05	06	05	05	09	03		
6.35	1/4"	03	02	04	08	11	06	07	08	08	11	04	06	
7.94	5/16"	04	03	05	07	13	08	09	06	07	13	05	07	
9.525	3/8"	05	04	07	09	16	09	11	09	09	16	06	09	16
12.7	1/2"	07	05	09	12	22	12	15	13	12	22	08	12	
15.875	5/8"	09	06	11	15	27	16	19	16	15	27	10	15	
19.05	3/4"	11	07	13	19	33	19	23	19	19	33	13	19	
25.40	1"	14	10	18	25	44	25	31	26	25	44	17	25	
31.75	1 1/4"	18	13	23	31	54	32	38	32	31	54	21	31	

6		7	
Insert thickness		Insert nose radius	
	S		RE
	[mm]	[mm]	["]
01	1.59	00	0
T1	1.98	02	0.2
02	2.38	04	0.4
03	3.18	08	0.8
T3	3.97	12	1.2
04	4.76	16	1.6
05	5.56	24	2.4
06	6.35	32	3.2
07	7.94		
09	9.52		

7		8	
Insert cutting edge design		Insert cutting edge design	
	F		E
	T		S
	K		P
	Sharp edges		Rounded edges
	Edges with facet		Rounded edges with facet
	Edges with double facet		Rounded edges with double facet

ANSI					
5		6		7	
Inscribed circle		Insert thickness		Insert nose radius	
d = I.C.		S		RE	
Symbol	[mm]	[mm]	["]	[mm]	["]
1	3.175	1	1.588	0	0
1.2	3.969	1.2	1.984	0.2	0.099
1.5	4.763	1.5	2.381	0.5	0.198
1.8	5.556	2	3.175	1	0.397
2	6.350	2.5	3.969	2	0.794
2.5	7.938	3	4.763	3	1.191
3	9.525	3.5	5.556	4	1.588
4	12.700	4	6.350	5	1.984
5	15.875	5	7.938	6	2.381
6	19.050	6	9.525	7	2.778
7	22.225	7	11.113	8	3.175
8	25.400	8	12.700	10	3.969
10	31.750	9	14.288	12	4.763
12	38.100	10	15.875	14	5.556
				16	6.350

9		9	
Feed direction		Feed direction	
R		N	
L			

10 10

Chip breaker designation



CCGT



	IC	D1	L	S
	[mm]	[mm]	[mm]	[mm]
0602	6.350	2.80	6.40	2.38
0602-SF3	6.350	2.80	6.40	2.58
0803-AL	7.940	3.40	8.10	3.43
0803-SF3	7.940	3.40	8.10	3.43
09T3	9.525	4.40	9.70	3.97
09T3-SF3	9.525	4.40	9.70	4.22
1204	12.700	5.50	12.90	4.76
1204-SF3	12.700	5.50	12.90	5.01

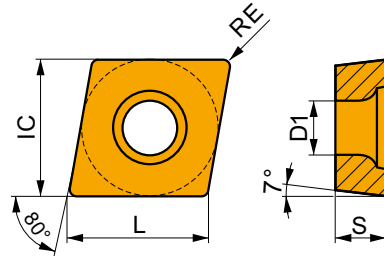

Suitability and starting values for cutting speed (vc), feed (f) and depth of cut (ap). Refer to our Machining Calculator app for further calculations.

Product	RE	P			M			K			N			S			H		
		vc	f	ap	vc	f	ap	vc	f	ap	vc	f	ap	vc	f	ap	vc	f	ap
	[mm]	[m/min]	[mm/rev]	[mm]	[m/min]	[mm/rev]	[mm]	[m/min]	[mm/rev]	[mm]	[m/min]	[mm/rev]	[mm]	[m/min]	[mm/rev]	[mm]	[m/min]	[mm/rev]	[mm]



AL geometry with highly positive design for fine-finish to rough machining, continuous to slightly interrupted cuts.

CCGT 060202F-AL	HF7	0.2	-	-	-	-	-	-	-	-	-	360	0.12	1.0	-	-	-	-	-	-
	T0315	0.2	-	-	-	-	-	-	-	-	-	360	0.12	1.0	-	-	-	-	-	-
CCGT 060204F-AL	HF7	0.4	-	-	-	-	-	-	-	-	-	300	0.24	1.0	-	-	-	-	-	-
	T0315	0.4	-	-	-	-	-	-	-	-	-	300	0.24	1.0	-	-	-	-	-	-
CCGT 080302F-AL	T0315	0.2	-	-	-	-	-	-	-	-	-	360	0.12	1.0	-	-	-	-	-	-
CCGT 080304F-AL	HF7	0.4	-	-	-	-	-	-	-	-	-	300	0.24	1.0	-	-	-	-	-	-
	T0315	0.4	-	-	-	-	-	-	-	-	-	300	0.24	1.0	-	-	-	-	-	-
CCGT 09T302F-AL	HF7	0.2	-	-	-	-	-	-	-	-	-	360	0.12	1.0	-	-	-	-	-	-
	T0315	0.2	-	-	-	-	-	-	-	-	-	360	0.12	1.0	-	-	-	-	-	-
CCGT 09T304F-AL	HF7	0.4	-	-	-	-	-	-	-	-	-	300	0.24	1.5	-	-	-	-	-	-
	T0315	0.4	-	-	-	-	-	-	-	-	-	300	0.24	1.5	-	-	-	-	-	-
CCGT 09T308F-AL	HF7	0.8	-	-	-	-	-	-	-	-	-	200	0.48	1.5	-	-	-	-	-	-
	T0315	0.8	-	-	-	-	-	-	-	-	-	200	0.48	1.5	-	-	-	-	-	-
CCGT 120404F-AL	HF7	0.4	-	-	-	-	-	-	-	-	-	300	0.24	2.4	-	-	-	-	-	-
	T0315	0.4	-	-	-	-	-	-	-	-	-	300	0.24	2.4	-	-	-	-	-	-
CCGT 120408F-AL	HF7	0.8	-	-	-	-	-	-	-	-	-	200	0.48	2.4	-	-	-	-	-	-
	T0315	0.8	-	-	-	-	-	-	-	-	-	200	0.48	2.4	-	-	-	-	-	-

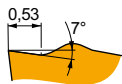

FF2 geometry with positive design for fine-finish to finish machining, continuous to slightly interrupted cuts.

CCGT 09T302E-FF2	T7325	0.2	150	0.05	1.0	-	-	-	-	-	-	-	-	-	-	-	-	-	-	-
	T9325	0.2	150	0.05	1.0	-	-	-	115	0.05	1.0	-	-	-	-	-	-	-	-	-

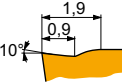

NF1 geometry with positive design for fine-finish to medium machining and continuous cuts.

CCGT 060204E-NF1	T6310	0.4	140	0.10	0.8	110	0.09	0.8	-	-	-	360	0.12	0.8	38	0.07	0.6	25	0.15	1.0
	T7325	0.4	140	0.10	0.8	110	0.09	0.8	-	-	-	-	-	-	45	0.07	0.6	-	-	-
CCGT 060208E-NF1	T6310	0.8	140	0.12	0.8	110	0.11	0.8	-	-	-	360	0.14	0.8	45	0.11	0.6	30	0.15	1.0
	T7325	0.8	140	0.12	0.8	110	0.11	0.8	-	-	-	-	-	-	45	0.11	0.6	-	-	-
CCGT 09T304E-NF1	T6310	0.4	140	0.10	1.2	110	0.09	1.2	-	-	-	360	0.12	1.2	38	0.07	1.0	25	0.15	1.0
	T7325	0.4	140	0.10	1.2	110	0.09	1.2	-	-	-	-	-	-	45	0.07	1.0	-	-	-
CCGT 09T308E-NF1	T6310	0.8	140	0.14	1.2	100	0.13	1.2	-	-	-	330	0.17	1.2	41	0.13	1.0	25	0.15	1.0
	T7325	0.8	140	0.14	1.2	100	0.13	1.2	-	-	-	-	-	-	45	0.13	1.0	-	-	-



Suitability and starting values for cutting speed (vc), feed (f) and depth of cut (ap). Refer to our Machining Calculator app for further calculations.

Product	RE [mm]	P			M			K			N			S			H		
		vc [m/min]	f [mm/rev]	ap [mm]	vc [m/min]	f [mm/rev]	ap [mm]	vc [m/min]	f [mm/rev]	ap [mm]	vc [m/min]	f [mm/rev]	ap [mm]	vc [m/min]	f [mm/rev]	ap [mm]	vc [m/min]	f [mm/rev]	ap [mm]

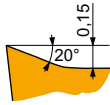

SF3 geometry with highly positive design for fine to finish machining, and continuous cuts.

CCGT 060202E-SF3	H07	0.2	–	–	–	█	110	0.05	0.8	█	115	0.05	0.8	█	360	0.06	0.8	█	45	0.04	0.6	–	–	–		
	T6310	0.2	█	150	0.05	0.8	█	110	0.05	0.8	█	115	0.05	0.8	█	360	0.06	0.8	█	45	0.04	0.6	█	30	0.15	1.0
	T8315	0.2	█	150	0.05	0.8	█	110	0.05	0.8	█	115	0.05	0.8	█	360	0.06	0.8	█	38	0.04	0.6	█	30	0.15	1.0
CCGT 060204E-SF3	H07	0.4	–	–	–	█	95	0.09	0.8	█	115	0.10	0.8	█	360	0.12	0.8	█	34	0.07	0.6	–	–	–		
	T6310	0.4	█	140	0.10	0.8	█	110	0.09	0.8	█	115	0.10	0.8	█	360	0.12	0.8	█	38	0.07	0.6	█	26	0.15	1.0
	T8315	0.4	█	140	0.10	0.8	█	110	0.09	0.8	█	115	0.10	0.8	█	360	0.12	0.8	█	34	0.07	0.6	█	26	0.15	1.0
CCGT 080302E-SF3	T6310	0.2	█	150	0.05	0.8	█	110	0.05	0.8	█	115	0.05	0.8	█	360	0.06	0.8	█	45	0.04	0.6	█	30	0.15	1.0
	T8315	0.2	█	150	0.05	0.8	█	110	0.05	0.8	█	115	0.05	0.8	█	360	0.06	0.8	█	38	0.04	0.6	█	30	0.15	1.0
CCGT 080304E-SF3	H07	0.4	–	–	–	█	95	0.09	1.0	█	115	0.10	1.0	█	360	0.12	1.0	█	34	0.07	0.8	–	–	–		
	T6310	0.4	█	140	0.10	1.0	█	110	0.09	1.0	█	115	0.10	1.0	█	360	0.12	1.0	█	38	0.07	0.8	█	26	0.15	1.0
	T8315	0.4	█	140	0.10	1.0	█	110	0.09	1.0	█	115	0.10	1.0	█	360	0.12	1.0	█	34	0.07	0.8	█	26	0.15	1.0
CCGT 09T302E-SF3	H07	0.2	–	–	–	█	110	0.05	0.8	█	115	0.05	0.8	█	360	0.06	0.8	█	45	0.04	0.6	–	–	–		
	T6310	0.2	█	150	0.05	0.8	█	110	0.05	0.8	█	115	0.05	0.8	█	360	0.06	0.8	█	45	0.04	0.6	█	30	0.15	1.0
	T8315	0.2	█	150	0.05	0.8	█	110	0.05	0.8	█	115	0.05	0.8	█	360	0.06	0.8	█	38	0.04	0.6	█	30	0.15	1.0
CCGT 09T304E-SF3	H07	0.4	–	–	–	█	95	0.09	1.0	█	115	0.10	1.0	█	360	0.12	1.0	█	34	0.07	0.8	–	–	–		
	T6310	0.4	█	140	0.10	1.0	█	110	0.09	1.0	█	115	0.10	1.0	█	360	0.12	1.0	█	38	0.07	0.8	█	26	0.15	1.0
	T8315	0.4	█	140	0.10	1.0	█	110	0.09	1.0	█	115	0.10	1.0	█	360	0.12	1.0	█	34	0.07	0.8	█	26	0.15	1.0
CCGT 09T308E-SF3	H07	0.8	–	–	–	█	110	0.09	1.0	█	115	0.10	1.0	█	360	0.12	1.0	█	41	0.08	0.8	–	–	–		
	T6310	0.8	█	140	0.10	1.0	█	110	0.09	1.0	█	115	0.10	1.0	█	360	0.12	1.0	█	45	0.08	0.8	█	30	0.15	1.0
	T8315	0.8	█	140	0.10	1.0	█	110	0.09	1.0	█	115	0.10	1.0	█	360	0.12	1.0	█	41	0.08	0.8	█	34	0.15	1.0
CCGT 120408E-SF3	H07	0.8	–	–	–	█	105	0.12	1.0	█	110	0.12	1.0	█	360	0.14	1.0	█	38	0.11	0.8	–	–	–		
	T6310	0.8	█	140	0.12	1.0	█	110	0.12	1.0	█	110	0.12	1.0	█	360	0.14	1.0	█	45	0.11	0.8	█	30	0.15	1.0
	T8315	0.8	█	140	0.12	1.0	█	110	0.12	1.0	█	110	0.12	1.0	█	360	0.14	1.0	█	38	0.11	0.8	█	30	0.15	1.0

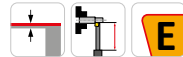

EL-SI geometry with positive left-handed design for fine-finish machining, and continuous cuts.

CCGT 060202EL-SI	T8330	0.2	█	140	0.10	0.8	█	110	0.09	0.8	█	115	0.10	0.8	–	–	–	█	38	0.08	0.6	–	–	–
	T8430	0.2	█	140	0.10	0.8	█	110	0.09	0.8	█	115	0.10	0.8	–	–	–	█	38	0.08	0.6	–	–	–
CCGT 060204EL-SI	T8315	0.4	█	140	0.12	0.8	█	110	0.11	0.8	█	110	0.12	0.8	–	–	–	█	41	0.10	0.6	–	–	–
	T8330	0.4	█	140	0.12	0.8	█	110	0.11	0.8	█	110	0.12	0.8	–	–	–	█	38	0.10	0.6	–	–	–
CCGT 09T304EL-SI	T8430	0.4	█	140	0.12	0.8	█	110	0.11	0.8	█	110	0.12	0.8	–	–	–	█	38	0.10	0.6	–	–	–
	T8315	0.4	█	130	0.17	0.8	█	100	0.15	0.8	█	105	0.17	0.8	–	–	–	█	38	0.15	0.6	–	–	–
CCGT 120408EL-SI	T8330	0.4	█	130	0.17	0.8	█	100	0.15	0.8	█	105	0.17	0.8	–	–	–	█	34	0.15	0.6	–	–	–
	T8430	0.4	█	130	0.17	0.8	█	100	0.15	0.8	█	105	0.17	0.8	–	–	–	█	34	0.15	0.6	–	–	–
	T8330	0.8	█	130	0.23	1.0	█	95	0.21	1.0	█	95	0.23	1.0	–	–	–	█	38	0.21	0.8	–	–	–
T8430	0.8	█	130	0.24	1.0	█	95	0.22	1.0	█	95	0.24	1.0	–	–	–	█	34	0.22	0.8	–	–	–	



CCGW CBN

PRAMET

	IC	D1	L	S
	[mm]	[mm]	[mm]	[mm]
0602	6.350	2.80	6.50	2.38
09T3	9.525	4.50	9.70	3.97

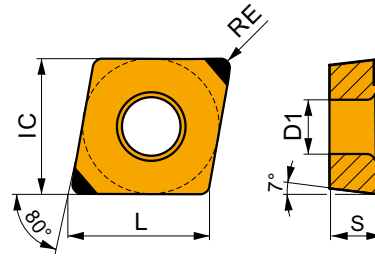

Suitability and starting values for cutting speed (vc), feed (f) and depth of cut (ap). Refer to our Machining Calculator app for further calculations.

Product	RE	P			M			K			N			S			H		
		vc	f	ap	vc	f	ap	vc	f	ap	vc	f	ap	vc	f	ap	vc	f	ap
	[mm]	[m/min]	[mm/rev]	[mm]	[m/min]	[mm/rev]	[mm]	[m/min]	[mm/rev]	[mm]	[m/min]	[mm/rev]	[mm]	[m/min]	[mm/rev]	[mm]	[m/min]	[mm/rev]	[mm]

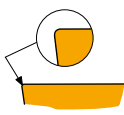

For finish machining.

CCGW 060204E-B	TB310	0.4	-	-	-	-	-	-	115	0.10	0.4	-	-	-	90	0.07	0.3	70	0.15	1.0
CCGW 09T304E-B	TB310	0.4	-	-	-	-	-	-	115	0.10	0.4	-	-	-	90	0.07	0.3	70	0.15	1.0

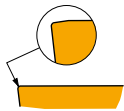

For finish machining.

CCGW 060204S01020B	TB310	0.4	-	-	-	-	-	-	115	0.10	0.4	-	-	-	90	0.07	0.3	70	0.15	1.0
CCGW 09T304S01020B	TB310	0.4	-	-	-	-	-	-	115	0.10	0.4	-	-	-	90	0.07	0.3	70	0.15	1.0

CCMT

PRAMET

	IC	D1	L	S
	[mm]	[mm]	[mm]	[mm]
0602	6.350	2.80	6.40	2.38
0803	7.940	3.40	8.10	3.18
09T3	9.525	4.40	9.70	3.97
1204	12.700	5.50	12.90	4.76

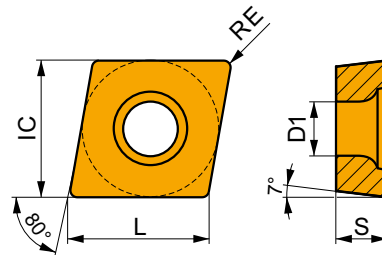

Suitability and starting values for cutting speed (vc), feed (f) and depth of cut (ap). Refer to our Machining Calculator app for further calculations.

Product	RE	P			M			K			N			S			H		
		vc	f	ap	vc	f	ap	vc	f	ap	vc	f	ap	vc	f	ap	vc	f	ap
	[mm]	[m/min]	[mm/rev]	[mm]	[m/min]	[mm/rev]	[mm]	[m/min]	[mm/rev]	[mm]	[m/min]	[mm/rev]	[mm]	[m/min]	[mm/rev]	[mm]	[m/min]	[mm/rev]	[mm]

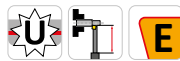
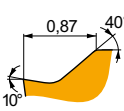

FF geometry with positive design for fine-finish to finish machining, and continuous to slightly interrupted cuts.

CCMT 060202E-FF	T8330	0.2	140	0.10	1.0	110	0.09	1.0	-	-	-	-	-	-	-	-	-	-	-	-
	T8430	0.2	140	0.10	1.0	110	0.09	1.0	-	-	-	-	-	-	-	-	-	-	-	-
CCMT 060204E-FF	T8330	0.4	140	0.12	1.0	110	0.11	1.0	-	-	-	-	-	-	-	-	-	-	-	-
	T8430	0.4	140	0.12	1.0	110	0.11	1.0	-	-	-	-	-	-	-	-	-	-	-	-
CCMT 09T304E-FF	T8330	0.4	140	0.12	1.2	110	0.11	1.2	-	-	-	-	-	-	-	-	-	-	-	-
	T8430	0.4	140	0.12	1.2	110	0.11	1.2	-	-	-	-	-	-	-	-	-	-	-	-



Suitability and starting values for cutting speed (vc), feed (f) and depth of cut (ap). Refer to our Machining Calculator app for further calculations.

Product	RE [mm]	P			M			K			N			S			H		
		vc	f	ap	vc	f	ap	vc	f	ap	vc	f	ap	vc	f	ap	vc	f	ap
		[m/min]	[mm/rev]	[mm]	[m/min]	[mm/rev]	[mm]	[m/min]	[mm/rev]	[mm]	[m/min]	[mm/rev]	[mm]	[m/min]	[mm/rev]	[mm]	[m/min]	[mm/rev]	[mm]

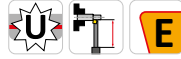
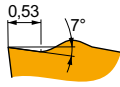

FF2 geometry with positive design for fine-finish to finish machining, and continuous to slightly interrupted cuts.

CCMT 060202E-FF2	T8330	0.2	150	0.05	0.8	-	-	-	115	0.05	0.8	-	-	-	-	-	-	-
	T8430	0.2	150	0.05	0.8	-	-	-	115	0.05	0.8	-	-	-	-	-	-	-
	T9325	0.2	150	0.05	0.8	-	-	-	115	0.05	0.8	-	-	-	-	-	-	-
	TT010	0.2	150	0.05	0.5	-	-	-	-	-	-	-	-	-	-	-	-	-
CCMT 060204E-FF2	T8330	0.4	140	0.12	1.0	-	-	-	110	0.12	1.0	-	-	-	-	-	-	-
	T8430	0.4	140	0.12	1.0	-	-	-	110	0.12	1.0	-	-	-	-	-	-	-
	T9325	0.4	140	0.12	1.0	-	-	-	110	0.12	1.0	-	-	-	-	-	-	-
	TT010	0.4	140	0.12	0.5	-	-	-	-	-	-	-	-	-	-	-	-	-
CCMT 080302E-FF2	T8330	0.2	150	0.05	0.8	-	-	-	115	0.05	0.8	-	-	-	-	-	-	-
	T8430	0.2	150	0.05	0.8	-	-	-	115	0.05	0.8	-	-	-	-	-	-	-
	T9325	0.2	150	0.05	0.8	-	-	-	115	0.05	0.8	-	-	-	-	-	-	-
	TT010	0.2	150	0.05	0.5	-	-	-	-	-	-	-	-	-	-	-	-	-
CCMT 080304E-FF2	T8330	0.4	140	0.12	1.0	-	-	-	110	0.12	1.0	-	-	-	-	-	-	-
	T8430	0.4	140	0.12	1.0	-	-	-	110	0.12	1.0	-	-	-	-	-	-	-
	T9325	0.4	140	0.12	1.0	-	-	-	110	0.12	1.0	-	-	-	-	-	-	-
	TT010	0.4	150	0.06	0.5	-	-	-	-	-	-	-	-	-	-	-	-	-
CCMT 080308E-FF2	T8330	0.8	130	0.17	1.0	-	-	-	105	0.17	1.0	-	-	-	-	-	-	-
	T8430	0.8	130	0.17	1.0	-	-	-	105	0.17	1.0	-	-	-	-	-	-	-
	T9325	0.8	130	0.17	1.0	-	-	-	105	0.17	1.0	-	-	-	-	-	-	-
CCMT 09T304E-FF2	T8330	0.4	140	0.12	1.2	-	-	-	110	0.12	1.2	-	-	-	-	-	-	-
	T8430	0.4	140	0.12	1.2	-	-	-	110	0.12	1.2	-	-	-	-	-	-	-
	T9325	0.4	140	0.12	1.2	-	-	-	110	0.12	1.2	-	-	-	-	-	-	-
	TT010	0.4	150	0.06	0.5	-	-	-	-	-	-	-	-	-	-	-	-	-
CCMT 09T308E-FF2	T8330	0.8	130	0.17	1.2	-	-	-	105	0.17	1.2	-	-	-	-	-	-	-
	T8430	0.8	130	0.17	1.2	-	-	-	105	0.17	1.2	-	-	-	-	-	-	-
	T9325	0.8	130	0.17	1.2	-	-	-	105	0.17	1.2	-	-	-	-	-	-	-
	TT010	0.8	140	0.10	0.8	-	-	-	-	-	-	-	-	-	-	-	-	-

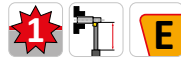

FM geometry for finish to semi-rough machining, and continuous to slightly interrupted cuts.

CCMT 060202E-FM	T8330	0.2	140	0.10	1.0	110	0.09	1.0	115	0.10	1.0	360	0.12	1.0	-	-	-	-
	T8430	0.2	140	0.10	1.0	110	0.09	1.0	115	0.10	1.0	360	0.12	1.0	-	-	-	-
	T9325	0.2	140	0.10	1.0	110	0.09	1.0	115	0.10	1.0	-	-	-	-	-	-	-
CCMT 060204E-FM	T8330	0.4	140	0.15	1.0	100	0.14	1.0	110	0.15	1.0	330	0.18	1.0	-	-	-	-
	T8430	0.4	140	0.15	1.0	100	0.14	1.0	110	0.15	1.0	330	0.18	1.0	-	-	-	-
	T9325	0.4	140	0.15	1.0	100	0.15	1.0	110	0.15	1.0	-	-	-	-	-	-	-
CCMT 060208E-FM	T8330	0.8	130	0.20	1.0	100	0.18	1.0	100	0.20	1.0	300	0.24	1.0	-	-	-	-
	T8430	0.8	130	0.20	1.0	100	0.18	1.0	100	0.20	1.0	300	0.24	1.0	-	-	-	-
	T9325	0.8	130	0.20	1.0	100	0.18	1.0	100	0.20	1.0	-	-	-	-	-	-	-
CCMT 09T302E-FM	T8330	0.2	140	0.10	1.2	105	0.09	1.2	115	0.10	1.2	360	0.12	1.2	-	-	-	-
	T8430	0.2	140	0.10	1.2	110	0.09	1.2	115	0.10	1.2	360	0.12	1.2	-	-	-	-
	T9325	0.2	140	0.10	1.2	110	0.09	1.2	115	0.10	1.2	-	-	-	-	-	-	-
CCMT 09T304E-FM	T8330	0.4	140	0.15	1.2	100	0.14	1.2	110	0.15	1.2	330	0.18	1.2	-	-	-	-
	T8430	0.4	140	0.15	1.2	100	0.14	1.2	110	0.15	1.2	330	0.18	1.2	-	-	-	-
	T9325	0.4	140	0.15	1.2	100	0.15	1.2	110	0.15	1.2	-	-	-	-	-	-	-
CCMT 09T308E-FM	T8330	0.8	130	0.20	1.2	100	0.18	1.2	100	0.20	1.2	300	0.24	1.2	-	-	-	-
	T8430	0.8	130	0.20	1.2	100	0.18	1.2	100	0.20	1.2	300	0.24	1.2	-	-	-	-
	T9325	0.8	130	0.20	1.2	100	0.18	1.2	100	0.20	1.2	-	-	-	-	-	-	-
CCMT 120404E-FM	T8330	0.4	140	0.15	1.7	95	0.14	1.7	110	0.15	1.7	330	0.18	1.7	-	-	-	-
	T8430	0.4	140	0.15	1.7	100	0.14	1.7	110	0.15	1.7	330	0.18	1.7	-	-	-	-
	T9325	0.4	140	0.15	1.7	100	0.15	1.7	110	0.15	1.7	-	-	-	-	-	-	-
CCMT 120408E-FM	T8330	0.8	130	0.20	1.7	100	0.18	1.7	100	0.20	1.7	300	0.24	1.7	-	-	-	-
	T8430	0.8	130	0.20	1.7	100	0.18	1.7	100	0.20	1.7	300	0.24	1.7	-	-	-	-
	T9325	0.8	130	0.20	1.7	100	0.18	1.7	100	0.20	1.7	-	-	-	-	-	-	-



Suitability and starting values for cutting speed (vc), feed (f) and depth of cut (ap). Refer to our Machining Calculator app for further calculations.

Product	RE (mm)	P			M			K			N			S			H		
		vc (m/min)	f (mm/rev)	ap (mm)	vc (m/min)	f (mm/rev)	ap (mm)	vc (m/min)	f (mm/rev)	ap (mm)	vc (m/min)	f (mm/rev)	ap (mm)	vc (m/min)	f (mm/rev)	ap (mm)	vc (m/min)	f (mm/rev)	ap (mm)

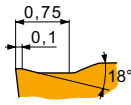

FM2 geometry for finish to medium machining, and continuous to interrupted cuts.

CCMT 080304E-FM2	T8330	0.4	140	0.12	1.0	95	0.11	1.0	110	0.12	1.0	-	-	-	-	-	-	-
	T8430	0.4	140	0.12	1.0	105	0.11	1.0	110	0.12	1.0	-	-	-	-	-	-	-
	T9325	0.4	140	0.12	1.0	110	0.11	1.0	110	0.12	1.0	-	-	-	-	-	-	-
CCMT 080308E-FM2	T8330	0.8	130	0.17	1.0	100	0.15	1.0	105	0.17	1.0	-	-	-	-	-	-	-
	T8430	0.8	130	0.17	1.0	100	0.15	1.0	105	0.17	1.0	-	-	-	-	-	-	-
	T9325	0.8	130	0.17	1.0	100	0.15	1.0	105	0.17	1.0	-	-	-	-	-	-	-
CCMT 09T304E-FM2	T8330	0.4	140	0.12	1.0	95	0.11	1.0	110	0.12	1.0	-	-	-	-	-	-	-
	T8430	0.4	140	0.12	1.0	105	0.11	1.0	110	0.12	1.0	-	-	-	-	-	-	-
	T9325	0.4	140	0.12	1.0	110	0.11	1.0	110	0.12	1.0	-	-	-	-	-	-	-
CCMT 09T308E-FM2	T8330	0.8	130	0.17	1.0	100	0.15	1.0	105	0.17	1.0	-	-	-	-	-	-	-
	T8430	0.8	130	0.17	1.0	100	0.15	1.0	105	0.17	1.0	-	-	-	-	-	-	-
	T9325	0.8	130	0.17	1.0	100	0.15	1.0	105	0.17	1.0	-	-	-	-	-	-	-
CCMT 120408E-FM2	T8330	0.8	130	0.20	1.5	95	0.18	1.5	100	0.20	1.5	-	-	-	-	-	-	-
	T8430	0.8	130	0.20	1.5	95	0.18	1.5	100	0.20	1.5	-	-	-	-	-	-	-
	T9325	0.8	130	0.20	1.5	100	0.18	1.5	100	0.20	1.5	-	-	-	-	-	-	-

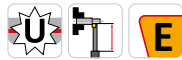

NF2 geometry with positive design for fine-finish to semi-rough machining, and continuous cuts.

CCMT 060202E-NF2	T6310	0.2	140	0.10	0.8	110	0.09	0.8	115	0.10	0.8	360	0.12	0.8	38	0.08	0.6	-	-	-
	T9325	0.2	140	0.10	0.8	110	0.09	0.8	115	0.10	0.8	-	-	-	41	0.08	0.6	-	-	-
CCMT 060204E-NF2	H07	0.4	-	-	-	85	0.11	0.8	110	0.12	0.8	360	0.14	0.8	34	0.11	0.6	-	-	-
	T6310	0.4	140	0.12	0.8	110	0.11	0.8	110	0.12	0.8	360	0.14	0.8	38	0.11	0.6	-	-	-
CCMT 080304E-NF2	T9325	0.4	140	0.12	1.0	110	0.11	1.0	110	0.12	1.0	-	-	-	41	0.11	0.8	-	-	-
	T9325	0.8	130	0.17	1.0	100	0.15	1.0	105	0.17	1.0	-	-	-	41	0.14	0.8	-	-	-
CCMT 09T304E-NF2	H07	0.4	-	-	-	85	0.11	1.2	110	0.12	1.2	360	0.14	1.2	30	0.11	1.0	-	-	-
	T6310	0.4	140	0.12	1.2	110	0.11	1.2	110	0.12	1.2	360	0.14	1.2	34	0.11	1.0	-	-	-
	T9325	0.4	140	0.12	1.2	110	0.11	1.2	110	0.12	1.2	-	-	-	41	0.11	1.0	-	-	-
CCMT 09T308E-NF2	T6310	0.8	140	0.14	1.2	100	0.13	1.2	110	0.14	1.2	330	0.17	1.2	41	0.13	1.0	-	-	-
	T9325	0.8	140	0.14	1.2	100	0.13	1.2	110	0.14	1.2	-	-	-	45	0.13	1.0	-	-	-

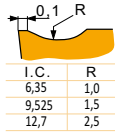

RF geometry for semi-rough to rough machining, and continuous to interrupted cuts.

CCMT 060202E-RF	T7335	0.2	140	0.15	1.0	100	0.14	1.0	-	-	-	-	-	-	-	-	-	-	-	
CCMT 060204E-RF	T5315	0.4	140	0.15	1.0	-	-	-	110	0.15	1.0	-	-	-	-	-	-	35	0.15	1.0
	T7335	0.4	140	0.15	1.0	100	0.15	1.0	-	-	-	-	-	-	-	-	-	-	-	
CCMT 09T304E-RF	T7335	0.4	130	0.20	1.5	100	0.18	1.5	-	-	-	-	-	-	-	-	-	-	-	
CCMT 09T308E-RF	T5315	0.8	130	0.20	1.5	-	-	-	100	0.20	1.5	-	-	-	-	-	-	35	0.15	1.0
	T7335	0.8	130	0.20	1.5	100	0.18	1.5	-	-	-	-	-	-	-	-	-	-	-	
CCMT 120408E-RF	T5315	0.8	130	0.22	2.2	-	-	-	100	0.22	2.2	-	-	-	-	-	-	35	0.15	1.0
	T7335	0.8	130	0.22	2.2	95	0.22	2.2	-	-	-	-	-	-	-	-	-	-	-	

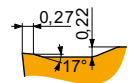
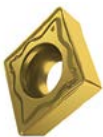

RM geometry for semi-rough machining, and continuous to interrupted cuts.

CCMT 09T304E-RM	T8330	0.4	120	0.27	2.2	80	0.24	2.2	95	0.27	2.2	-	-	-	26	0.19	1.8	20	0.15	1.0
	T8430	0.4	120	0.27	2.2	75	0.24	2.2	95	0.27	2.2	-	-	-	23	0.19	1.8	19	0.15	1.0
	T9325	0.4	120	0.27	2.2	95	0.24	2.2	95	0.27	2.2	-	-	-	30	0.19	1.8	-	-	-
CCMT 09T308E-RM	T8330	0.8	120	0.30	2.2	90	0.27	2.2	90	0.30	2.2	-	-	-	30	0.24	1.8	23	0.15	1.0
	T8430	0.8	120	0.30	2.2	90	0.27	2.2	90	0.30	2.2	-	-	-	26	0.24	1.8	23	0.15	1.0
	T9325	0.8	120	0.30	2.2	90	0.27	2.2	90	0.30	2.2	-	-	-	34	0.24	1.8	-	-	-



Suitability and starting values for cutting speed (vc), feed (f) and depth of cut (ap). Refer to our Machining Calculator app for further calculations.

Product	RE [mm]	P			M			K			N			S			H		
		vc [m/min]	f [mm/rev]	ap [mm]	vc [m/min]	f [mm/rev]	ap [mm]	vc [m/min]	f [mm/rev]	ap [mm]	vc [m/min]	f [mm/rev]	ap [mm]	vc [m/min]	f [mm/rev]	ap [mm]	vc [m/min]	f [mm/rev]	ap [mm]

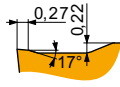
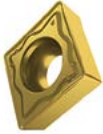

RM geometry for semi-rough machining, and continuous to interrupted cuts.

CCMT 120408E-RM	T8330	0.8	120	0.30	2.7	90	0.27	2.7	90	0.30	2.7	-	-	-	30	0.24	2.2	23	0.15	1.0
	T8430	0.8	120	0.30	2.7	90	0.27	2.7	90	0.30	2.7	-	-	-	26	0.24	2.2	23	0.15	1.0
	T9325	0.8	120	0.30	2.7	90	0.27	2.7	90	0.30	2.7	-	-	-	34	0.24	2.2	-	-	-

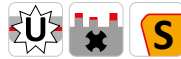
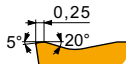
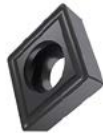

RM3 geometry for semi-rough to rough machining, and continuous to interrupted cuts.

CCMT 120404E-RM3	T9325	0.4	120	0.25	2.5	95	0.25	2.5	95	0.25	2.5	-	-	-	-	-	-	-	-	-
CCMT 120408E-RM3	T6310	0.8	120	0.27	2.5	90	0.27	2.5	95	0.27	2.5	-	-	-	-	-	-	19	0.15	1.0
	T9325	0.8	120	0.27	2.5	90	0.27	2.5	95	0.27	2.5	-	-	-	-	-	-	-	-	-

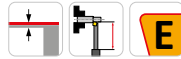
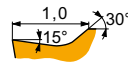

UR geometry for fine to finish machining, and continuous to slightly interrupted cuts.

CCMT 060202E-UR	T8330	0.2	140	0.10	0.8	95	0.09	0.8	115	0.10	0.8	-	-	-	-	-	-	-	-	-
	TT310	0.2	140	0.10	0.5	110	0.09	0.5	-	-	-	-	-	-	-	-	-	-	-	-
CCMT 060204E-UR	T8330	0.4	140	0.15	1.0	90	0.14	1.0	110	0.15	1.0	-	-	-	-	-	-	-	-	-
	TT310	0.4	140	0.15	0.5	100	0.14	0.5	-	-	-	-	-	-	-	-	-	-	-	-
CCMT 060208E-UR	T8330	0.8	130	0.20	1.0	95	0.18	1.0	100	0.20	1.0	-	-	-	-	-	-	-	-	-
CCMT 09T302E-UR	TT310	0.2	140	0.10	1.0	110	0.09	1.0	-	-	-	-	-	-	-	-	-	-	-	-
CCMT 09T304E-UR	T8330	0.4	140	0.15	1.2	90	0.14	1.2	110	0.15	1.2	-	-	-	-	-	-	-	-	-
	TT310	0.4	140	0.15	1.2	100	0.14	1.2	-	-	-	-	-	-	-	-	-	-	-	-
CCMT 09T308E-UR	T8330	0.8	130	0.20	1.2	95	0.18	1.2	100	0.20	1.2	-	-	-	-	-	-	-	-	-
	TT310	0.8	130	0.20	1.2	100	0.18	1.2	-	-	-	-	-	-	-	-	-	-	-	-
CCMT 120404E-UR	T8330	0.4	140	0.15	1.7	80	0.14	1.7	110	0.15	1.7	-	-	-	-	-	-	-	-	-
CCMT 120408E-UR	T8330	0.8	130	0.20	1.7	90	0.18	1.7	100	0.20	1.7	-	-	-	-	-	-	-	-	-

CCMW



	IC [mm]	D1 [mm]	L [mm]	S [mm]
0602	6.350	2.80	6.40	2.38
09T3	9.525	4.40	9.70	3.97
1204	12.700	5.50	12.90	4.76

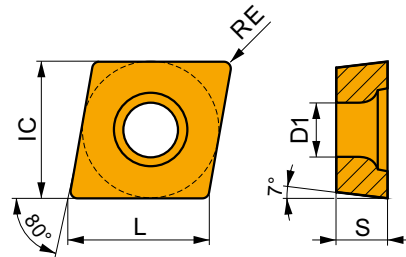

Suitability and starting values for cutting speed (vc), feed (f) and depth of cut (ap). Refer to our Machining Calculator app for further calculations.

Product	RE [mm]	P			M			K			N			S			H		
		vc [m/min]	f [mm/rev]	ap [mm]	vc [m/min]	f [mm/rev]	ap [mm]	vc [m/min]	f [mm/rev]	ap [mm]	vc [m/min]	f [mm/rev]	ap [mm]	vc [m/min]	f [mm/rev]	ap [mm]	vc [m/min]	f [mm/rev]	ap [mm]

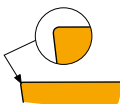

For fine-finish to semi-rough machining, and continuous to slightly interrupted cuts.

CCMW 060204	T5315	0.4	-	-	-	-	-	-	115	0.10	2.0	-	-	-	-	-	-	30	0.15	1.0
CCMW 09T304	T5315	0.4	-	-	-	-	-	-	115	0.10	3.0	-	-	-	-	-	-	30	0.15	1.0
CCMW 09T308	T5315	0.8	-	-	-	-	-	-	100	0.20	3.0	-	-	-	-	-	-	26	0.15	1.0



Suitability and starting values for cutting speed (vc), feed (f) and depth of cut (ap). Refer to our Machining Calculator app for further calculations.

Product	RE [mm]	P			M			K			N			S			H		
		vc [m/min]	f [mm/rev]	ap [mm]	vc [m/min]	f [mm/rev]	ap [mm]	vc [m/min]	f [mm/rev]	ap [mm]	vc [m/min]	f [mm/rev]	ap [mm]	vc [m/min]	f [mm/rev]	ap [mm]	vc [m/min]	f [mm/rev]	ap [mm]

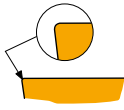
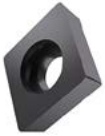

For fine-finish to semi-rough machining, and continuous to slightly interrupted cuts.

CCMW 120404	T5315	0.4	-	-	-	-	-	-	115	0.10	4.0	-	-	-	-	-	-	26	0.15	1.0
CCMW 120408	T5315	0.8	-	-	-	-	-	-	100	0.20	4.0	-	-	-	-	-	-	26	0.15	1.0

CNGA CBN

PRAMET

	IC [mm]	D1 [mm]	L [mm]	S [mm]
1204	12.700	5.16	12.90	4.76

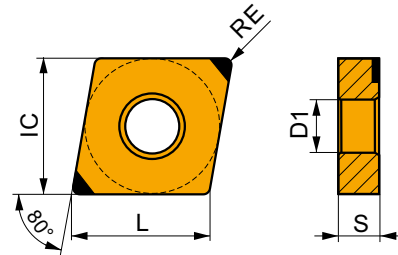

Suitability and starting values for cutting speed (vc), feed (f) and depth of cut (ap). Refer to our Machining Calculator app for further calculations.

Product	RE [mm]	P			M			K			N			S			H		
		vc [m/min]	f [mm/rev]	ap [mm]	vc [m/min]	f [mm/rev]	ap [mm]	vc [m/min]	f [mm/rev]	ap [mm]	vc [m/min]	f [mm/rev]	ap [mm]	vc [m/min]	f [mm/rev]	ap [mm]	vc [m/min]	f [mm/rev]	ap [mm]

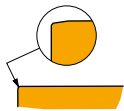

For finish machining and continuous cuts.

CNGA 120404S01020B	TB310	0.4	-	-	-	-	-	-	115	0.10	0.4	-	-	-	100	0.07	0.3	80	0.15	1.0
CNGA 120408S01020B	TB310	0.8	-	-	-	-	-	-	110	0.15	0.6	-	-	-	100	0.11	0.5	85	0.15	1.0



CNGG

	IC	D1	L	S
	[mm]	[mm]	[mm]	[mm]
1204	12.700	5.16	12.90	4.76

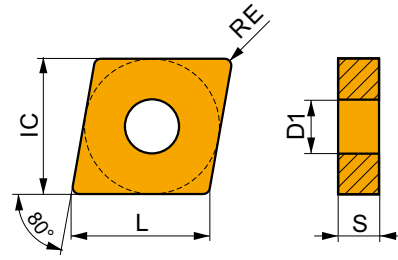

Suitability and starting values for cutting speed (vc), feed (f) and depth of cut (ap). Refer to our Machining Calculator app for further calculations.

Product	RE	P			M			K			N			S			H		
		vc	f	ap	vc	f	ap	vc	f	ap	vc	f	ap	vc	f	ap	vc	f	ap
	[mm]	[m/min]	[mm/rev]	[mm]	[m/min]	[mm/rev]	[mm]	[m/min]	[mm/rev]	[mm]	[m/min]	[mm/rev]	[mm]	[m/min]	[mm/rev]	[mm]	[m/min]	[mm/rev]	[mm]

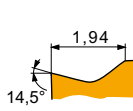

SF geometry with positive design for fine-finish machining of thin walls in continuous cuts.

CNGG 120402E-SF	H07	0.2	–	–	–	105	0.09	1.0	115	0.10	1.0	360	0.12	1.0	38	0.08	0.8	–	–	–
	T6310	0.2	140	0.10	1.0	110	0.09	1.0	115	0.10	1.0	360	0.12	1.0	41	0.08	0.8	26	0.15	1.0
	T8330	0.2	140	0.10	1.0	110	0.09	1.0	115	0.10	1.0	360	0.12	1.0	34	0.08	0.8	26	0.15	1.0
	T8430	0.2	140	0.10	1.0	110	0.09	1.0	115	0.10	1.0	360	0.12	1.0	34	0.08	0.8	30	0.15	1.0

CNMA

	IC	D1	L	S
	[mm]	[mm]	[mm]	[mm]
1204	12.700	5.16	12.90	4.76

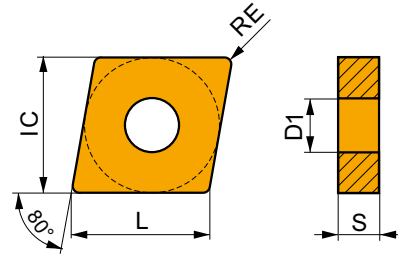

Suitability and starting values for cutting speed (vc), feed (f) and depth of cut (ap). Refer to our Machining Calculator app for further calculations.

Product	RE	P			M			K			N			S			H		
		vc	f	ap	vc	f	ap	vc	f	ap	vc	f	ap	vc	f	ap	vc	f	ap
	[mm]	[m/min]	[mm/rev]	[mm]	[m/min]	[mm/rev]	[mm]	[m/min]	[mm/rev]	[mm]	[m/min]	[mm/rev]	[mm]	[m/min]	[mm/rev]	[mm]	[m/min]	[mm/rev]	[mm]

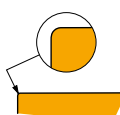

For fine-finish to semi-rough machining, and continuous to slightly interrupted cuts.

CNMA 120404	T5315	0.4	–	–	–	–	–	–	115	0.10	4.0	–	–	–	–	–	–	30	0.15	1.0
CNMA 120408	T5315	0.8	–	–	–	–	–	–	100	0.20	4.0	–	–	–	–	–	–	30	0.15	1.0
CNMA 120412	T5315	1.2	–	–	–	–	–	–	90	0.30	4.0	–	–	–	–	–	–	25	0.15	1.0



CNMG

	IC	D1	L	S
	[mm]	[mm]	[mm]	[mm]
1204	12.700	5.16	12.90	4.76

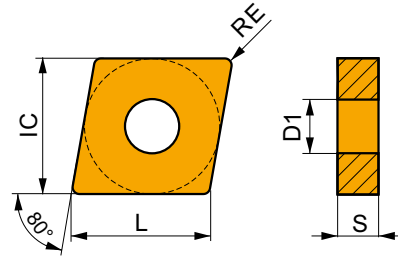

Suitability and starting values for cutting speed (vc), feed (f) and depth of cut (ap). Refer to our Machining Calculator app for further calculations.

Product	RE	P			M			K			N			S			H		
		vc	f	ap	vc	f	ap	vc	f	ap	vc	f	ap	vc	f	ap	vc	f	ap
	[mm]	[m/min]	[mm/rev]	[mm]	[m/min]	[mm/rev]	[mm]	[m/min]	[mm/rev]	[mm]	[m/min]	[mm/rev]	[mm]	[m/min]	[mm/rev]	[mm]	[m/min]	[mm/rev]	[mm]

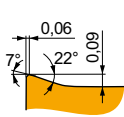

FF geometry with highly positive design for fine-finish machining, and continuous to slightly interrupted cuts.

CNMG 120404E-FF	T7325	0.4	140	0.12	1.0	110	0.11	1.0	-	-	-	-	-	-	-	-	-	-	-
	T8315	0.4	140	0.12	1.0	110	0.11	1.0	110	0.12	1.0	-	-	-	-	-	-	-	-
CNMG 120408E-FF	T7325	0.8	140	0.15	1.0	100	0.14	1.0	-	-	-	-	-	-	-	-	-	-	-
	T8315	0.8	140	0.15	1.0	100	0.14	1.0	110	0.15	1.0	-	-	-	-	-	-	-	-

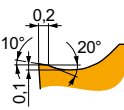

FM geometry with positive design for finish to semi-rough machining, and continuous to slightly interrupted cuts.

CNMG 120404E-FM	T9325	0.4	130	0.20	2.1	100	0.18	2.1	100	0.20	2.1	-	-	-	38	0.16	1.7	-	-	-
	TT310	0.4	130	0.20	2.1	100	0.18	2.1	-	-	-	-	-	-	-	-	-	-	-	-
CNMG 120408E-FM	T9325	0.8	130	0.20	2.1	100	0.18	2.1	100	0.20	2.1	-	-	-	45	0.16	1.7	-	-	-
	TT310	0.8	130	0.20	2.1	100	0.18	2.1	-	-	-	-	-	-	-	-	-	-	-	-

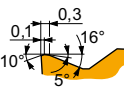

M geometry for finish to semi-rough machining, and continuous to interrupted cuts.

CNMG 120404E-M	T5315	0.4	130	0.20	2.1	-	-	-	100	0.20	2.1	-	-	-	-	-	-	35	0.15	1.0
	T9325	0.4	130	0.20	2.1	-	-	-	100	0.20	2.1	-	-	-	-	-	-	-	-	-
CNMG 120408E-M	T5315	0.8	120	0.32	2.1	-	-	-	90	0.32	2.1	-	-	-	-	-	-	38	0.15	1.0
	T9325	0.8	120	0.32	2.1	-	-	-	90	0.32	2.1	-	-	-	-	-	-	-	-	-

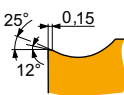

NF geometry with highly positive design for fine-finish to medium machining, and continuous cuts.

CNMG 120404E-NF	T7325	0.4	130	0.18	1.7	100	0.16	1.7	-	-	-	-	-	45	0.16	1.4	-	-	-	
	T8330	0.4	130	0.17	1.7	100	0.15	1.7	105	0.17	1.7	330	0.20	1.7	34	0.14	1.4	-	-	-
	T8430	0.4	130	0.17	1.7	100	0.15	1.7	105	0.17	1.7	330	0.20	1.7	30	0.14	1.4	-	-	-
CNMG 120408E-NF	T7325	0.8	130	0.19	1.7	100	0.17	1.7	-	-	-	-	-	45	0.15	1.4	-	-	-	
	T8330	0.8	130	0.19	1.7	100	0.17	1.7	100	0.19	1.7	300	0.23	1.7	38	0.15	1.4	-	-	-
	T8430	0.8	130	0.19	1.7	100	0.17	1.7	100	0.19	1.7	300	0.23	1.7	34	0.15	1.4	-	-	-

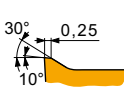









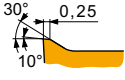

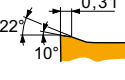



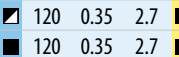

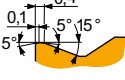

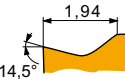

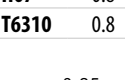
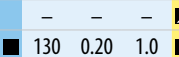
NM geometry with highly positive design for fine-finish, medium and rough machining, with continuous cuts.

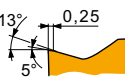
CNMG 120404E-NM	T7325	0.4	130	0.20	2.1	100	0.18	2.1	-	-	-	-	-	45	0.16	1.7	-	-	-	
	T8330	0.4	130	0.20	2.1	100	0.18	2.1	-	-	-	300	0.24	2.1	30	0.16	1.7	-	-	-
	T8430	0.4	130	0.20	2.1	100	0.18	2.1	-	-	-	300	0.24	2.1	30	0.16	1.7	-	-	-

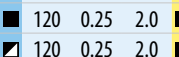
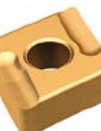
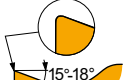

Suitability and starting values for cutting speed (vc), feed (f) and depth of cut (ap). Refer to our Machining Calculator app for further calculations.

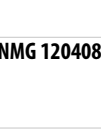
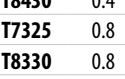
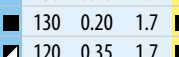
Product	RE [mm]	P			M			K			N			S			H			
		vc [m/min]	f [mm/rev]	ap [mm]	vc [m/min]	f [mm/rev]	ap [mm]	vc [m/min]	f [mm/rev]	ap [mm]	vc [m/min]	f [mm/rev]	ap [mm]	vc [m/min]	f [mm/rev]	ap [mm]	vc [m/min]	f [mm/rev]	ap [mm]	
   NM geometry with highly positive design for fine-finish, medium and rough machining, with continuous cuts.	T7325	0.8	120	0.25	2.1	95	0.23	2.1	-	-	-	-	-	45	0.20	1.7	-	-	-	
	T8330	0.8	120	0.25	2.1	95	0.23	2.1	-	-	-	270	0.30	2.1	34	0.20	1.7	-	-	-
	T8430	0.8	120	0.25	2.1	95	0.23	2.1	-	-	-	270	0.30	2.1	30	0.20	1.7	-	-	-
   NMR geometry with positive design for medium to rough machining, and continuous cuts.	T7325	0.4	120	0.25	2.7	95	0.23	2.7	-	-	-	-	-	38	0.20	2.2	-	-	-	
	T8330	0.4	120	0.25	2.0	80	0.23	2.0	-	-	-	-	-	26	0.20	1.6	-	-	-	
	T8430	0.4	120	0.25	2.7	75	0.23	2.7	-	-	-	-	-	23	0.20	2.2	-	-	-	
   NMR geometry with positive design for medium to rough machining, and continuous cuts.	T7325	0.8	120	0.35	2.7	90	0.32	2.7	-	-	-	-	-	41	0.25	2.2	-	-	-	
	T8330	0.8	120	0.35	2.7	90	0.32	2.7	-	-	-	-	-	26	0.25	2.2	-	-	-	
	T8430	0.8	120	0.35	2.7	80	0.32	2.7	-	-	-	-	-	23	0.25	2.2	-	-	-	
   R geometry for semi-rough to rough machining, and continuous to interrupted cuts.	T5315	0.8	120	0.40	4.0	-	-	-	80	0.40	4.0	-	-	-	-	-	30	0.15	1.0	
	T9325	0.8	120	0.40	4.0	-	-	-	80	0.40	4.0	-	-	-	-	-	-	-	-	
   SF geometry with positive design for fine-finish machining of thin walls and continuous cuts.	H07	0.4	-	-	-	90	0.14	1.0	110	0.15	1.0	330	0.18	1.0	34	0.12	0.8	-	-	
	T6310	0.4	140	0.15	1.0	100	0.14	1.0	110	0.15	1.0	330	0.18	1.0	38	0.12	0.8	26	0.15	1.0
   SF geometry with positive design for fine-finish machining of thin walls and continuous cuts.	H07	0.8	-	-	-	95	0.18	1.0	100	0.20	1.0	300	0.24	1.0	38	0.14	0.8	-	-	
	T6310	0.8	130	0.20	1.0	100	0.18	1.0	100	0.20	1.0	300	0.24	1.0	45	0.14	0.8	30	0.15	1.0
   SM geometry with positive design for medium machining, and continuous to interrupted cuts.	T6310	0.4	130	0.22	2.0	95	0.20	2.0	100	0.22	2.0	300	0.26	2.0	34	0.20	1.6	23	0.15	1.0
	T7325	0.4	130	0.22	2.0	95	0.20	2.0	-	-	-	-	-	41	0.20	1.6	-	-	-	
   SM geometry with positive design for medium machining, and continuous to interrupted cuts.	T6310	0.8	120	0.25	2.0	95	0.23	2.0	95	0.25	2.0	270	0.30	2.0	38	0.20	1.6	26	0.15	1.0
	T7325	0.8	120	0.25	2.0	95	0.23	2.0	-	-	-	-	-	45	0.20	1.6	-	-	-	
   EL-SI geometry with positive left-handed design for fine-finish to semi-rough machining, and continuous cuts.	T7325	0.4	130	0.20	1.7	100	0.18	1.7	-	-	-	-	-	45	0.18	1.4	-	-	-	
	T8330	0.4	130	0.20	1.7	100	0.18	1.7	-	-	-	300	0.24	1.7	34	0.18	1.4	-	-	-
	T8430	0.4	130	0.20	1.7	100	0.18	1.7	-	-	-	300	0.24	1.7	34	0.18	1.4	-	-	-
   EL-SI geometry with positive left-handed design for fine-finish to semi-rough machining, and continuous cuts.	T7325	0.8	120	0.35	1.7	90	0.32	1.7	-	-	-	-	-	45	0.25	1.4	-	-	-	
	T8330	0.8	120	0.35	1.7	90	0.32	1.7	-	-	-	220	0.42	1.7	34	0.25	1.4	-	-	-
	T8430	0.8	120	0.35	1.7	90	0.32	1.7	-	-	-	220	0.42	1.7	30	0.25	1.4	-	-	-



DCMT



	IC	D1	L	S
	[mm]	[mm]	[mm]	[mm]
11T3	9.525	4.40	11.60	3.97
1504	12.700	5.50	15.50	4.76

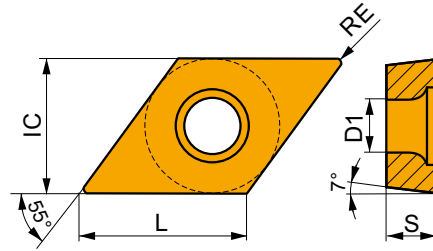

Suitability and starting values for cutting speed (vc), feed (f) and depth of cut (ap). Refer to our Machining Calculator app for further calculations.

Product	RE	P			M			K			N			S			H		
		vc	f	ap	vc	f	ap	vc	f	ap	vc	f	ap	vc	f	ap	vc	f	ap
	[mm]	[m/min]	[mm/rev]	[mm]	[m/min]	[mm/rev]	[mm]	[m/min]	[mm/rev]	[mm]	[m/min]	[mm/rev]	[mm]	[m/min]	[mm/rev]	[mm]	[m/min]	[mm/rev]	[mm]

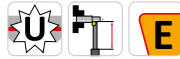
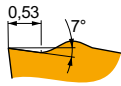

FF2 geometry with positive design for fine-finish to finish machining, and continuous to slightly interrupted cuts.

DCMT 11T308E-FF2	T7325	0.8	130	0.17	0.8	-	-	-	-	-	-	-	-	-	-	-	-	-	-
	T8330	0.8	130	0.17	0.8	-	-	-	105	0.17	0.8	-	-	-	-	-	-	-	-
	T8430	0.8	130	0.17	0.8	-	-	-	105	0.17	0.8	-	-	-	-	-	-	-	-

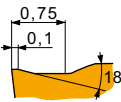

FM2 geometry for finish to medium machining, and continuous to interrupted cuts.

DCMT 150408E-FM2	T9325	0.8	130	0.20	1.5	100	0.18	1.5	100	0.20	1.5	-	-	-	-	-	-	-	-
	T9335	0.8	130	0.20	1.5	95	0.18	1.5	-	-	-	-	-	-	-	-	-	-	-

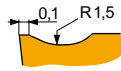

RF geometry for semi-rough to rough machining, and continuous to interrupted cuts.

DCMT 11T308E-RF	T5315	0.8	130	0.20	0.8	-	-	-	100	0.20	0.8	-	-	-	-	-	-	30	0.15	1.0
	T7335	0.8	130	0.20	0.8	100	0.18	0.8	-	-	-	-	-	-	-	-	-	-	-	



DCMW

	IC	D1	L	S
	[mm]	[mm]	[mm]	[mm]
11T3	9.525	4.40	11.60	3.97

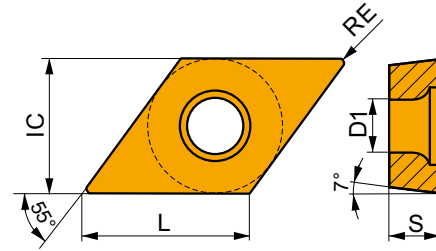

Suitability and starting values for cutting speed (vc), feed (f) and depth of cut (ap). Refer to our Machining Calculator app for further calculations.

Product	RE	P			M			K			N			S			H		
		vc	f	ap	vc	f	ap	vc	f	ap	vc	f	ap	vc	f	ap	vc	f	ap
	[mm]	[m/min]	[mm/rev]	[mm]	[m/min]	[mm/rev]	[mm]	[m/min]	[mm/rev]	[mm]	[m/min]	[mm/rev]	[mm]	[m/min]	[mm/rev]	[mm]	[m/min]	[mm/rev]	[mm]



For fine-finish to semi-rough machining, and continuous to slightly interrupted cuts.

DCMW 11T304	T5315	0.4	–	–	–	–	–	–	–	115	0.10	1.2	–	–	–	–	–	–	–	26	0.15	1.0
	T6310	0.4	–	–	–	–	–	–	–	80	0.10	1.2	–	–	–	–	–	–	–	15	0.15	1.0
DCMW 11T308	T5315	0.8	–	–	–	–	–	–	–	105	0.18	1.2	–	–	–	–	–	–	–	23	0.15	1.0
	T6310	0.8	–	–	–	–	–	–	–	80	0.18	1.2	–	–	–	–	–	–	–	15	0.15	1.0

DCMW PCD

	IC	D1	L	S
	[mm]	[mm]	[mm]	[mm]
11T3	9.525	4.40	11.60	3.97

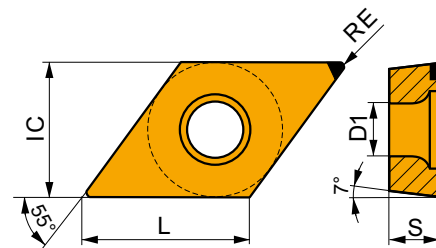

Suitability and starting values for cutting speed (vc), feed (f) and depth of cut (ap). Refer to our Machining Calculator app for further calculations.

Product	RE	P			M			K			N			S			H		
		vc	f	ap	vc	f	ap	vc	f	ap	vc	f	ap	vc	f	ap	vc	f	ap
	[mm]	[m/min]	[mm/rev]	[mm]	[m/min]	[mm/rev]	[mm]	[m/min]	[mm/rev]	[mm]	[m/min]	[mm/rev]	[mm]	[m/min]	[mm/rev]	[mm]	[m/min]	[mm/rev]	[mm]

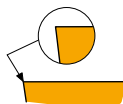

For finish machining, high speeds and stable cutting conditions.

DCMW 11T304FN	PD1	0.4	–	–	–	–	–	–	–	360	0.12	0.5	–	–	–	–	–	–	–	–	–	–
DCMW 11T308FN	PD1	0.8	–	–	–	–	–	–	–	360	0.12	1.0	–	–	–	–	–	–	–	–	–	–



EPGX

	IC	D1	L	S
	[mm]	[mm]	[mm]	[mm]
0502	5.560	2.50	5.70	2.38

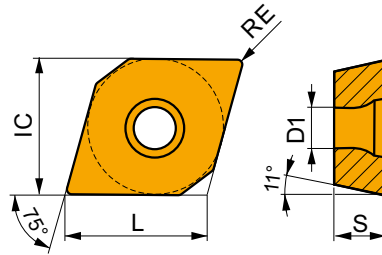

Suitability and starting values for cutting speed (vc), feed (f) and depth of cut (ap). Refer to our Machining Calculator app for further calculations.

Product	RE	P			M			K			N			S			H		
		vc	f	ap	vc	f	ap	vc	f	ap	vc	f	ap	vc	f	ap	vc	f	ap
	[mm]	[m/min]	[mm/rev]	[mm]	[m/min]	[mm/rev]	[mm]	[m/min]	[mm/rev]	[mm]	[m/min]	[mm/rev]	[mm]	[m/min]	[mm/rev]	[mm]	[m/min]	[mm/rev]	[mm]

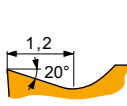

FL-JZ geometry with positive left-handed design for fine-finish machining, and continuous cuts.

EPGX 050202FL-JZ	TT010	0.2	150	0.06	0.5	110	0.05	0.5	-	-	-	-	-	-	-	-	-	-	-
-------------------------	--------------	-----	-----	------	-----	-----	------	-----	---	---	---	---	---	---	---	---	---	---	---

EPMT

	IC	D1	L	S
	[mm]	[mm]	[mm]	[mm]
0502	5.560	2.50	5.70	2.38

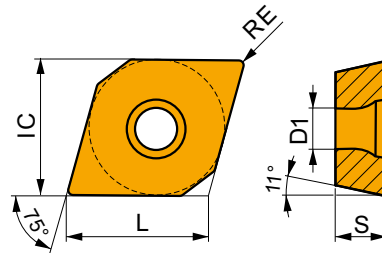

Suitability and starting values for cutting speed (vc), feed (f) and depth of cut (ap). Refer to our Machining Calculator app for further calculations.

Product	RE	P			M			K			N			S			H		
		vc	f	ap	vc	f	ap	vc	f	ap	vc	f	ap	vc	f	ap	vc	f	ap
	[mm]	[m/min]	[mm/rev]	[mm]	[m/min]	[mm/rev]	[mm]	[m/min]	[mm/rev]	[mm]	[m/min]	[mm/rev]	[mm]	[m/min]	[mm/rev]	[mm]	[m/min]	[mm/rev]	[mm]



NF2 geometry with positive design for fine-finish to semi-rough machining, and continuous cuts.

EPMT 050202E-NF2	H07	0.2	-	-	-	80	0.09	0.8	115	0.10	0.8	360	0.12	0.8	30	0.07	0.6	-	-	-
	T7325	0.2	150	0.07	0.8	110	0.06	0.8	-	-	-	-	-	-	45	0.06	0.6	-	-	-
	T7335	0.2	150	0.07	0.8	110	0.06	0.8	-	-	-	-	-	-	45	0.06	0.6	-	-	-
	T9315	0.2	150	0.05	0.8	-	-	-	115	0.05	0.8	-	-	-	-	-	-	-	-	-
	T9325	0.2	150	0.07	0.8	110	0.06	0.8	115	0.07	0.8	-	-	-	45	0.06	0.6	-	-	-
	T9335	0.2	140	0.10	0.8	110	0.09	0.8	-	-	-	-	-	-	34	0.07	0.6	-	-	-
	TT010	0.2	150	0.05	0.5	110	0.05	0.5	-	-	-	-	-	-	-	-	-	-	-	-



TCGT



	IC	D1	L	S
	[mm]	[mm]	[mm]	[mm]
06T1	3.970	2.20	6.90	1.98
0902	5.560	2.50	9.60	2.38
1102-SF3	6.350	2.80	11.00	2.58
16T3	9.525	4.40	16.50	3.97
16T3-SF3	9.525	4.40	16.50	4.22

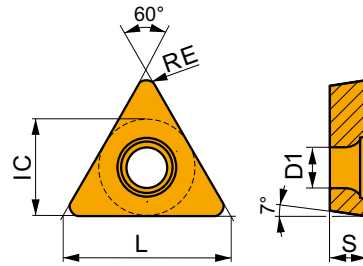

Suitability and starting values for cutting speed (vc), feed (f) and depth of cut (ap). Refer to our Machining Calculator app for further calculations.

Product	RE	P			M			K			N			S			H		
		vc	f	ap	vc	f	ap	vc	f	ap	vc	f	ap	vc	f	ap	vc	f	ap
	[mm]	[m/min]	[mm/rev]	[mm]	[m/min]	[mm/rev]	[mm]	[m/min]	[mm/rev]	[mm]	[m/min]	[mm/rev]	[mm]	[m/min]	[mm/rev]	[mm]	[m/min]	[mm/rev]	[mm]



AL geometry with highly positive design for fine-finish to rough machining, and continuous to slightly interrupted cuts.

TCGT 090202F-AL	HF7	0.2	–	–	–	–	–	–	–	–	–	–	–	–	–	–	–	–	–
	T0315	0.2	–	–	–	–	–	–	–	–	–	–	–	–	–	–	–	–	–
TCGT 090204F-AL	HF7	0.4	–	–	–	–	–	–	–	–	–	–	–	–	–	–	–	–	–
	T0315	0.4	–	–	–	–	–	–	–	–	–	–	–	–	–	–	–	–	–
TCGT 16T304F-AL	HF7	0.4	–	–	–	–	–	–	–	–	–	–	–	–	–	–	–	–	–
	T0315	0.4	–	–	–	–	–	–	–	–	–	–	–	–	–	–	–	–	–
TCGT 16T308F-AL	HF7	0.8	–	–	–	–	–	–	–	–	–	–	–	–	–	–	–	–	–
	T0315	0.8	–	–	–	–	–	–	–	–	–	–	–	–	–	–	–	–	–

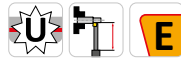
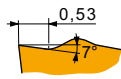

FF2 geometry with positive design for fine-finish to finish machining, and continuous to slightly interrupted cuts.

TCGT 06T102E-FF2	T8330	0.2	■	150	0.05	0.8	–	–	–	■	115	0.05	0.8	–	–	–	–	–	–
	T8430	0.2	■	150	0.05	0.8	–	–	–	■	115	0.05	0.8	–	–	–	–	–	–
	TT010	0.2	■	150	0.05	0.5	–	–	–	–	–	–	–	–	–	–	–	–	–
TCGT 090202E-FF2	TT010	0.2	■	150	0.05	0.5	–	–	–	–	–	–	–	–	–	–	–	–	–

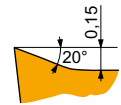

SF3 geometry with highly positive design for fine to finish machining, and continuous cuts.

TCGT 110204E-SF3	H07	0.4	–	–	–	■	80	0.09	0.8	■	115	0.10	0.8	■	360	0.12	0.8	■	30	0.07	0.6	–	–	–	
	T6310	0.4	■	140	0.10	0.8	■	110	0.09	0.8	■	115	0.10	0.8	■	360	0.12	0.8	■	34	0.07	0.6	■	23	0.15
TCGT 16T308E-SF3	H07	0.8	–	–	–	■	90	0.09	1.2	■	115	0.10	1.2	■	360	0.12	1.2	■	34	0.08	1.0	–	–	–	
	T6310	0.8	■	140	0.10	1.2	■	110	0.09	1.2	■	115	0.10	1.2	■	360	0.12	1.2	■	38	0.08	1.0	■	26	0.15



TCMT



	IC	D1	L	S
	[mm]	[mm]	[mm]	[mm]
06T1	3.970	2.20	6.90	1.98
0902	5.560	2.50	9.60	2.38
16T3	9.525	4.40	16.50	3.97

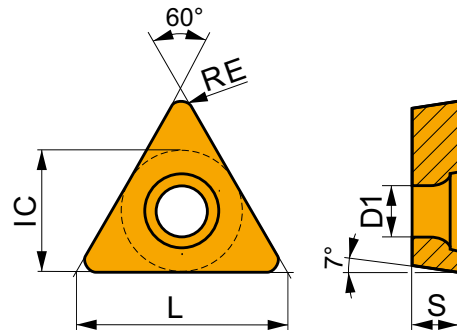

Suitability and starting values for cutting speed (vc), feed (f) and depth of cut (ap). Refer to our Machining Calculator app for further calculations.

Product	RE	P			M			K			N			S			H		
		vc	f	ap	vc	f	ap	vc	f	ap	vc	f	ap	vc	f	ap	vc	f	ap
	[mm]	[m/min]	[mm/rev]	[mm]	[m/min]	[mm/rev]	[mm]	[m/min]	[mm/rev]	[mm]	[m/min]	[mm/rev]	[mm]	[m/min]	[mm/rev]	[mm]	[m/min]	[mm/rev]	[mm]

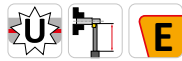
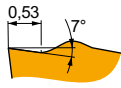

FF2 geometry with positive design for fine-finish to finish machining, and continuous to slightly interrupted cuts.

TCMT 06T102E-FF2	T8330	0.2	█	150	0.05	0.8	█	–	–	–	█	115	0.05	0.8	–	–	–	–	–	–
	T8430	0.2	█	150	0.05	0.8	█	–	–	–	█	115	0.05	0.8	–	–	–	–	–	–
	T9315	0.2	█	150	0.05	0.8	█	–	–	–	█	115	0.05	0.8	–	–	–	–	–	–
TCMT 06T104E-FF2	T8330	0.4	█	140	0.12	0.8	█	–	–	–	█	110	0.12	0.8	–	–	–	–	–	–
	T8430	0.4	█	140	0.12	0.8	█	–	–	–	█	110	0.12	0.8	–	–	–	–	–	–
	T9325	0.4	█	140	0.12	0.8	█	–	–	–	█	110	0.12	0.8	–	–	–	–	–	–
TCMT 090204E-FF2	T8330	0.4	█	140	0.12	1.0	█	–	–	–	█	110	0.12	1.0	–	–	–	–	–	–
	T8430	0.4	█	140	0.12	1.0	█	–	–	–	█	110	0.12	1.0	–	–	–	–	–	–
	T9325	0.4	█	140	0.12	1.0	█	–	–	–	█	110	0.12	1.0	–	–	–	–	–	–
TCMT 16T304E-FF2	T8330	0.4	█	140	0.12	0.8	█	–	–	–	█	110	0.12	0.8	–	–	–	–	–	–
	T8430	0.4	█	140	0.12	0.8	█	–	–	–	█	110	0.12	0.8	–	–	–	–	–	–
	T9325	0.4	█	140	0.12	0.8	█	–	–	–	█	110	0.12	0.8	–	–	–	–	–	–
TCMT 16T308E-FF2	TT010	0.4	█	150	0.06	0.5	█	–	–	–	–	–	–	–	–	–	–	–	–	–
	T8330	0.8	█	130	0.17	0.8	█	–	–	–	█	105	0.17	0.8	–	–	–	–	–	–
	T8430	0.8	█	130	0.17	0.8	█	–	–	–	█	105	0.17	0.8	–	–	–	–	–	–
T9325	0.8	█	130	0.17	0.8	█	–	–	–	█	105	0.17	0.8	–	–	–	–	–	–	–

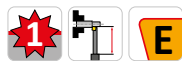

FM geometry for finish to semi-rough machining, and continuous to slightly interrupted cuts.

TCMT 16T304E-FM	T7325	0.4	█	130	0.19	1.7	█	100	0.17	1.7	–	–	–	–	–	–	–	–	–	–	
	T8330	0.4	█	140	0.12	1.7	█	90	0.11	1.7	█	110	0.12	1.7	█	360	0.14	1.7	–	–	–
	T8430	0.4	█	140	0.12	1.7	█	90	0.11	1.7	█	110	0.12	1.7	█	360	0.14	1.7	–	–	–

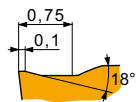

FM2 geometry for finish to medium machining, and continuous to interrupted cuts.

TCMT 16T308E-FM2	T8330	0.8	█	130	0.20	1.0	█	85	0.18	1.0	█	100	0.20	1.0	–	–	–	–	–	–
	T8430	0.8	█	130	0.20	1.0	█	85	0.18	1.0	█	100	0.20	1.0	–	–	–	–	–	–
	T9325	0.8	█	130	0.20	1.0	█	100	0.18	1.0	█	100	0.20	1.0	–	–	–	–	–	–

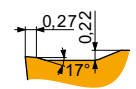

RM geometry for semi-rough machining, and continuous to interrupted cuts.

TCMT 16T308E-RM	T5315	0.8	█	120	0.27	1.9	█	–	–	–	█	95	0.27	1.9	–	–	–	–	–	–	
	T8330	0.8	█	120	0.27	1.9	█	85	0.24	1.9	█	95	0.27	1.9	–	–	–	█	26	0.19	1.5
	T8430	0.8	█	120	0.27	1.9	█	85	0.24	1.9	█	95	0.27	1.9	–	–	–	█	23	0.19	1.5



Suitability and starting values for cutting speed (vc), feed (f) and depth of cut (ap). Refer to our Machining Calculator app for further calculations.

Product	RE [mm]	P			M			K			N			S			H		
		vc [m/min]	f [mm/rev]	ap [mm]	vc [m/min]	f [mm/rev]	ap [mm]	vc [m/min]	f [mm/rev]	ap [mm]	vc [m/min]	f [mm/rev]	ap [mm]	vc [m/min]	f [mm/rev]	ap [mm]	vc [m/min]	f [mm/rev]	ap [mm]

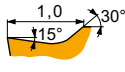
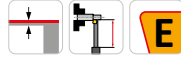

UR geometry for fine to finish machining, and continuous to slightly interrupted cuts.

TCMT 16T304E-UR	T8330	0.4	135	0.12	0.8	80	0.11	0.8	110	0.12	0.8	-	-	-	-	-	-	-
	T8430	0.4	140	0.12	0.8	85	0.11	0.8	110	0.12	0.8	-	-	-	-	-	-	-
	T9325	0.4	130	0.18	0.8	100	0.16	0.8	105	0.18	0.8	-	-	-	-	-	-	-
TCMT 16T308E-UR	TT310	0.4	140	0.12	0.8	110	0.11	0.8	-	-	-	-	-	-	-	-	-	-
	T8330	0.8	130	0.17	0.8	90	0.15	0.8	105	0.17	0.8	-	-	-	-	-	-	-
	T8430	0.8	130	0.17	0.8	90	0.15	0.8	105	0.17	0.8	-	-	-	-	-	-	-
	T9325	0.8	130	0.17	0.8	100	0.15	0.8	105	0.17	0.8	-	-	-	-	-	-	-

TCMW



	IC [mm]	D1 [mm]	L [mm]	S [mm]
16T3	9.525	4.40	16.50	3.97

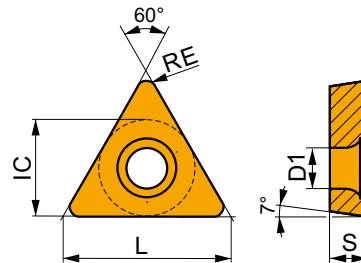

Suitability and starting values for cutting speed (vc), feed (f) and depth of cut (ap). Refer to our Machining Calculator app for further calculations.

Product	RE [mm]	P			M			K			N			S			H		
		vc [m/min]	f [mm/rev]	ap [mm]	vc [m/min]	f [mm/rev]	ap [mm]	vc [m/min]	f [mm/rev]	ap [mm]	vc [m/min]	f [mm/rev]	ap [mm]	vc [m/min]	f [mm/rev]	ap [mm]	vc [m/min]	f [mm/rev]	ap [mm]

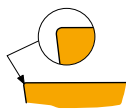

For fine-finish to semi-rough machining, and continuous to slightly interrupted cuts.

TCMW 16T304	T5305	0.4	-	-	-	-	-	-	115	0.10	1.5	-	-	-	-	-	-	30	0.15	1.0
	T5315	0.4	-	-	-	-	-	-	115	0.10	1.5	-	-	-	-	-	-	26	0.15	1.0
	T6310	0.4	-	-	-	-	-	-	85	0.10	1.5	-	-	-	-	-	-	15	0.15	1.0
TCMW 16T308	T5305	0.8	-	-	-	-	-	-	105	0.18	1.5	-	-	-	-	-	-	30	0.15	1.0
	T5315	0.8	-	-	-	-	-	-	105	0.18	1.5	-	-	-	-	-	-	26	0.15	1.0
	T6310	0.8	-	-	-	-	-	-	85	0.18	1.5	-	-	-	-	-	-	15	0.15	1.0



BORING ARBORS



ARBORS - DESCRIPTION

1	2	3	4	5
AS 3	30	022	100	R

1		2	3	4		5	
Arbor type		Cone	Size	Length LU		Variant	
AS 3	DIN 69871	30	022	055	55 mm	R	Internal coolant
BT 3	MAS BT	40	027	100	100 mm		
HSK	HSK	63A	032				
OTT 3	DIN 2080	50	042				
3	MORSE	05	054				
B	WELDON	25	068				
P	EXTENSION		085				
R	REDUCTION		100				
ADT	ADAPTOR		200				
			300				
			400				
			500				



69871-BS





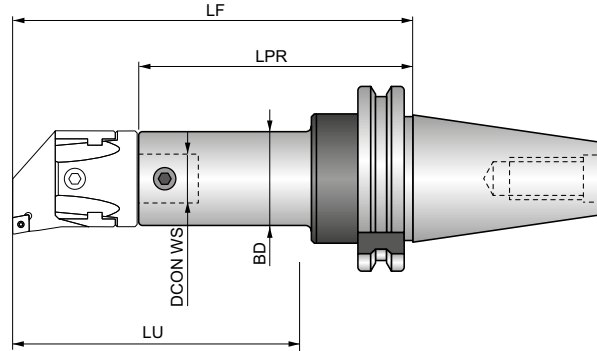

DIN 69871 Shank Tool Holder for Boring Heads

DIN 69871 highly rigid tool holder (for ATC) for boring heads, available in 30, 40 and 50 tapers. Different length arbors available. Coupling sizes 22-160 mm can be used with EXT-BS extenders, RED-BS reducers and LA-BS enlargers. Internal coolant available. For applications requiring high accuracy and repeatability.



Product		CZC MS	BD	DCON WS	LF	LPR	LU			
AS 330 022 100 R	30	22	22.00	12.00	138.00	104	100.00	✓	US 0608	0.72
AS 330 027 055 R	30	27	27.00	15.00	90.00	48	55.00	✓	US 0609	0.56
AS 330 027 100 R	30	27	27.00	15.00	138.00	96	100.00	✓	US 0609	0.68
AS 330 032 060 R	30	32	32.00	20.00	96.00	51	60.00	✓	US 0810	0.51
AS 330 032 100 R	30	32	32.00	20.00	138.00	93	100.00	✓	US 0810	0.74
AS 340 022 080 R	40	22	22.00	12.00	118.00	84	80.00	✓	US 0608	1.14
AS 340 022 100 R	40	22	22.00	12.00	138.00	104	100.00	✓	US 0608	1.24
AS 340 027 055 R	40	27	27.00	15.00	90.00	48	55.00	✓	US 0609	1.05
AS 340 027 100 R	40	27	27.00	15.00	138.00	96	100.00	✓	US 0609	1.30
AS 340 027 130 R	40	27	27.00	15.00	168.00	126	130.00	✓	US 0609	1.43
AS 340 032 060 R	40	32	32.00	20.00	96.00	51	60.00	✓	US 0810	1.10
AS 340 032 100 R	40	32	32.00	20.00	138.00	93	100.00	✓	US 0810	1.35
AS 340 032 130 R	40	32	32.00	20.00	168.00	123	130.00	✓	US 0810	1.52
AS 340 042 075 R	40	42	42.00	24.00	112.00	56	75.00	✓	US 1014	1.16
AS 340 042 160 R	40	42	42.00	24.00	182.00	126	160.00	✓	US 1014	1.90
AS 340 042 200 R	40	42	42.00	24.00	222.00	166	200.00	✓	US 1014	2.37
AS 340 054 120 R	40	54	54.00	28.00	142.00	76	120.00	✓	US 1219	1.58
AS 340 054 160 R	40	54	54.00	28.00	182.00	116	160.00	✓	US 1219	2.28
AS 340 054 200 R	40	54	54.00	28.00	222.00	156	200.00	✓	US 1219	2.93
AS 340 068 160 R	40	68	68.00	36.00	183.00	97	160.00	✓	US 1625	2.36
AS 340 068 200 R	40	68	68.00	36.00	223.00	137	200.00	✓	US 1625	3.50
AS 340 085 200 R	40	85	85.00	50.00	224.00	124	200.00	✓	US 1630	3.96
AS 340 100 200 R	40	100, 200	100.00	60.00	224.00	124	200.00	✓	US 2032	5.21
AS 350 022 080 R	50	22	22.00	12.00	118.00	84	80.00	✓	US 0608	3.43
AS 350 022 100 R	50	22	22.00	12.00	138.00	104	100.00	✓	US 0608	3.40
AS 350 027 055 R	50	27	27.00	15.00	90.00	48	55.00	✓	US 0609	3.30
AS 350 027 100 R	50	27	27.00	15.00	138.00	96	100.00	✓	US 0609	3.48
AS 350 027 130 R	50	27	27.00	15.00	168.00	126	130.00	✓	US 0609	3.48
AS 350 032 060 R	50	32	32.00	20.00	96.00	51	60.00	✓	US 0810	2.98
AS 350 032 130 R	50	32	32.00	20.00	168.00	123	130.00	✓	US 0810	3.71
AS 350 032 160 R	50	32	32.00	20.00	198.00	153	160.00	✓	US 0810	3.95
AS 350 042 075 R	50	42	42.00	24.00	112.00	56	75.00	✓	US 1014	3.32
AS 350 042 160 R	50	42	42.00	24.00	198.00	142	160.00	✓	US 1014	4.26
AS 350 042 200 R	50	42	42.00	24.00	238.00	182	200.00	✓	US 1014	4.74



Product		CZC MS	BD	DCON WS	LF	LPR	LU			
			[mm]	[mm]	[mm]	[mm]	[mm]			
AS 350 054 090 R	50	54	54.00	28.00	128.00	62	90.00	✓	US 1219	3.39
AS 350 054 160 R	50	54	54.00	28.00	198.00	132	160.00	✓	US 1219	4.74
AS 350 054 200 R	50	54	54.00	28.00	238.00	172	200.00	✓	US 1219	5.48
AS 350 068 115 R	50	68	68.00	36.00	151.00	65	115.00	✓	US 1625	3.66
AS 350 068 200 R	50	68	68.00	36.00	223.00	137	200.00	✓	US 1625	5.81
AS 350 068 260 R	50	68	68.00	36.00	283.00	197	260.00	✓	US 1625	7.48
AS 350 085 200 R	50	85	85.00	50.00	224.00	124	200.00	✓	US 1630	6.21
AS 350 085 260 R	50	85	85.00	50.00	284.00	184	260.00	✓	US 1630	8.91
AS 350 085 320 R	50	85	85.00	50.00	344.00	244	320.00	✓	US 1630	11.50
AS 350 100 190 R	50	100, 200	100.00	60.00	214.00	114	190.00	✓	US 2032	6.52
AS 350 100 260 R	50	100, 200	100.00	60.00	284.00	184	260.00	✓	US 2032	10.85
AS 350 100 320 R	50	100, 200	100.00	60.00	344.00	244	320.00	✓	US 2032	14.47
AS 550 160	50	300, 400, 500	100.00	60.00	160.00	70	125.00	–	US 1240	5.55



BT-BS





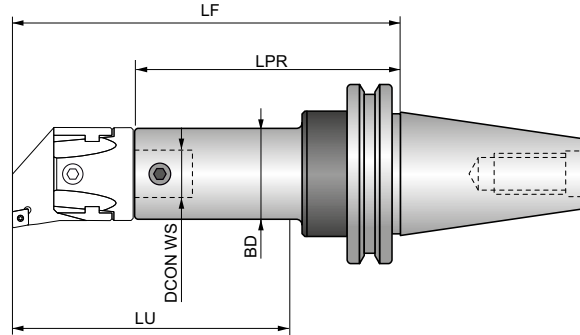

MAS 403-BT Shank Tool Holder for Boring Heads

MAS 403-BT highly rigid tool holder (for ATC) for boring heads, available in 30, 40 and 50 tapers. Different length arbors available. Coupling sizes 22-160 mm can be used with EXT-BS extenders, RED-BS reducers and LA-BS enlargers. Internal coolant available. For applications requiring high accuracy and repeatability.



Product		CZC MS	BD	DCON WS	LF	LPR	LU			
BT 330 022 100 R	30	22	22.00	12.00	125.00	91	100.00	✓	US 0608	0.56
BT 330 027 055 R	30	27	27.00	15.00	77.00	35	55.00	✓	US 0609	0.41
BT 330 027 100 R	30	27	27.00	15.00	125.00	83	100.00	✓	US 0609	0.69
BT 330 032 060 R	30	32	32.00	20.00	83.00	38	60.00	✓	US 0810	0.47
BT 330 032 100 R	30	32	32.00	20.00	125.00	80	100.00	✓	US 0810	0.70
BT 330 042 075 R	30	42	42.00	24.00	100.00	44	75.00	✓	US 1014	0.56
BT 340 022 050 R	40	22	22.00	12.00	80.00	46	50.00	✓	US 0608	1.02
BT 340 022 080 R	40	22	22.00	12.00	110.00	76	80.00	✓	US 0608	1.16
BT 340 022 100 R	40	22	22.00	12.00	130.00	96	100.00	✓	US 0608	1.14
BT 340 027 055 R	40	27	27.00	15.00	82.00	40	55.00	✓	US 0609	1.06
BT 340 027 100 R	40	27	27.00	15.00	130.00	88	100.00	✓	US 0609	1.26
BT 340 027 130 R	40	27	27.00	15.00	160.00	118	130.00	✓	US 0609	1.39
BT 340 032 060 R	40	32	32.00	20.00	88.00	43	60.00	✓	US 0810	1.00
BT 340 032 100 R	40	32	32.00	20.00	130.00	85	100.00	✓	US 0810	1.31
BT 340 032 130 R	40	32	32.00	20.00	160.00	115	130.00	✓	US 0810	1.50
BT 340 042 075 R	40	42	42.00	24.00	104.00	48	75.00	✓	US 1014	1.14
BT 340 042 160 R	40	42	42.00	24.00	190.00	134	160.00	✓	US 1014	2.05
BT 340 042 200 R	40	42	42.00	24.00	230.00	174	200.00	✓	US 1014	2.39
BT 340 054 090 R	40	54	54.00	28.00	120.00	54	90.00	✓	US 1219	1.13
BT 340 054 160 R	40	54	54.00	28.00	190.00	124	160.00	✓	US 1219	2.55
BT 340 054 200 R	40	54	54.00	28.00	230.00	164	200.00	✓	US 1219	3.10
BT 340 068 160 R	40	68	68.00	36.00	181.00	95	160.00	✓	US 1625	2.46
BT 340 068 200 R	40	68	68.00	36.00	221.00	135	200.00	✓	US 1625	3.64
BT 340 085 200 R	40	85	85.00	50.00	220.00	120	200.00	✓	US 1630	4.04
BT 340 100 200 R	40	100	100.00	60.00	220.00	120	200.00	✓	US 2032	4.95
BT 350 022 080 R	50	22	22.00	12.00	121.00	87	80.00	✓	US 0608	3.95
BT 350 022 100 R	50	22	22.00	12.00	141.00	107	100.00	✓	US 0608	3.50
BT 350 027 055 R	50	27	27.00	15.00	93.00	51	55.00	✓	US 0609	3.68
BT 350 027 100 R	50	27	27.00	15.00	141.00	99	100.00	✓	US 0609	4.00
BT 350 027 130 R	50	27	27.00	15.00	171.00	129	130.00	✓	US 0609	4.14
BT 350 032 060 R	50	32	32.00	20.00	99.00	54	60.00	✓	US 0810	3.67
BT 350 032 130 R	50	32	32.00	20.00	171.00	126	130.00	✓	US 0810	4.24
BT 350 032 160 R	50	32	32.00	20.00	201.00	156	160.00	✓	US 0810	4.56
BT 350 042 075 R	50	42	42.00	24.00	115.00	59	75.00	✓	US 1014	3.84



Product		CZC MS	BD	DCON WS	LF	LPR	LU			
			[mm]	[mm]	[mm]	[mm]	[mm]			
BT 350 042 160 R	50	42	42.00	24.00	201.00	145	160.00	✓	US 1014	4.89
BT 350 042 200 R	50	42	42.00	24.00	241.00	185	200.00	✓	US 1014	5.25
BT 350 054 090 R	50	54	54.00	28.00	131.00	65	90.00	✓	US 1219	3.90
BT 350 054 160 R	50	54	54.00	28.00	201.00	135	160.00	✓	US 1219	5.39
BT 350 054 200 R	50	54	54.00	28.00	241.00	175	200.00	✓	US 1219	5.98
BT 350 068 115 R	50	68	68.00	36.00	154.00	68	115.00	✓	US 1625	4.09
BT 350 068 200 R	50	68	68.00	36.00	242.00	156	200.00	✓	US 1625	6.66
BT 350 068 260 R	50	68	68.00	36.00	302.00	216	260.00	✓	US 1625	8.18
BT 350 085 200 R	50	85	85.00	50.00	242.00	142	200.00	✓	US 1630	7.40
BT 350 085 260 R	50	85	85.00	50.00	302.00	202	260.00	✓	US 1630	9.89
BT 350 085 320 R	50	85	85.00	50.00	362.00	262	320.00	✓	US 1630	12.76
BT 350 100 170 R	50	100, 200	100.00	60.00	195.00	95	170.00	✓	US 2032	5.71
BT 350 100 260 R	50	100, 200	100.00	60.00	302.00	202	260.00	✓	US 2032	12.34
BT 350 100 320 R	50	100, 200	100.00	60.00	362.00	262	320.00	✓	US 2032	14.50
BT 550 160	50	300, 400, 500	100.00	60.00	160.00	70	125.00	–	US 1240	6.05



HSK-BS



HSK Shank Tool Holder for Boring Heads

HSK highly rigid tool holder (for ATC) for boring heads, available in 50A, 63A or 100A taper. Coupling sizes 22 up to 160 mm can be used in combination with EXT-BS extenders, RED-BS reducers and LA-BS enlargers. Internal coolant available. For applications requiring high accuracy and repeatability.

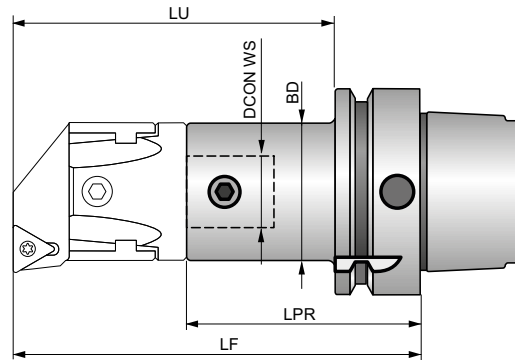

Product		CZC MS	BD	DCON WS	LF	LPR	LU			
HSK 050A 022 055	50	22	22.00	12.00	81.00	47	55.00	–	US 0608	0.49
HSK 050A 027 065	50	27	27.00	15.00	91.00	49	65.00	–	US 0609	0.49
HSK 050A 032 075	50	32	32.00	20.00	101.00	56	75.00	–	US 0810	0.66
HSK 050A 042 090	50	42	42.00	24.00	116.00	60	90.00	–	US 1014	0.71
HSK 063A 022 055	63	22	22.00	12.00	81.00	47	55.00	–	US 0608	0.07
HSK 063A 027 065	63	27	27.00	15.00	91.00	49	65.00	–	US 0609	0.76
HSK 063A 032 075	63	32	32.00	20.00	101.00	56	75.00	–	US 0810	0.82
HSK 063A 042 090	63	42	42.00	24.00	116.00	60	90.00	–	US 1014	0.96
HSK 063A 054 110	63	54	54.00	28.00	136.00	70	110.00	–	US 1219	1.26
HSK 063A 068 145	63	68	68.00	36.00	171.00	85	145.00	–	US 1625	1.81
HSK 100A 022 055	100	22	22.00	12.00	89.00	55	55.00	–	US 0608	2.28
HSK 100A 027 065	100	27	27.00	15.00	99.00	57	65.00	–	US 0609	2.34
HSK 100A 032 075	100	32	32.00	20.00	104.00	59	75.00	–	US 0810	2.73
HSK 100A 042 090	100	42	42.00	24.00	119.00	63	90.00	–	US 1014	2.45
HSK 100A 054 110	100	54	54.00	28.00	139.00	73	110.00	–	US 1219	2.79
HSK 100A 068 145	100	68	68.00	36.00	174.00	88	145.00	–	US 1625	3.52
HSK 100A 085 165	100	85	85.00	50.00	194.00	94	165.00	–	US 1630	4.15
HSK 100A 100 185	100	100, 200	100.00	60.00	214.00	114	185.00	–	US 2032	5.63
HSK 550 160	100	300, 400, 500	100.00	60.00	170.00	80	140.00	–	US 1240	5.24



2080-BS





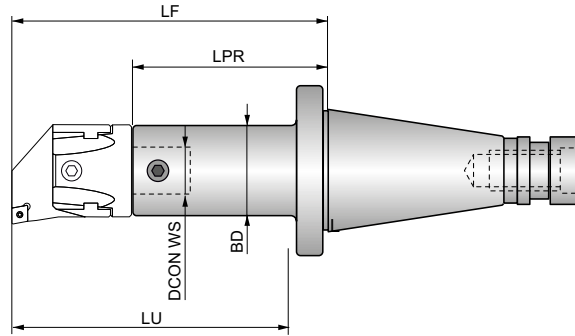

DIN 2080 Shank Tool Holder for Boring Heads

DIN 2080 highly rigid tool holder (for MTC) for boring heads in 40 and 50 taper. Different length arbors available. Coupling sizes 22 - 160 mm can be used in combination with EXT-BS extenders, RED-BS reducers and LA-BS enlargers. Internal coolant available. For applications requiring high accuracy and repeatability.



Product		CZC MS	BD	DCON WS	LF	LPR	LU			
			[mm]	[mm]	[mm]	[mm]	[mm]			
OTT 340 022 080 R	40	22	22.00	12.00	95.00	61	80.00	✓	US 0608	0.88
OTT 340 022 100 R	40	22	22.00	12.00	115.00	81	100.00	✓	US 0608	0.94
OTT 340 027 055 R	40	27	27.00	15.00	67.00	25	55.00	✓	US 0609	0.86
OTT 340 027 100 R	40	27	27.00	15.00	115.00	73	100.00	✓	US 0609	1.00
OTT 340 027 130 R	40	27	27.00	15.00	145.00	103	130.00	✓	US 0609	1.12
OTT 340 032 060 R	40	32	32.00	20.00	73.00	28	60.00	✓	US 0810	0.90
OTT 340 032 100 R	40	32	32.00	20.00	115.00	70	100.00	✓	US 0810	1.10
OTT 340 032 130 R	40	32	32.00	20.00	145.00	100	130.00	✓	US 0810	1.22
OTT 340 042 075 R	40	42	42.00	24.00	89.00	33	75.00	✓	US 1014	0.89
OTT 340 042 160 R	40	42	42.00	24.00	175.00	119	160.00	✓	US 1014	1.73
OTT 340 042 200 R	40	42	42.00	24.00	215.00	159	200.00	✓	US 1014	2.30
OTT 340 054 090 R	40	54	54.00	28.00	105.00	39	90.00	✓	US 1219	1.08
OTT 340 054 160 R	40	54	54.00	28.00	175.00	109	160.00	✓	US 1219	2.23
OTT 340 054 200 R	40	54	54.00	28.00	215.00	149	200.00	✓	US 1219	3.06
OTT 340 068 160 R	40	68	68.00	36.00	175.00	90	160.00	✓	US 1625	2.40
OTT 340 068 200 R	40	68	68.00	36.00	216.00	130	200.00	✓	US 1625	3.73
OTT 340 085 200 R	40	85	85.00	50.00	211.00	111	200.00	✓	US 1630	4.03
OTT 340 100 200 R	40	100, 200	100.00	60.00	211.00	111	200.00	✓	US 2032	5.05
OTT 350 022 080 R	50	22	22.00	12.00	99.00	65	80.00	✓	US 0608	2.98
OTT 350 022 100 R	50	22	22.00	12.00	119.00	85	100.00	✓	US 0608	2.97
OTT 350 027 055 R	50	27	27.00	15.00	71.00	29	55.00	✓	US 0609	2.93
OTT 350 027 100 R	50	27	27.00	15.00	119.00	77	100.00	✓	US 0609	3.01
OTT 350 027 130 R	50	27	27.00	15.00	149.00	107	130.00	✓	US 0609	3.10
OTT 350 032 060 R	50	32	32.00	20.00	77.00	32	60.00	✓	US 0810	2.81
OTT 350 032 130 R	50	32	32.00	20.00	149.00	104	130.00	✓	US 0810	3.24
OTT 350 032 160 R	50	32	32.00	20.00	179.00	134	160.00	✓	US 0810	3.26
OTT 350 042 075 R	50	42	42.00	24.00	93.00	37	75.00	✓	US 1014	2.74
OTT 350 042 160 R	50	42	42.00	24.00	179.00	123	160.00	✓	US 1014	3.64
OTT 350 042 200 R	50	42	42.00	24.00	219.00	163	200.00	✓	US 1014	4.05
OTT 350 054 090 R	50	54	54.00	28.00	109.00	43	90.00	✓	US 1219	3.02
OTT 350 054 160 R	50	54	54.00	28.00	179.00	113	160.00	✓	US 1219	4.15
OTT 350 054 200 R	50	54	54.00	28.00	219.00	153	200.00	✓	US 1219	5.08
OTT 350 068 115 R	50	68	68.00	36.00	132.00	46	115.00	✓	US 1625	3.20
OTT 350 068 200 R	50	68	68.00	36.00	220.00	134	200.00	✓	US 1625	5.54



Product		CZC MS	BD	DCON WS	LF	LPR	LU			
			[mm]	[mm]	[mm]	[mm]	[mm]			
OTT 350 068 260 R	50	68	68.00	36.00	280.00	194	260.00	✓	US 1625	7.22
OTT 350 085 200 R	50	85	85.00	50.00	221.00	121	200.00	✓	US 1630	6.21
OTT 350 085 260 R	50	85	85.00	50.00	281.00	181	260.00	✓	US 1630	9.07
OTT 350 085 320 R	50	85	85.00	50.00	341.00	241	320.00	✓	US 1630	11.84
OTT 350 100 170 R	50	100, 200	100.00	60.00	193.00	93	170.00	✓	US 2032	5.60
OTT 350 100 260 R	50	100, 200	100.00	60.00	281.00	181	260.00	✓	US 2032	10.78
OTT 350 100 320 R	50	100, 200	100.00	60.00	341.00	241	320.00	✓	US 2032	15.10
OTT 550 160	50	300, 400, 500	100.00	60.00	160.00	70	125.00	–	US 1240	5.90



MOR-BS



Morse Taper Shank Tool Holder for Boring Heads

5 Morse Taper highly rigid tool holder for boring heads. Different length arbors available. Coupling sizes 22 up to 160 mm can be used in combination with EXT-BS extenders, RED-BS reducers and LA-BS coupling enlargers. Internal coolant available. For applications requiring high accuracy and repeatability.

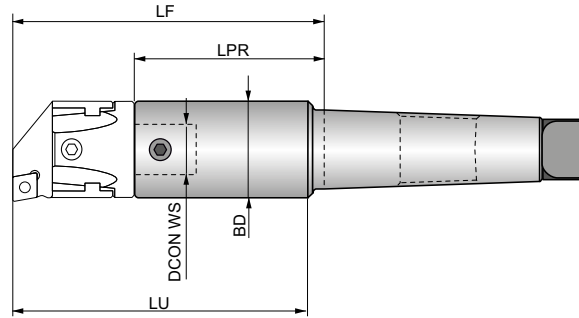

Product	CCTMS	CZC MS	BD	DCON WS	LF	LPR	LU			
			[mm]	[mm]	[mm]	[mm]	[mm]			
305 022 100	5	22	22.00	12.00	112.00	78	100.00	–	US 0608	1.64
305 022 130	5	22	22.00	12.00	142.00	108	130.00	–	US 0608	1.76
305 027 055	5	27	27.00	15.00	65.00	23	55.00	–	US 0609	1.58
305 027 100	5	27	27.00	15.00	113.00	71	100.00	–	US 0609	1.69
305 027 130	5	27	27.00	15.00	143.00	101	130.00	–	US 0609	1.84
305 032 060	5	32	32.00	20.00	70.00	25	60.00	–	US 0810	1.54
305 032 130	5	32	32.00	20.00	143.00	98	130.00	–	US 0810	1.95
305 032 160	5	32	32.00	20.00	173.00	128	160.00	–	US 0810	2.13
305 042 075	5	42	42.00	24.00	83.00	27	75.00	–	US 1014	1.50
305 042 130	5	42	42.00	24.00	188.00	86	130.00	–	US 1014	2.18
305 042 160	5	42	42.00	24.00	218.00	116	160.00	–	US 1014	2.51
305 054 160	5	54	54.00	28.00	172.00	106	160.00	–	US 1219	3.00
305 054 200	5	54	54.00	28.00	212.00	146	200.00	–	US 1219	3.63
305 068 140	5	68	68.00	36.00	146.00	60	140.00	–	US 1625	2.53
305 068 200	5	68	68.00	36.00	212.00	126	200.00	–	US 1625	4.47
305 068 260	5	68	68.00	36.00	272.00	186	260.00	–	US 1625	6.20
305 085 200	5	85	85.00	50.00	216.00	116	200.00	–	US 1630	5.40
305 085 260	5	85	85.00	50.00	276.00	176	260.00	–	US 1630	8.45
305 085 320	5	85	85.00	50.00	336.00	236	320.00	–	US 1630	0.01
305 100 260	5	100, 200	100.00	60.00	276.00	176	260.00	–	US 2032	7.95
305 100 320	5	100, 200	100.00	60.00	336.00	236	320.00	–	US 2032	11.39
505 160	5	300, 400, 500	100.00	60.00	146.00	56	140.00	–	US 2032	4.70



WEL-BS



WELDON Shank Tool Holder for Boring Heads

Weldon highly rigid tool holders for boring heads, shank diameters from 20 up to 40 mm. Different length arbors available. Coupling sizes 22 up to 42 mm can be used in combination with EXT-BS extenders and RED-BS reducers. Internal coolant available. For applications requiring high accuracy and repeatability.

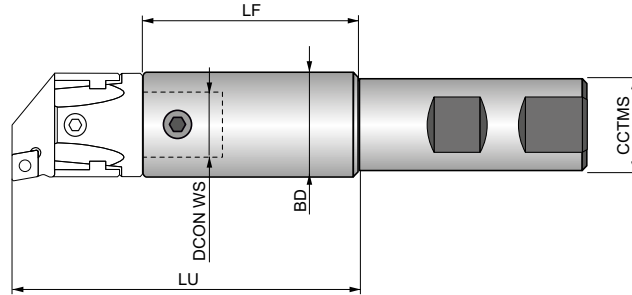

Product	CCTMS	CZC MS	BD	DCON WS	LU			
			[mm]	[mm]	[mm]			
B 020 022 050	20	22	22.00	12.00	50.00	–	US 0608	0.17
B 020 022 100	20	22	22.00	12.00	100.00	–	US 0608	0.34
B 025 027 055	25	27	27.00	15.00	55.00	–	US 0609	0.17
B 025 027 100	25	27	27.00	15.00	95.00	–	US 0609	0.46
B 032 032 060	32	32	32.00	20.00	60.00	–	US 0810	0.43
B 032 032 100	32	32	32.00	20.00	100.00	–	US 0810	0.69
B 032 032 160	32	32	32.00	20.00	160.00	–	US 0810	1.11
B 032 042 090	32	32	32.00	24.00	90.00	–	US 0810	0.71
B 040 042 090	40	42	42.00	24.00	90.00	–	US 1014	0.98
B 040 042 160	40	42	42.00	24.00	160.00	–	US 1014	1.79



EXT-BS



EXT-BS Boring Head Extension Arbor

Boring head extension adaptor. Coupling sizes from 22 up to 200 mm and different lengths available. Internal and external coolant options available. Suited for all applications requiring high accuracy and repeatability.

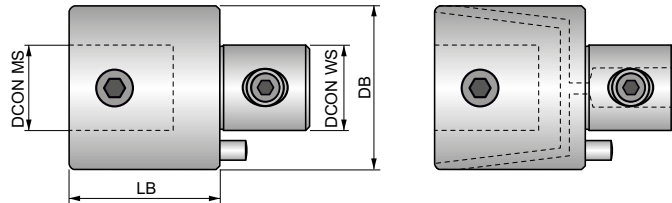

Product	CZC MS	BD	DCON MS	DCON WS	LB			
		[mm]	[mm]	[mm]	[mm]			
P 022 030 R	22	22.00	12.00	12.00	30.00	✓	US 0608	0.09
P 027 030 R	27	27.00	15.00	15.00	30.00	✓	US 0609	0.13
P 032 035 R	32	32.00	20.00	20.00	35.00	✓	US 0810	0.20
P 042 040 R	42	42.00	24.00	24.00	40.00	✓	US 1014	0.40
P 054 050 R	54	54.00	28.00	28.00	50.00	✓	US 1219	0.85
P 068 060 R	68	68.00	36.00	36.00	60.00	✓	US 1625	1.61
P 085 070 R	85	85.00	50.00	50.00	70.00	✓	US 1630	2.88
P 100 080 R	100, 200	100.00	60.00	60.00	80.00	✓	US 2032	4.48
P 022 020	22	22.00	12.00	12.00	20.00	–	US 0608	0.06
P 022 030	22	22.00	12.00	12.00	30.00	–	US 0608	0.09
P 027 030	27	27.00	15.00	15.00	30.00	–	US 0609	0.13
P 027 045	27	27.00	15.00	15.00	45.00	–	US 0609	0.19
P 032 035	32	32.00	20.00	20.00	35.00	–	US 0810	0.20
P 032 052	32	32.00	20.00	20.00	52.00	–	US 0810	0.30
P 042 040	42	42.00	24.00	24.00	40.00	–	US 1014	0.40
P 042 060	42	42.00	24.00	24.00	60.00	–	US 1014	0.60
P 054 050	54	54.00	28.00	28.00	50.00	–	US 1219	0.87
P 054 075	54	54.00	28.00	28.00	75.00	–	US 1219	1.30
P 068 060	68	68.00	36.00	36.00	60.00	–	US 1625	1.63
P 068 090	68	68.00	36.00	36.00	90.00	–	US 1625	2.44
P 085 070	85	85.00	50.00	50.00	70.00	–	US 1630	2.86
P 085 105	85	85.00	50.00	50.00	105.00	–	US 1630	4.46
P 100 080	100, 200	100.00	60.00	60.00	80.00	–	US 2032	4.44
P 100 120	100, 200	100.00	60.00	60.00	120.00	–	US 2032	6.91



RED-BS



RED-BS Boring Head Reducer Arbor

Boring head reducer adaptor. Coupling sizes from 27 up to 100 mm and in different lengths available. External coolant only. Suited for all applications requiring high accuracy and repeatability.

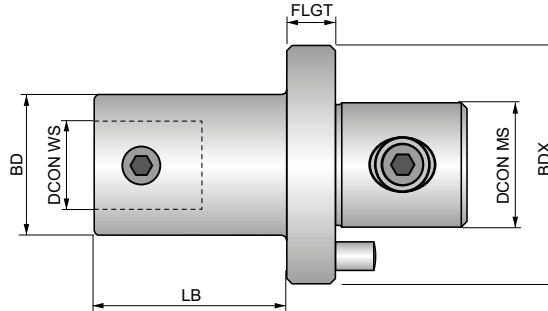

Product	CZC MS	BD	DCON MS	DHUB	DCON WS	LB	FLGT			
		[mm]	[mm]	[mm]	[mm]	[mm]	[mm]			
R 027 022 036	22	27.00	15.00	22	12.00	26.00	10	—	US 0608	0.11
R 042 022 058	22	42.00	24.00	22	12.00	48.00	10	—	US 0608	0.31
R 032 022 040	22	32.00	20.00	22	12.00	30.00	10	—	US 0608	0.17
R 054 022 086	22	54.00	28.00	22	12.00	76.00	10	—	US 0608	0.51
R 068 022 102	22	68.00	36.00	22	12.00	90.00	12	—	US 0608	0.90
R 054 027 080	27	54.00	28.00	27	15.00	70.00	10	—	US 0609	0.63
R 032 027 034	27	32.00	20.00	27	15.00	24.00	10	—	US 0609	0.18
R 042 027 050	27	42.00	24.00	27	15.00	40.00	10	—	US 0609	0.33
R 068 027 095	27	68.00	36.00	27	15.00	83.00	12	—	US 0609	0.97
R 042 032 046	32	42.00	24.00	32	20.00	36.00	10	—	US 0810	0.36
R 054 032 076	32	54.00	28.00	32	20.00	66.00	10	—	US 0810	0.63
R 068 032 090	32	68.00	36.00	32	20.00	78.00	12	—	US 0810	1.08
R 054 042 070	42	54.00	28.00	42	24.00	60.00	10	—	US 1014	0.81
R 068 042 082	42	68.00	36.00	42	24.00	70.00	12	—	US 1014	1.26
R 085 042 095	42	85.00	50.00	42	24.00	83.00	12	—	US 1014	2.06
R 068 054 072	54	68.00	36.00	54	28.00	60.00	12	—	US 1219	1.51
R 085 054 090	54	85.00	50.00	54	28.00	78.00	12	—	US 1219	2.44
R 085 068 100	68	85.00	50.00	68	36.00	88.00	12	—	US 1625	3.32
R 100 085 100	85	100.00	60.00	85	50.00	88.00	12	—	US 1630	5.05



LA-BS



LA-BS Boring Head Enlarger Adaptor

Boring head enlarger adaptor. Available in coupling size 100 mm and in different lengths to increase versatility. External coolant only. Suited for all applications requiring high accuracy and repeatability.

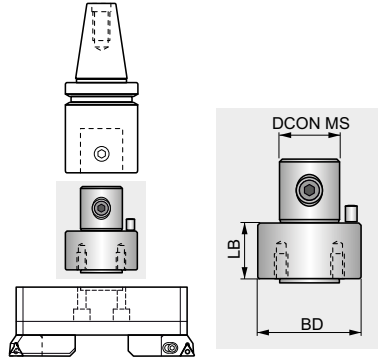

Product	CZC MS	BD [mm]	DCON MS [mm]	LB [mm]			
ADT 100 050	300, 400, 500	100.00	60.00	50.00	–	US 1240	4.35



BORING KITS



BORING KITS BORING GRADES – DESCRIPTION

1	2	3	4	5
BS	54	KIT	RC	8-43

1		2	3		4		5
Type of tool		Size	Type		ISO BARS type		Hole diameter range
BS	Boring systems	54	KIT	Set of tools	RC	for insert shape C $\kappa = 95^\circ$	8 – 43 [mm]
							8 – 100 [mm]
					TC	for insert shape T $\kappa = 90^\circ$	8 – 170 [mm]
						8 – 210 [mm]	

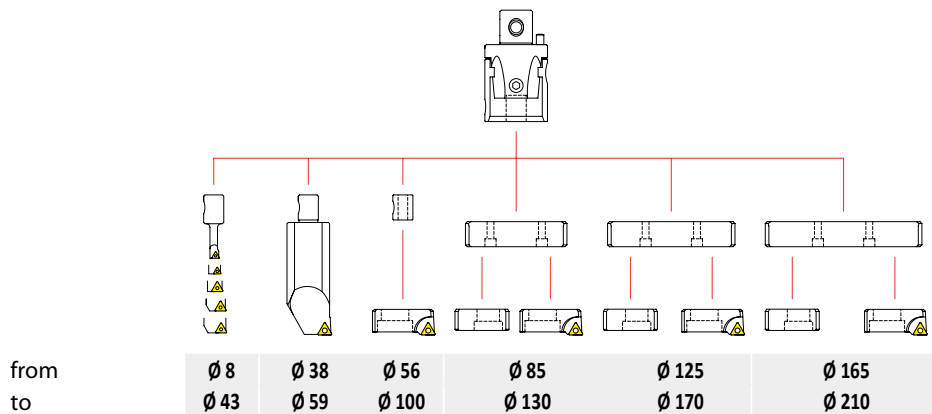

Range	Components	Order reference	
Ø 8 ~ Ø 43		BS 54 KIT RC 8-043	420
		BS 54 KIT TC 8-043	424
Ø 8 ~ Ø 100		BS 54 KIT RC 8-100	421
		BS 54 KIT TC 8-100	425
Ø 8 ~ Ø 170		BS 54 KIT RC 8-170	422
		BS 54 KIT TC 8-170	426
Ø 8 ~ Ø 210		BS 54 KIT RC 8-210	423
		BS 54 KIT TC 8-210	427

BS 54 KIT RC 8-100

BORING KITS

Ø 8 – 100

ORDER REFERENCE:



	Description	Marking	Insert	pcs.
1	Boring head	BS 054 16	-	1
2	Boring bar 6 mm	BS 06 16 R02	EP.. 0502..	1
	Boring bar 8 mm	BS 08 16 R03	CC.. 0602..	1
	Boring bar 10 mm	BS 10 16 R03	CC.. 0602..	1
	Boring bar 12 mm	BS 12 16 R03	CC.. 0602..	1
	Boring bar 16 mm	BS 16 16 R04	CC.. 09T3..	1
3	Boring bar 34 mm	BS 34 16 R04	CC.. 09T3..	2
4	Cartridge	BS 2CT R04	CC.. 09T3..	1
5	Location sleeve	BS 16 M10	-	1
6	Hexagonal key 3	HK 03	-	1
	Hexagonal key 5	HK 05	-	1
	Hexagonal key 6	HK 06	-	1
	Hexagonal key 8	HK 08	-	1
7	Torx key 7	TK07	-	1
	Torx key 8	TK08	-	1
	Torx key 15	TK15	-	1
8	Cartridge screw	CS 10 25	-	1



BS 54 KIT RC 8-170

BORING KITS

Ø 8 – 170

ORDER REFERENCE:

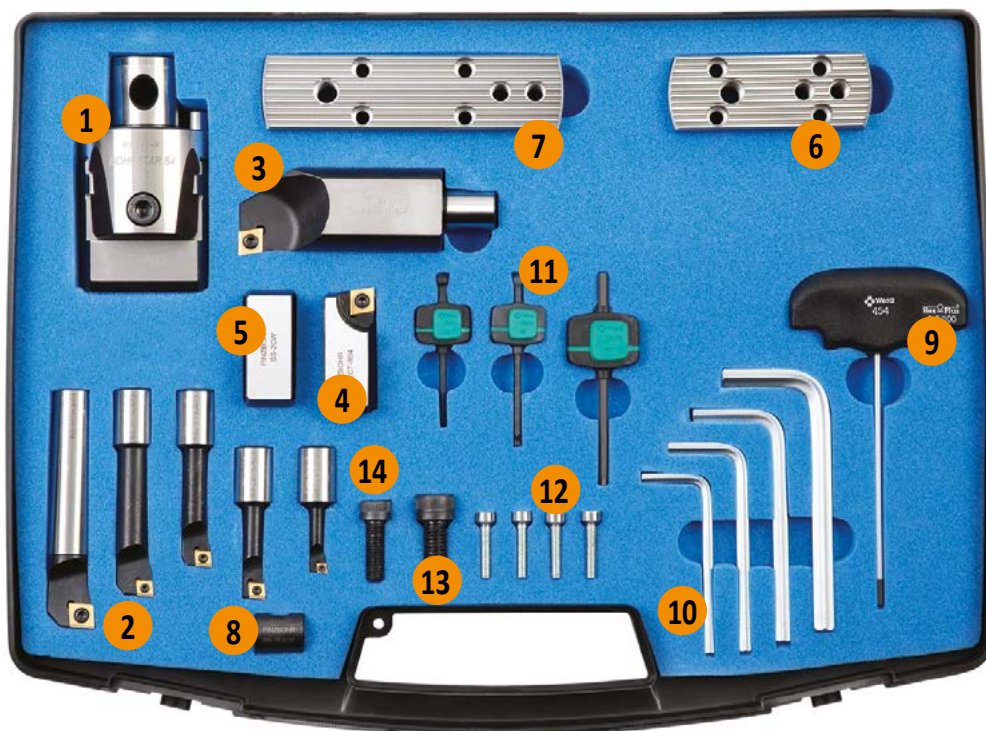

	Description	Marking	Insert	pcs.
1	Boring head	BS 054 16	-	1
2	Boring bar 6 mm	BS 06 16 R02	EP.. 0502..	1
	Boring bar 8 mm	BS 08 16 R03	CC.. 0602..	1
	Boring bar 10 mm	BS 10 16 R03	CC.. 0602..	1
	Boring bar 12 mm	BS 12 16 R03	CC.. 0602..	1
	Boring bar 16 mm	BS 16 16 R04	CC.. 09T3..	1
3	Boring bar 34 mm	BS 34 16 R04	CC.. 09T3..	2
4	Cartridge	BS 2CT R04	CC.. 09T3..	1
5	Counterweight	BS 2CW	-	1
6	Small plate	BS SP 85 130	-	1
7	Medium plate	BS SP 125 170	-	1
8	Location sleeve	BS 16 M10	-	1
9	Adjusting key	AK 03	-	1
10	Hexagonal key 4	HK 04	-	1
	Hexagonal key 5	HK 05	-	1
	Hexagonal key 6	HK 06	-	1
	Hexagonal key 8	HK 08	-	1
11	Torx key 7	TK07	-	1
	Torx key 8	TK08	-	1
	Torx key 15	TK15	-	1
12	Insert fixing screws	D 27 21	-	4
13	Cartridge screw	CS 10 25	-	1
14	Counterweight screw	CS 08 25	-	1

∅ 8 – 210

ORDER REFERENCE:

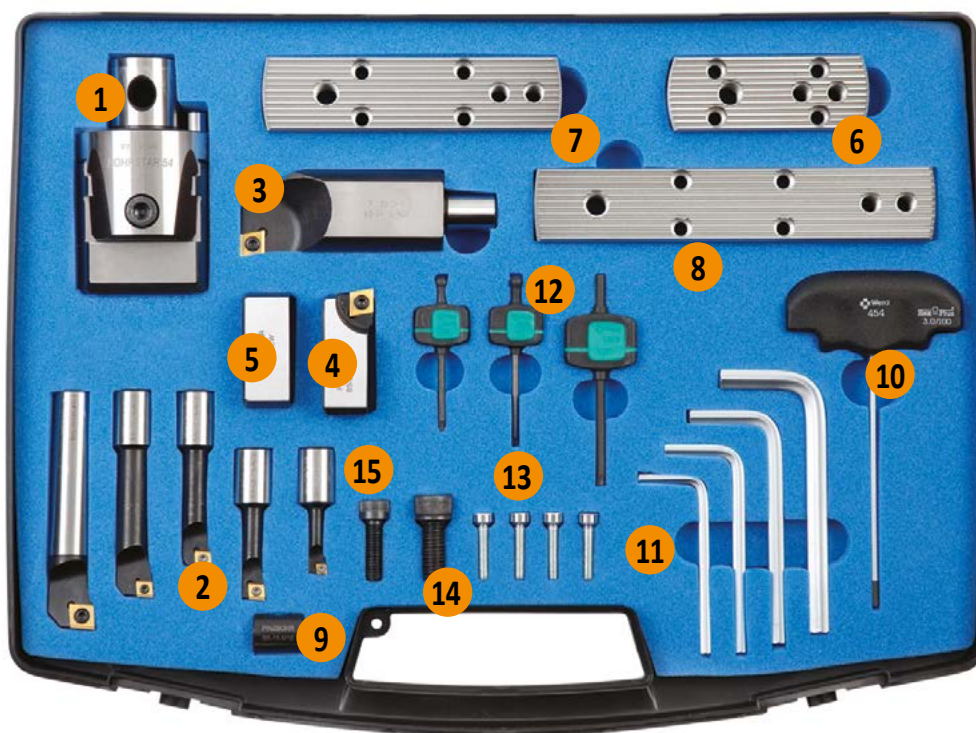

	Description	Marking	Insert	pcs.
1	Boring head	BS 054 16	–	1
2	Boring bar 6 mm	BS 06 16 R02	EP.. 0502..	1
	Boring bar 8 mm	BS 08 16 R03	CC.. 0602..	1
	Boring bar 10 mm	BS 10 16 R03	CC.. 0602..	1
	Boring bar 12 mm	BS 12 16 R03	CC.. 0602..	1
	Boring bar 16 mm	BS 16 16 R04	CC.. 09T3..	1
3	Boring bar 34 mm	BS 34 16 R04	CC.. 09T3..	2
4	Cartridge	BS 2CT R04	CC.. 09T3..	1
5	Counterweight	BS 2CW	–	1
6	Small plate	BS SP 85 130	–	1
7	Medium plate	BS SP 125 170	–	1
8	Large plate	BS SP 165 210	–	1
9	Location sleeve	BS 16 M10	–	1
10	Adjusting key	AK 03	–	1
11	Hexagonal key 4	HK 04	–	1
	Hexagonal key 5	HK 05	–	1
	Hexagonal key 6	HK 06	–	1
	Hexagonal key 8	HK 08	–	1
12	Torx key 7	TK07	–	1
	Torx key 8	TK08	–	1
	Torx key 15	TK15	–	1
13	Insert fixing screws	D 27 21	–	4
14	Cartridge screw	CS 10 25	–	1
15	Counterweight screw	CS 08 25	–	1



BS 54 KIT TC 8-100

BORING KITS

Ø 8 – 100

ORDER REFERENCE:



	Description	Marking	Insert	pcs.
1	Boring head	BS 054 16	-	1
2	Boring bar 6 mm	BS 06 16 T01	TC.. 06T1..	1
	Boring bar 8 mm	BS 08 16 T01	TC.. 06T1..	1
	Boring bar 10 mm	BS 10 16 T02	TC.. 0902..	1
	Boring bar 12 mm	BS 12 16 T02	TC.. 0902..	1
	Boring bar 16 mm	BS 16 16 T02	TC.. 0902..	1
3	Boring bar 34 mm	BS 34 16 T04	TC.. 16T3..	1
4	Cartridge	BS 2CT T04	TC.. 16T3..	1
5	Location sleeve	BS 16 M10	-	1
6	Hexagonal key 3	HK 03	-	1
	Hexagonal key 5	HK 05	-	1
	Hexagonal key 6	HK 06	-	1
	Hexagonal key 8	HK 08	-	1
7	Torx key 6	TK06	-	1
	Torx key 7	TK07	-	1
	Torx key 15	TK15	-	1
8	Cartridge screw	CS 10 25	-	1

BS 54 KIT TC 8-170

BORING KITS

∅ 8 – 170

ORDER REFERENCE:

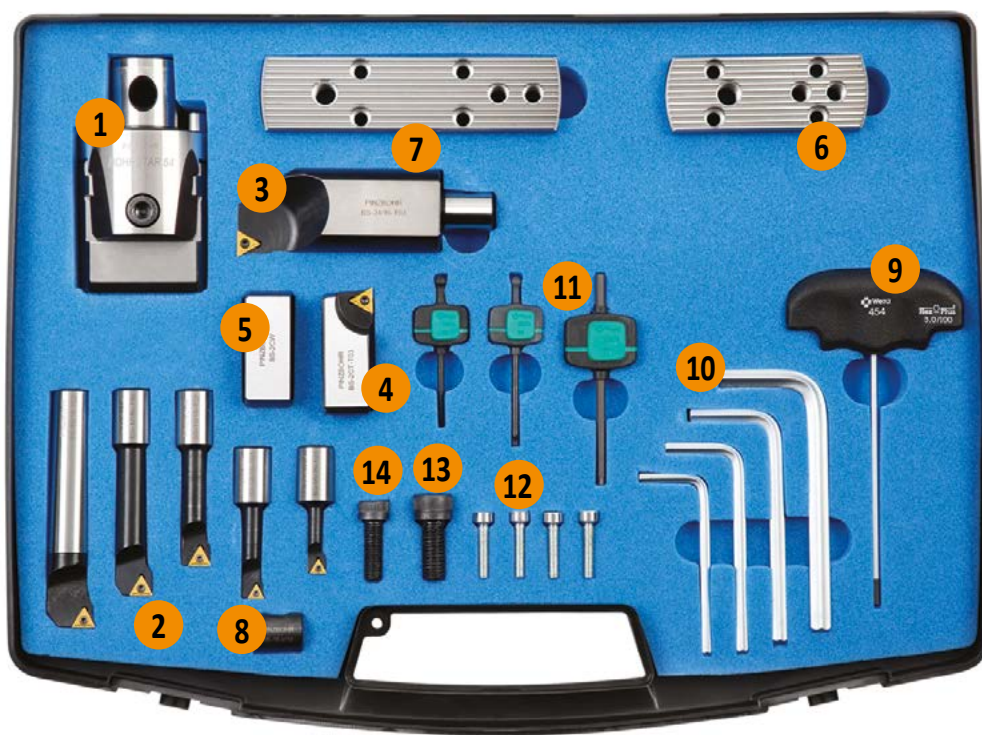

	Description	Marking	Insert	pcs.
1	Boring head	BS 054 16	-	1
2	Boring bar 6 mm	BS 06 16 T01	TC.. 06T1..	1
	Boring bar 8 mm	BS 08 16 T01	TC.. 06T1..	1
	Boring bar 10 mm	BS 10 16 T02	TC.. 0902..	1
	Boring bar 12 mm	BS 12 16 T02	TC.. 0902..	1
	Boring bar 16 mm	BS 16 16 T02	TC.. 0902..	1
3	Boring bar 34 mm	BS 34 16 T04	TC.. 16T3..	1
4	Cartridge	BS 2CT T04	TC.. 16T3..	1
5	Counterweight	BS 2CW	-	1
6	Small plate	BS SP 85 130	-	1
7	Medium plate	BS SP 125 170	-	1
8	Location sleeve	BS 16 M10	-	1
9	Adjusting key	AK 03	-	1
10	Hexagonal key 4	HK 04	-	1
	Hexagonal key 5	HK 05	-	1
	Hexagonal key 6	HK 06	-	1
	Hexagonal key 8	HK 08	-	1
11	Torx key 6	TK06	-	1
	Torx key 7	TK07	-	1
	Torx key 15	TK15	-	1
12	Insert fixing screws	D 27 21	-	4
13	Cartridge screw	CS 10 25	-	1
14	Counterweight screw	CS 08 25	-	1



BS 54 KIT TC 8-210

BORING KITS

Ø 8 – 210

ORDER REFERENCE:

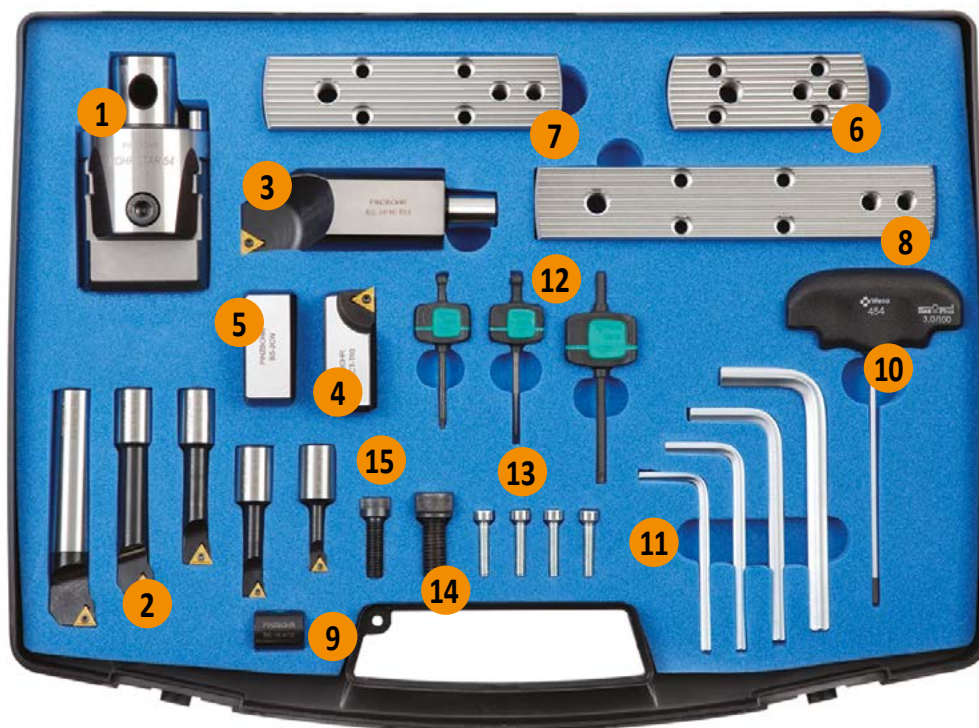

	Description	Marking	Insert	pcs.
1	Boring head	BS 054 16	–	1
2	Boring bar 6 mm	BS 06 16 T01	TC.. 06T1..	1
	Boring bar 8 mm	BS 08 16 T01	TC.. 06T1..	1
	Boring bar 10 mm	BS 10 16 T02	TC.. 0902..	1
	Boring bar 12 mm	BS 12 16 T02	TC.. 0902..	1
	Boring bar 16 mm	BS 16 16 T02	TC.. 0902..	1
3	Boring bar 34 mm	BS 34 16 T04	TC.. 16T3..	1
4	Cartridge	BS 2CT T04	TC.. 16T3..	1
5	Counterweight	BS 2CW	–	1
6	Small plate	BS SP 85 130	–	1
7	Medium plate	BS SP 125 170	–	1
8	Large plate	BS SP 165 210	–	1
9	Location sleeve	BS 16 M10	–	1
10	Adjusting key	AK 03	–	1
11	Hexagonal key 4	HK 04	–	1
	Hexagonal key 5	HK 05	–	1
	Hexagonal key 6	HK 06	–	1
	Hexagonal key 8	HK 08	–	1
12	Torx key 6	TK06	–	1
	Torx key 7	TK07	–	1
	Torx key 15	TK15	–	1
13	Insert fixing screws	D 27 21	–	4
14	Cartridge screw	CS 10 25	–	1
15	Counterweight screw	CS 08 25	–	1



DORMER PRAMET



ALWAYS CONNECT

No wifi or internet connection? The machining calculator works perfectly even when you are offline, making sure it's always available when you need it. **Simply Reliable.**





BORING
TECHNICAL INFORMATION



WORKPIECE MATERIAL GROUP (WGM)

ISO To select a cutting grade and geometry for a broad range of workpiece materials

General definition
i.e. Steel, Stainless Steel...

P **M** **K** **N** **S** **H**

Subgroup To navigate and select a tool by suitability for a more specific range of workpiece materials

Definition by structure/composition
i.e. Plain Carbon Steel, Alloy Steel...

P **M** **K** **N** **S** **H**

P1

P2

P3

P4

WGM To select and provide cutting conditions within a bandwidth of $\pm 10\%$

Definition by hardness/ultimate tensile strength
i.e. $160 < 220$ HB, $620 < 900$ N/mm² ...

P

P1 **P1.1** **P1.2** **P1.3**

P2 **P2.1** **P2.2** **P2.3**

P3 **P3.1** **P3.2** **P3.3**

P4 **P4.1** **P4.2** **P4.3**

ABOUT DORMER PRAMET'S WORKPIECE MATERIAL CLASSIFICATION

Workpiece Material Groups (WGM) are used to support easy and reliable selection of the right cutting tool and starting values for machining conditions in particular applications.

Dormer Pramet classifies workpiece materials into six different coloured groups;

- **Blue:** Steel and cast steel (P-group)
- **Yellow:** Stainless steel (M-group)
- **Red:** Cast iron (K-group)
- **Green:** Non-ferrous metals (N-group)
- **Brown:** High-temperature alloys (S-group)
- **Grey:** Hardened materials (H-group)

Each of these are divided into subgroups on the basis of their structure and/or composition. For example, P-group steel and cast steel is split into four subgroups, namely;

- **P1** – Free machining steel
- **P2** – Plain carbon steel
- **P3** – Alloy steel
- **P4** – Tool steel

A final division includes material properties, such as hardness and ultimate tensile strength. This is to provide our customers with a complete tool recommendation, including starting values for cutting speed and feed.

The table on the next page includes a description of each workpiece material group, as well as examples of commonly used designations.

WORKPIECE MATERIAL GROUP (WMG)

ISO group	Subgroup	WMG (Work Material Group)	k_{vc}	Examples of material (AISI, EN, DIN, ČSN, GB, SS, STN, BS, UNE, AFNOR, ASTM, GOST, UNS, UNI, ...)
P Steel and cast steel (steels with alloy content ≤ 10 % and a hardness of < 45HRC)	P1 Free machining steel (carbon steels with increased machinability)	P1.1 Free machining sulfurized carbon steel with a hardness of < 220 HB	1.33	AISI 1108, EN 15522, DIN 1.0723, SS 1922, ČSN 11120, BS 210A15, UNE F.210F, GB Y15, AFNOR 10F1, GOST A30, UNI CF10S20
		P1.2 Free machining sulfurized and phosphorized carbon steel with a hardness of < 180 HB	1.49	AISI 1211, EN 115Mn30, DIN 1.0715, SS 1912, ČSN 11109, BS 230M7, UNE F.2111, GB Y15, AFNOR S250, GOST A40G, UNI CF95Mn28
		P1.3 Free machining sulfurized/phosphorized and leaded carbon steel with a hardness of < 160 HB	1.53	AISI 12L13, EN 115MnPb30, DIN 1.0718, SS 1914, ČSN 12110, BS 210M16, UNE F.2114, GB Y15Pb, AFNOR S250Pb, GOST A35G2, UNI CF10SPb20
	P2 Plain carbon steel (steels comprised of mainly iron and carbon)	P2.1 Plain low carbon steel containing < 0.25 % C with a hardness of < 180 HB	1.14	AISI 1015, EN C15, DIN 1.0401, SS 1350, ČSN 11301, BS 080A15, UNE F.111, GB 15, AFNOR C18RR, GOST S22ps, UNI Fe360
		P2.2 Plain medium carbon steel containing < 0.55 % C with a hardness of < 240 HB	1.00	AISI 1030, EN C30, DIN 1.0528, SS 1550, ČSN 12031, BS 080M32, UNE F.1130, GB 30, AFNOR AF50C30, GOST 30G, UNI Fe590
		P2.3 Plain high carbon steel containing > 0.55 % C, with a hardness of < 300 HB	0.89	AISI 1060, EN C60, DIN 1.0601, SS 1655, ČSN 12061, BS 080A62, UNE F.513, GB 60, AFNOR 1C60, GOST 60G, UNI C60
	P3 Alloy steel (carbon steels with an alloying content ≤ 10 %)	P3.1 Alloy steel with a hardness of < 180 HB	0.92	AISI 5015, EN 16Mo3, DIN 1.5415, SS 2912, ČSN 15020, BS 1501-240, UNE F.2601, GB 16Mo, AFNOR 15D3, GOST 15M, UNI 16Mo3KW
		P3.2 Alloy steel with a hardness of 180 – 260 HB	0.74	AISI 4140, EN 42CrMo4, DIN 1.7225, SS 2244, ČSN 15142, BS 708M40, UNE F.8232, GB 42CrMo, AFNOR 42CD4, GOST 40CHFA, UNI 42CrMo4
		P3.3 Alloy steel with a hardness of 260 – 360 HB	0.63	AISI 4140, EN 42CrMo4, DIN 1.7225, SS 2244, ČSN 15142, BS 708M40, UNE F.8232, GB 42CrMo, AFNOR 42CD4, GOST 40CHFA, UNI 42CrMo4
	P4 Tool steel (special alloy steel for tools, dies and molds)	P4.1 Tool steel with a hardness of < 26 HRC	0.55	AISI D2, EN X155CrVMo12-1, DIN 1.2370, SS 2736, ČSN 19573, BS BD2, UNE F.520A, GB Cr12Mo1V1, AFNOR Z160CDV12, GOST Ch12MF, UNI X155CrVMo121KU
		P4.2 Tool steel with a hardness of 26 – 39 HRC	0.47	AISI D2, EN X155CrVMo12-1, DIN 1.2370, SS 2736, ČSN 19573, BS BD2, UNE F.520A, GB Cr12Mo1V1, AFNOR Z160CDV12, GOST Ch12MF, UNI X155CrVMo121KU
		P4.3 Tool steel with a hardness of 39 – 45 HRC	0.38	AISI D2, EN X155CrVMo12-1, DIN 1.2370, SS 2736, ČSN 19573, BS BD2, UNE F.520A, GB Cr12Mo1V1, AFNOR Z160CDV12, GOST Ch12MF, UNI X155CrVMo121KU

WORKPIECE MATERIAL GROUP (WMG)



ISO group	Subgroup	WMG (Work Material Group)	k _{vc}	Examples of material (AISI, EN, DIN, ČSN, GB, SS, STN, BS, UNE, AFNOR, ASTM, GOST, UNS, UNI, ...)
M Stainless steel (corrosion resistant steels with ≥ 11 % chromium content)	M1 Ferritic stainless steel (straight chromium non-hardenable alloys)	M1.1 Stainless steel, ferritic with a hardness of < 160 HB	1.22	AISI 5429, EN X7Cr14, DIN 1.4001, SS 2326, BS 434517, UNE F.3401, AFNOR Z8C12, GOST 08Ch13, UNI X6CrTi12
		M1.2 Stainless steel, ferritic with a hardness of 160 – 220 HB	1.03	AISI 446, EN X10CrAl24, DIN 1.4762, SS 2322, ČSN 17113, BS 430517, UNE F.3154, GB 10Cr17, AFNOR Z10CA524, GOST 12Ch17, UNI X16Cr26
		M2.1 Stainless steel, martensitic with a hardness of < 200 HB	1.08	AISI 430F, EN X14CrMo517, DIN 1.4104, SS 2383, ČSN 17140, BS 410S21, UNE F.3117, AFNOR Z10CF17, UNI X10Cr517
	M2 Martensitic stainless steel (straight chromium hardenable alloys)	M2.2 Stainless steel, martensitic with a hardness of 200 – 280 HB	0.89	AISI 440C, EN X105CrMo17, DIN 1.4125, SS 2385, ČSN 17023, BS 425C11, UNE F.3402, GB 102Cr17Mo, AFNOR Z100CD17, GOST 95Ch18, UNI 6X6CrNi 13 04
		M2.3 Stainless steel, martensitic with a hardness of 280 – 380 HB	0.75	AISI 420, EN X45Cr13, DIN 1.4034, ČSN 17029, BS 425C11, UNE F.3405, AFNOR Z44C14, GOST 20X17H12, UNI X30Cr13
		M3.1 Stainless steel, austenitic with a hardness of < 200 HB	1.00	AISI 304, EN X5CrNi18-12, DIN 1.4303, SS 2352, ČSN 17249, BS 305S17, UNE F.3513, GB 10Cr18Ni12, AFNOR Z8CN18.12, UNI X7CrNi18 10
	M3 Austenitic stainless steel (chromium-nickel and chromium-nickel-manganese alloys)	M3.2 Stainless steel, austenitic with a hardness of 200 – 260 HB	0.86	AISI 309, EN X15CrNiSi20-12, DIN 1.4828, ČSN 17251, BS 309S24, UNE F.3312, GB 1G23Ni13, AFNOR Z15CNS20.12, GOST 20Ch20Ni452, UNI 16CrNi23 14
		M3.3 Stainless steel, austenitic with a hardness of 260 – 300 HB	0.77	AISI 5848, EN X45CrNiW18-9, DIN 1.4873, BS 331540, UNE F.3211, AFNOR Z35CNW514-4, UNI X45CrNiW 18 9
		M4.1 Stainless steel, austenitic-ferritic or super-austenitic with a hardness of < 300 HB	0.75	AISI 329, EN X1-NiCrMoCu25-20-5, DIN 1.4539, SS 2562, ČSN 17265, BS 318S13, UNE F.3552, GB 022Cr25NiMo2N, AFNOR Z1NCUDU25.20
	M4 Super-austenitic, Duplex or Precipitation Hardening stainless steel (austenitic alloys with > 20 % Ni, austenitic-ferritic microstructure or precipitation hardened)	M4.2 Stainless steel, precipitation hardening austenitic with a hardness of 300 – 380 HB	0.64	AISI 631 (17-7PH), EN X7CrNiAl17-7, DIN 1.4568, SS 2388, ČSN 17465, BS 301S13, UNE F.3217, GB 07Cr17Ni7Al, AFNOR Z9CNAl17-07, GOST 09Ch17Ni7Al, UNI X53CrMnNiN21 9



WORKPIECE MATERIAL GROUP (WMG)

ISO group	Subgroup	WMG (Work Material Group)	k_{wc}	Examples of material (AISI, EN, DIN, ČSN, GB, SS, STN, BS, UNE, AFNOR, ASTM, GOST, UNS, UNI, ...)
K Cast Iron (castings of iron and carbon alloys with > 2 % carbon content)	K1 Gray iron (GG) (iron-carbon castings with a lamellar graphite microstructure)	K1.1 Gray iron, ferritic or ferritic-pearlitic with a hardness of < 180 HB	1.35	ASTM A48 Grade 20 (F11401), EN-JL-100, DIN GG-10 (0.6010), SS 0110, STN 422410, BS Grade 150, UNE FG10, GB HAT 100, AFNOR Fc10D, GOST SC 10, UNI G10
		K1.2 Gray iron, ferritic-pearlitic or pearlitic with a hardness of 180 – 240 HB	1.00	ASTM A48 Grade 30 (F12101), EN-JL-1030, DIN GG-20 (0.6020), SS 0120, STN 422420, BS Grade 220, UNE FG20, GB HT200, AFNOR Fc20D, GOST Ч420, UNI G20
		K1.3 Gray iron, pearlitic with a hardness of 240 – 280 HB	0.75	ASTM A48 Grade 50 (F13501), EN-JL-1060, DIN GG-35 (0.6035), SS 0135, STN 422435, BS Grade 350, UNE FG35, GB HAT300, AFNOR Fc35D, GOST SC35, UNI G35
	K2 Malleable iron (GTS/GTW) (heat-treated iron-carbon castings with a graphite-free microstructure)	K2.1 Malleable iron, ferritic with a hardness of < 160 HB	1.39	ASTM A602 Grade M3210 (F20000), EN-JM-1130, DIN GTS-35 (0.8135), SS 0815, BS B340/12, UNE Type A, AFNOR MN 35-10, GOST K435-10
		K2.2 Malleable iron, ferritic or pearlitic with a hardness of 160 – 200 HB	1.13	ASTM A602 Grade M4504 (F20001), EN-JM-1040, DIN GTS-50-05 (0.8045), BS P50-05, AFNOR MB 45-7
		K2.3 Malleable iron, pearlitic with a hardness of 200 – 240 HB	0.90	ASTM A602 Grade M7002 (F20004), EN-JM-1140, DIN GTS-45 (0.8145), SS 0854, STN 422540, BS P 45-06, UNE Typ B, AFNOR MP 50-5, GOST K445-7, UNI GMN 45
	K3 Ductile iron (GGG) (iron-carbon castings with a nodular graphite microstructure)	K3.1 Ductile (nodular/spheroidal) iron, ferritic with a hardness of < 180 HB	1.23	ASTM A536 Grade 60-40-18 (F32800), EN-JS-1030, DIN GGG-40 (0.7040), SS 0717, STN 422304, BS 420/12, UNE FGE 42-12, GB QT 400, AFNOR FGS 400-12, GOST B440
		K3.2 Ductile (nodular/spheroidal) iron, ferritic or pearlitic with a hardness of 180 – 220 HB	0.94	ASTM A536 Grade 80-55-06 (F33800), EN-JS-1050, DIN GGG-50 (0.7050), SS 0727, STN 422305, BS 500/7, UNE FGE 50-7, GB QT 500-7, AFNOR FGS 500-7, GOST B450
		K3.3 Ductile (nodular/spheroidal) iron, pearlitic with a hardness of 220 – 260 HB	0.76	ASTM A536 Grade 100-70-03 (F34800), EN-JS-1060, DIN GGG-60 (0.7060), SS 0732, STN 422306, BS 600/3, UNE FGT 0-2, GB QT 600-3, AFNOR FGS 600-3, GOST B460
	K4 Austenitic or austempered ductile iron (NI-Resist/ADI) (iron-carbon alloy castings with an austenitic or ausferrite microstructure)	K4.1 Austenitic cast iron with a hardness of < 180 HB	1.14	ASTM A436 Type 1 (L-NiCuCr 15 6 2, F41000), EN-JL-3011, DIN GGL-NiMn 13 7 (0.6652), SS 0523, BS Grade F1, AFNOR FGL-Ni13Mn7, GOST S-NiMn 13 7
		K4.2 Austenitic cast iron with a hardness of 180 – 240 HB	0.86	ASTM A439 Type D-2B (S-NiCr 20 3, F43001), EN-JS-3021, DIN GGG-NiMn 23 4, SS 0776, BS Grade S2M, AFNOR FGS Ni23 Mn4, GOST ЧH19X3U
		K4.3 Austempered ductile iron with a hardness of 240 – 280 HB	0.63	ASTM A897 Grade 110-70-11
	K5 Compacted graphite iron (CGI) (iron-carbon castings with a vermicular graphite structure)	K4.4 Austempered ductile iron with a hardness of 280 – 320 HB	0.54	ASTM A897 Grade 125-80-10, EN-JS-1100, DIN GGG-90 (5.3400)
K4.5 Austempered ductile iron with a hardness of 320 – 360 HB		0.45	ASTM A897 Grade 2 (150-110-07), EN-JS-1110, DIN GGG-100 (5.3403)	
K5	K5.1 Vermicular, compacted graphite iron with a hardness of < 180 HB	1.29	ASTM A842 Grade 300, EN-GJV-300, DIN GGV 30, GOST ЧBT30,	
	K5.2 Vermicular, compacted graphite iron with a hardness of 180 – 220 HB	0.97	ASTM A842 Grade 350, EN-GJV-350, DIN GGV 35 (5.2200), GOST ЧBT30,	
	K5.3 Vermicular, compacted graphite iron with a hardness of 220 – 260 HB	0.75	ASTM A842 Grade 450, EN-GJV-450, DIN GGV 45, GOST ЧBT45,	



WORKPIECE MATERIAL GROUP (WMG)

ISO group	Subgroup	WMG (Work Material Group)	k _{vc}	Examples of material (AISI, EN, DIN, ČSN, GB, SS, STN, BS, UNE, AFNOR, ASTM, GOST, UNS, UNI, ...)
N Non-ferrous metals (metals including alloys without an appreciable amount of iron)	N1 Wrought aluminium	N1.1 Pure aluminium and wrought aluminium alloys with a hardness of < 60 HB	1.33	UNS A91200, EN AL99.6, DIN 3.0205, SS 4010, STN 424009, BS 1C, UNE L-3001, GB L5, AFNOR A4, GOST A1C, UNI 3567
		N1.2 Wrought aluminium alloys with a hardness of 60 – 100 HB	1.00	UNS A93004, EN AlMn0.5Mg0.5, DIN 3.0505, SS 4054, STN 424432, BS N31, UNE L-3831, GB LF2, AFNOR A-M1, GOST AMu, UNI 3568
		N1.3 Wrought aluminium alloys with a hardness of 100 – 150 HB	0.67	UNS A95083, EN AlMg4.5Mn0.7, DIN 3.3547, SS 4140, STN 424415, BS N8, UNE L-3321, GB AlMg4.5Mn, AFNOR A-G4.5Mn, GOST Amg 4.5, UNI P-AlMg4.4
	N2 Cast aluminium	N2.1 Cast aluminium alloys with a hardness of < 75 HB	0.67	UNS A02080, EN AlCu45, BS LM11, STN 424331, UNE AlSi1Cu, GOST AMg5K, UNI G-AlSi7Mg
		N2.2 Cast aluminium alloys with a hardness of 75 – 90 HB	0.60	UNS A02420, EN AlCu4Ni2Mg2, SS AlSi7MgFe, BS LM6, STN 424519, UNE Al-7SiMg, AFNOR A-S7G, GOST AK7, UNI G-AlSi7Mg
		N2.3 Cast aluminium alloys with a hardness of 90 < 140 HB	0.43	UNS A03360, EN G-ALCu4NiMg2, SS AlSi10Mg, STN 424336, BS LM 30, AFNOR A-S10G, UNI G-AlSi9Mg
	N3 Copper or copper alloys	N3.1 Free-cutting copper-alloys materials with excellent machining properties	0.70	UNS C14700, EN CuPb1P, DIN 2.1498, STN 423214, BS C111, AFNOR CuZn35Pb2, GOST L63-3, UNI CuS(P0.01)
		N3.2 Short-chip copper-alloys with good to moderate machining properties	0.41	UNS C81540, EN CuNi25Cr, DIN 2.0857, STN 423220, BS NS113, UNE CuSn12, AFNOR CuZn40, GOST L60, UNI P-CuZn-40
		N3.3 Electrolytic copper and long-chip copper-alloys with moderate to poor machining properties	0.21	UNS C10100, EN CuAg0.1, DIN 2.1203, SS 5010, UNE CuSi3Mn1, AFNOR Cu-C2, GOST M1f, UNI Cu-0F
	N4 Polymers (synthetic or semi-synthetic materials)	N4.1 Thermoplastic polymers	0.70	ABS, Acryl, Duraplast, Elastomer, EP, Epoxid, FEP, Fluor, Gummi, Kautschuk, Latex, ME, MPF, PA, PC, PE, PEEK, PEI, PES, PET, PF, Phenolharze, PI, PMMA, Polyamide, Polyester, Polyolefine, Polysulfon, POM, PP, PPE, PPS, PS, PSU, PTFE, PU, PUR, PVDF, SAN, SI, Styrol, UF, Ureol
		N4.2 Thermosetting polymers	0.27	Aramid, Epoxy, Fluoropolymer, Methacrylate, Melamine, Phenolic, Polyester, Polyimide, Polymethacrylimide, Polyurethane
		N4.3 Reinforced polymers or composites	0.29	CFK, GFK, GMT, Honeycomb, Kevlar, LFT, Organo, SMC
	N5 Graphite	N5.1	1.0	CGM-1, CM-00, GM-10, GM-11, GR030, GR030PI, GR060, GR060PI, GR125, MC-01, MC-01R0, MC-03, MC-03M, IG11, IG-15, IG-32, IG-43, IG-45, IG-70, ISEM-1, ISEM-2, ISEM-3, R8340, R8500X, Technograph 15, Technograph 30, ISO-63, EDM C-3, EDM1, EDM3, ISO-90, ISO-93, ISO-95, R8510, R8650, R8650



WORKPIECE MATERIAL GROUP (WMG)

ISO group	Subgroup	WMG (Work Material Group)	$k_{w,g}$	Examples of material (AISI, EN, DIN, ČSN, GB, SS, STN, BS, UNE, AFNOR, ASTM, GOST, UNS, UNI, ...)
S High-temperature alloys (superalloys with high temperature strength and corrosion resistant surpassing that of stainless steel)	S1 Titanium or titanium alloys	S1.1 Titanium or titanium alloys, with a hardness of <200 HB	1.94	UNS R50250 (Grade 1), EN Ti 99.6, DIN 3.7035, BS TA.2, UNE Ti-Po2, AFNOR T-40, GOST BT1-00, AISI R50250, 3.7025, T35, 2TA1, R50400, 3.7035, 2TAZ,
		S1.2 Titanium alloys, with a hardness of 200 – 280 HB	1.72	UNS R56404 (Grade 29), EN Ti2Cu, DIN 3.7124, BS TA.21, UNE Ti-P11, AFNOR T-U2, AISI TA6V, Ti-6Al-4V, Ti 10.2.3, Ti5553
		S1.3 Titanium alloys, a hardness of 280 – 360 HB	1.44	UNS R54250 (Grade 38), EN TiAl6V4, DIN 3.7165, ČSN TiAl6VELI, BS TA. 13, UNE Ti-P63, AFNOR T-A6V, GOST BT6, AISI TA6V, Ti-6Al-4V, Ti 10.2.3, Ti5553
	S2 Fe-based high-temperature alloys	S2.1 High-temperature Fe-based alloys with a hardness of <200 HB	1.33	UNS N08801 (Incoloy 801), EN X8 NiCrAlTi31-21, DIN 1.4959, BS NA 15, AFNOR Z8NC33-21, AISI A-286, Discaloy, Haynes 556, Inconel 909, Greek Ascology
		S2.2 High-temperature Fe-based alloys with a hardness of 200 – 280 HB	1.17	UNS N19907, EN X6NiCrTiMoVB25-15-2, DIN 1.4980, SS 2570, BS HR52, AFNOR Z6NCTDV25.15B, GOST 36HXT10, AISI A-286, Discaloy, Haynes 556, Inconel 909, Greek Ascology
		S3.1 High-temperature Ni-based alloys with a hardness of <280 HB	1.00	UNS A09706 (Inconel 706), EN NiCr25FeAl, DIN 2.4856, BS HR 6, ČSN Inconel 625, UNE F.3313, GB 1Cr16Ni35, AFNOR NC22FeDNB, GOST XH38BT, AISI Inconel 718, 706 Waspalloy, Udimet 720, Inconel 625
	S3 Ni-based high-temperature alloys	S3.2 High-temperature Ni-based alloys with a hardness of 280 – 360 HB	0.83	UNS N07001, EN NiCr20Co13Mo4Ti3Al, DIN 2.4654, BS HR 2, ČSN Waspalloy, AFNOR NCKD 20ATV, GOST XH80T5K0, AISI Inconel 718, 706 Waspalloy, Udimet 720, Inconel 625
		S4 Co-based high-temperature alloys	S4.1 High-temperature Co-based alloys with a hardness of <240 HB	0.78
	S4.2 High-temperature Co-based alloys with a hardness of 240 – 320 HB		0.67	UNS R30016 (Stellite 6b), EN CoCr20W15Ni, DIN 2.4964, AFNOR KC 20 WN, GOST ЛК52, AISI Haynes 25, Stellite 21, 31



WORKPIECE MATERIAL GROUP (WMG)

ISO group	Subgroup	WMG (Work Material Group)	k_{vg}	Examples of material (AISI, EN, DIN, ČSN, GB, SS, STN, BS, UNE, AFNOR, ASTM, GOST, UNS, UNI, ...)
H Hardened materials (any engineering metal with a hardness > 45 HRC)	H1 Chilled cast iron	H1.1 Chilled cast iron with a hardness of < 440 HB	1.52	UNS F45001, EN-GJS-1050-6, DIN 5.3406, SS 0512, BS Grade 2A
		H2.1 Hardened cast iron with a hardness < 55 HRC	0.90	UNS F45003, EN-GJS-1400-1, DIN 5.3405, SS 0457, BS Grade 3D
	H2 Hardened cast iron	H2.2 Hardened cast iron with a hardness > 55 HRC	0.77	UNS F45003, EN G-X260NiCr4-2, DIN 0.9620, SS 0466, BS Grade S
		H3.1 Hardened steel with a hardness of < 51 HRC	1.00	AISI 4135, EN 34CrMo4, DIN 1.7220, SS 2234, STN 415131, BS 198, UNE F.1250, GB 35CrMo, AFNOR 35CD4, GOST AC38XTM, UNI 35CrMo4KB
	H3 Hardened steel < 55 HRC	H3.2 Hardened steel with a hardness of 51 – 55 HRC	0.82	AISI 4135, EN 34CrMo4, DIN 1.7220, SS 2234, STN 415131, BS 198, UNE F.1250, GB 35CrMo, AFNOR 35CD4, GOST AC38XTM, UNI 35CrMo4KB
		H4 Hardened steel > 55 HRC	H4.1 Hardened steel with a hardness of 55 – 59 HRC	0.64
	H4.2 Hardened steel with a hardness of > 59 HRC		0.54	UNS T31501, EN 100MnCrW4, DIN 1.2510, SS 2140, STN 419413, BS B01, UNE F.5220, GB 9CrWMn, AFNOR 90MnWCrV5, GOST 9XBТ, UNI 95MnWCr5KU

GEOMETRY OF CUTTING NEGATIVE INSERTS – CLAMPING DESIGNATION ISO P, M, D

FF

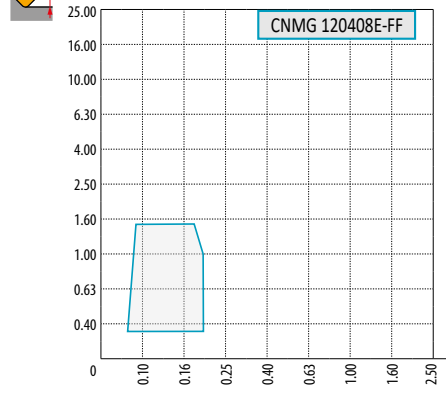
P	M	K	N	S	H
■	■	▣			
f		0.06 – 0.25			
a _p		0.2 – 1.6			

? CNMG, DNMG, TNMG, VNMG, WNMG

FM

P	M	K	N	S	H
■	▣	■		▣	
f		0.1 – 0.5			
a _p		0.4 – 5.0			

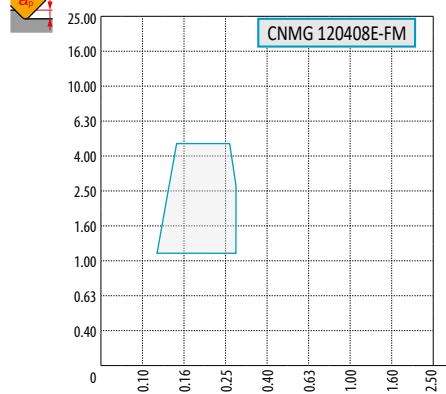
? CNMG, DNMG, SNMG, TNMG, VNMG, WNMG

M

P	M	K	N	S	H
■		■			▣
f		0.17 – 0.80			
a _p		0.8 – 8.0			

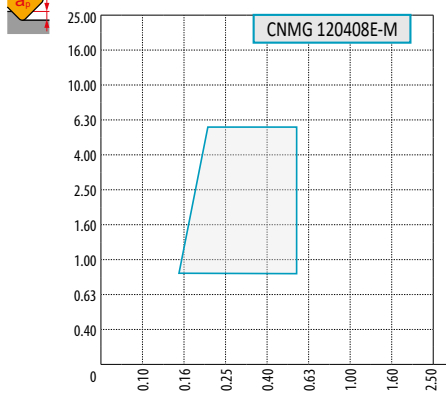
? CNMG, DNMG, SNMG, TNMG, VNMG, WNMG

NF

P	M	K	N	S	H
■	■	▣	▣	▣	
f		0.1 – 0.35			
a _p		0.4 – 4.0			

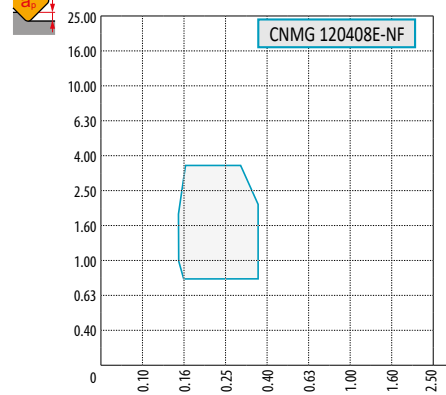
? CNMG, DNMG, SNMG, TNMG, VNMG, WNMG



GEOMETRY OF CUTTING NEGATIVE INSERTS – CLAMPING DESIGNATION ISO P, M, K, N, S, H

NM

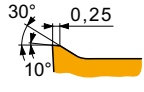
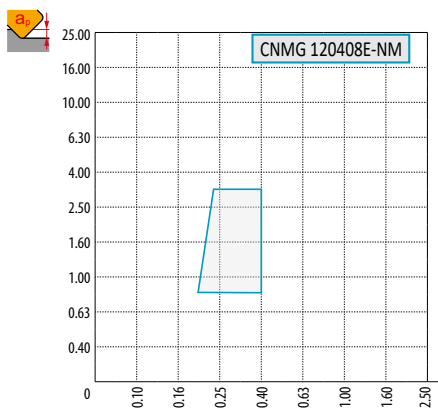
P	M	K	N	S	H
■	■	■	☑	■	■
f → 0.15 – 0.55					
a _p ↓ 0.5 – 8.0					

? CNMG, DNMG, TNMG, VNMG, WNMG

NMR

P	M	K	N	S	H
■	■	■	☑	■	■
f → 0.18 – 0.70					
a _p ↓ 0.4 – 8.0					

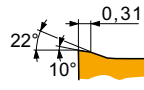
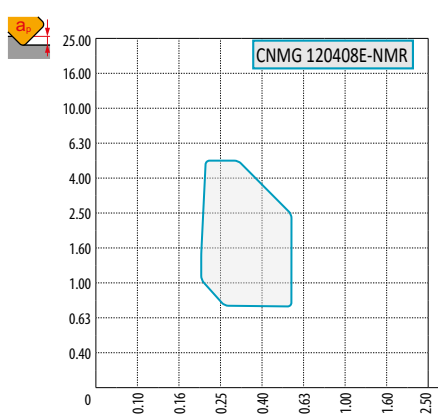
? CNMG, DNMG, SNMG, TNMG, VNMG, WNMG

R

P	M	K	N	S	H
■	■	■	☑	■	■
f → 0.25 – 0.80					
a _p ↓ 2.0 – 9.0					

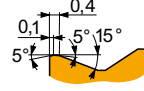
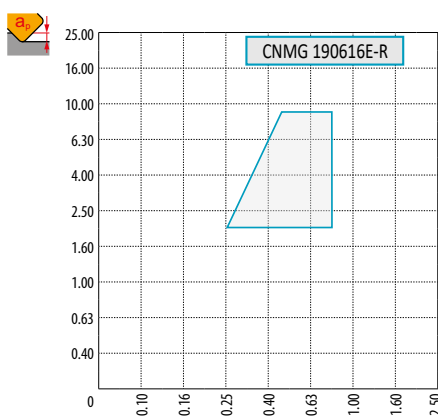
? CNMG, DNMG, SNMG, TNMG, WNMG

SF



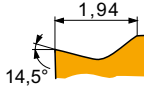
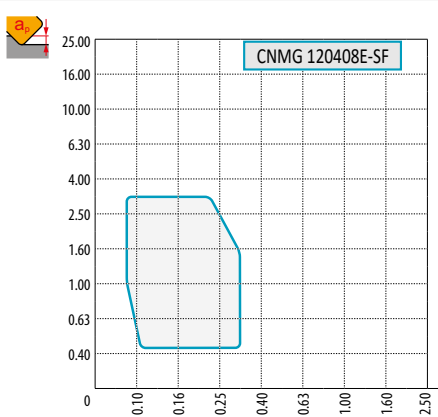

P	M	K	N	S	H
■	■	■	☑	■	■
f → 0.08 – 0.35					
a _p ↓ 0.2 – 3.5					

? CNGG, CNMG, DNMG, SNMG, TNMG, VNMG, WNMG

GEOMETRY OF CUTTING NEGATIVE INSERTS – CLAMPING DESIGNATION ISO P, M, D

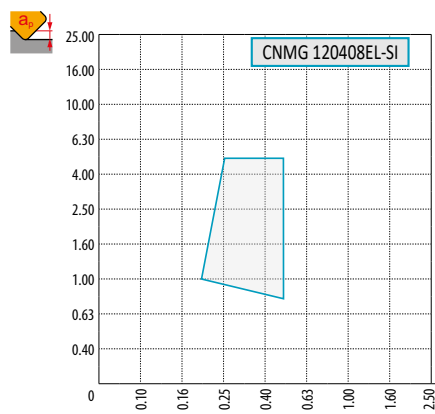
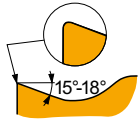
SI





P	M	K	N	S	H
■	■	■	▣	▣	
f	0.20 – 0.50				
a_p	0.8 – 5.0				
?	CNMG, DNMG, TNMG, WNMG				

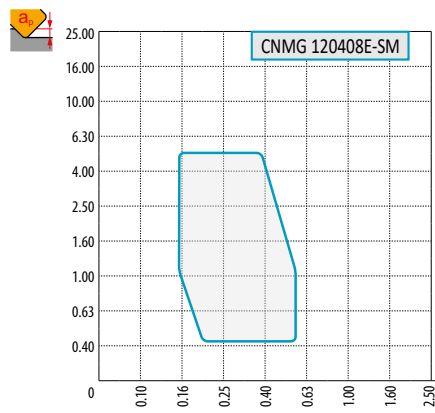
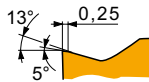

SM



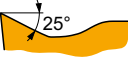
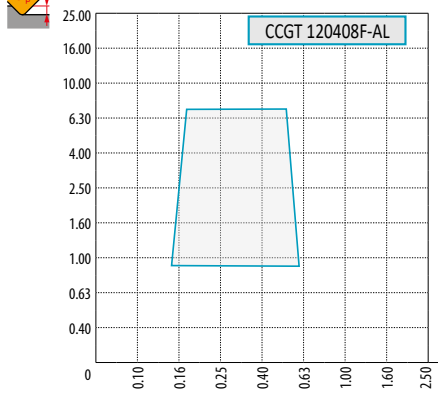



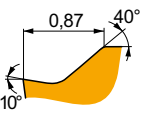
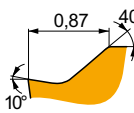

P	M	K	N	S	H
■	■	■	▣	■	▣
f	0.15 – 0.55				
a_p	0.4 – 6.0				
?	CNMG, DNMG, SNMG, TNMG, VNMG, WNMG				

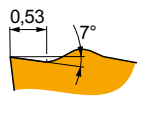
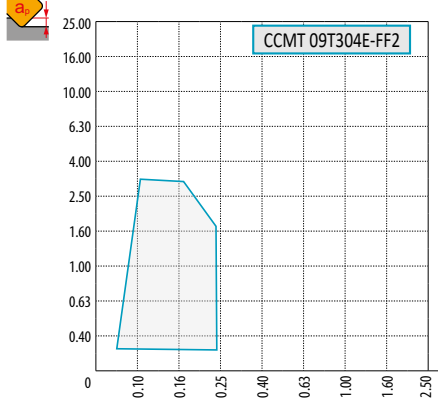
GEOMETRY OF CUTTING POSITIVE INSERTS – CLAMPING DESIGNATION ISO S

AL			P	M	K	N	S	H			
			<table border="1"> <tr> <td>f</td> <td>0.05 – 0.60</td> </tr> <tr> <td>a_p</td> <td>0.2 – 7.0</td> </tr> </table>	f	0.05 – 0.60	a_p	0.2 – 7.0				
f	0.05 – 0.60										
a_p	0.2 – 7.0										

FF			P	M	K	N	S	H			
			<table border="1"> <tr> <td>f</td> <td>0.05 – 0.23</td> </tr> <tr> <td>a_p</td> <td>0.2 – 2.0</td> </tr> </table>	f	0.05 – 0.23	a_p	0.2 – 2.0				
f	0.05 – 0.23										
a_p	0.2 – 2.0										

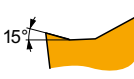
FF2			P	M	K	N	S	H			
			<table border="1"> <tr> <td>f</td> <td>0.02 – 0.28</td> </tr> <tr> <td>a_p</td> <td>0.20 – 3.0</td> </tr> </table>	f	0.02 – 0.28	a_p	0.20 – 3.0				
f	0.02 – 0.28										
a_p	0.20 – 3.0										

FM			P	M	K	N	S	H			
			<table border="1"> <tr> <td>f</td> <td>0.05 – 0.45</td> </tr> <tr> <td>a_p</td> <td>0.2 – 4.0</td> </tr> </table>	f	0.05 – 0.45	a_p	0.2 – 4.0				
f	0.05 – 0.45										
a_p	0.2 – 4.0										

GEOMETRY OF CUTTING POSITIVE INSERTS – CLAMPING DESIGNATION ISO S

FM2

P	M	K	N	S	H
■	▣	■	■	■	■
f	0.04 – 0.4				
a_p	0.2 – 4.0				

? CCMT, DCMT, ECMT, SCMT, TCMT, VBMT, VCGT

NF1

P	M	K	N	S	H
■	■	■	▣	■	▣
f	0.04 – 0.35				
a_p	0.3 – 3.5				

? CCGT, DCGT, SCGT, TCGT

NF2

P	M	K	N	S	H
▣	■	▣	▣	■	■
f	0.05 – 0.45				
a_p	0.2 – 4.0				

? CCMT, EPMT, SCMT, TCMT, VCGT

RF

l. C.	R
6,35	1,0
9,525	1,5
12,7	2,5



P	M	K	N	S	H
■	▣	■	■	■	▣
f	0.10 – 0.60				
a_p	0.8 – 8.0				

? CCMT, DCMT, SCMT, TCMT, WCMT

GEOMETRY OF CUTTING POSITIVE INSERTS – CLAMPING DESIGNATION ISO S

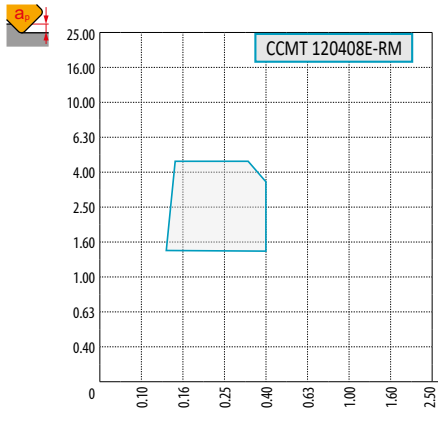

RM

P	M	K	N	S	H
■	■	■	■	■	■
f	0.10 – 0.50				
a_p	0.8 – 4.5				
					
					
 CCMT, DCMT, SCMT, TCMT, VBMT					

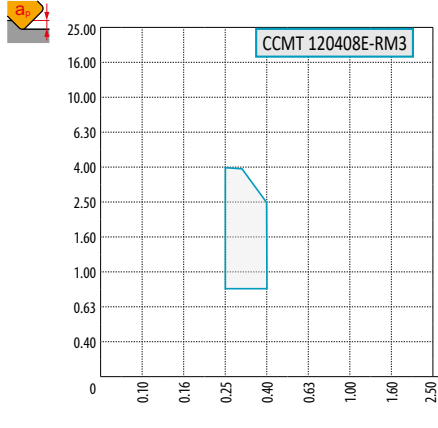

RM3

P	M	K	N	S	H
■	■	■	■	■	■
f	0.15 – 0.90				
a_p	0.4 – 6.00				
					
					
 CCMT, SCMT, TCMT, RCMT					

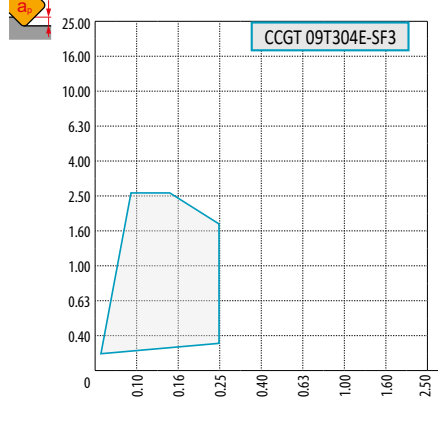

SF3

P	M	K	N	S	H
■	■	■	■	■	■
f	0.02 – 0.35				
a_p	0.2 – 4.00				
					
					
 CCGT, DCGT, ECGT, SCGT, TCGT, VCGT					

SI

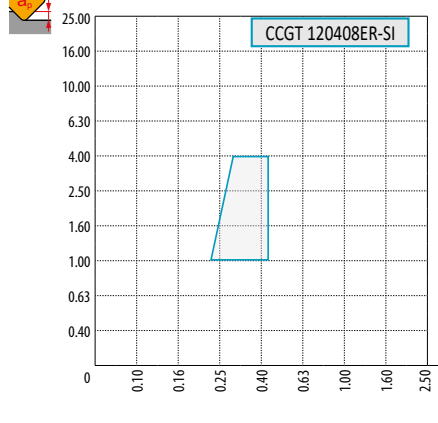



P	M	K	N	S	H
■	■	■	■	■	■
f	0.08 – 0.45				
a_p	0.4 – 4.0				
					
					
 CCGT, TCGT					





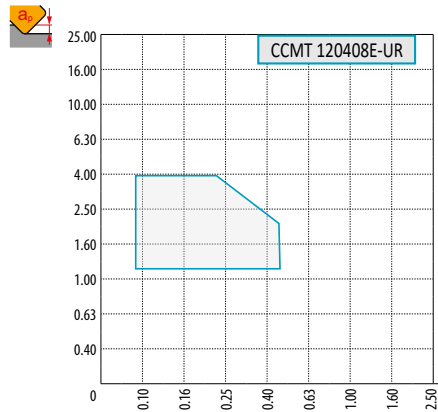
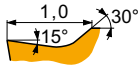

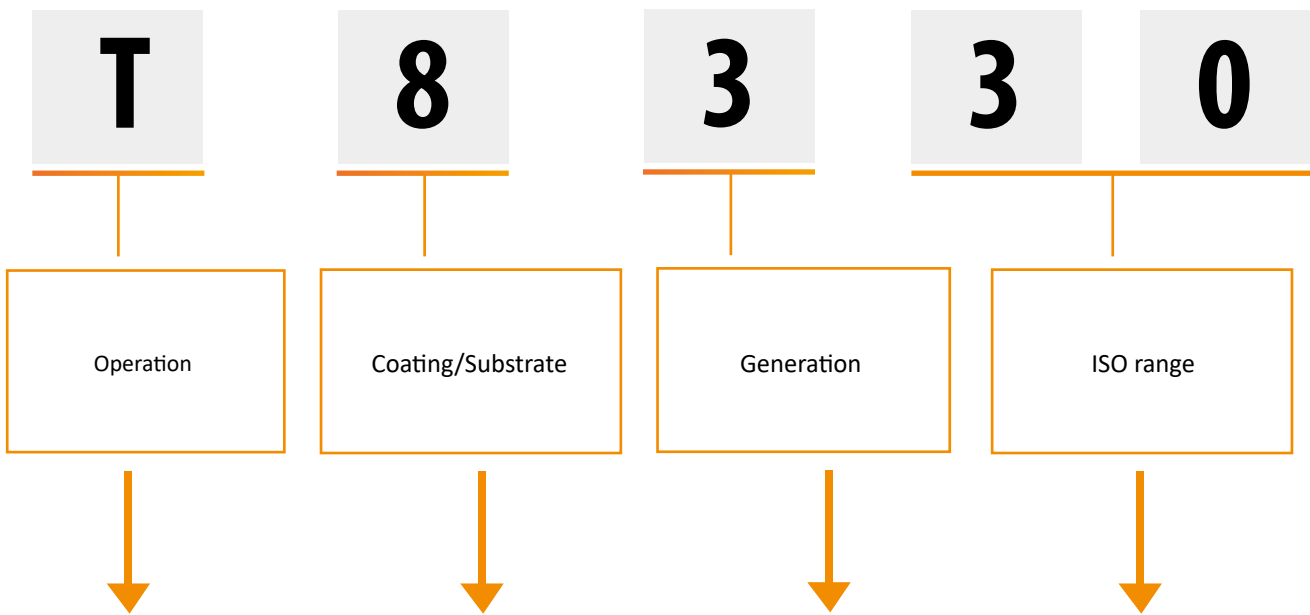

GEOMETRY OF CUTTING POSITIVE INSERTS – CLAMPING DESIGNATION ISO S

UR



P	M	K	N	S	H
■	▣	■	■	■	■
	0.10 – 0.40				
	1.0 – 4.0				
	CCMT, DCMT, RCMT, SCMT, TCMT, VCMT, VBMT, WCMT				



D	Drilling	0 PVD 1 CVD	Special application	1 – 9	01 – 50
M	Milling	2 PVD 3 CVD	Free		 01 – 05
T	Turning	4 PVD 5 CVD	Group K, H		 05 – 10
G	Grooving and Parting off	6 PVD 7 CVD	Group M, S		 10 – 20
		8 PVD 9 CVD	Universal		 20 – 30
		B	CBN		 30 – 40
		C	Ceramic		 40 – 50
		D	PCD		
		T	Cermet		



BORING GRADES

Grade Identification	Area of Application	Application	Feed	Cutting speed	Resistance to adverse Working Conditions	Coating	Colour	Substrate	Coolant benefit	Grade description
T9315	P05 - P25	<input type="checkbox"/>				MT-CVD		FGM	++	A versatile grade with excellent wear resistance properties even under intense cutting conditions. It can also be used for operations with interrupted cuts. With its well balanced properties this grade can be first choice for a wide range of turning operations. Not suited to low cutting speeds.
	K05 - K25	<input checked="" type="checkbox"/>								
	H10 - H20	<input checked="" type="checkbox"/>								
T9325	P15 - P35	<input type="checkbox"/>				MT-CVD		FGM	++	From a technological perspective this is an extremely versatile grade with high resistance to mechanical damage in adverse cutting conditions and retains excellent wear resistance. The correct application of this material requires high cutting speeds.
	M10 - M30	<input type="checkbox"/>								
	K15 - K35	<input checked="" type="checkbox"/>								
	S10 - S20	<input checked="" type="checkbox"/>								
T9335	P20 - P45	<input type="checkbox"/>				MT-CVD		FGM	+++	One of the toughest grades which is especially suitable for adverse cutting conditions at medium to high feed rates and medium cutting speeds. Compared to its predecessors, M15 – M40 it is not only tougher, but also more abrasion resistant which will be useful when using intensive cutting conditions.
	M15 - M40	<input type="checkbox"/>								
	S15 - S25	<input checked="" type="checkbox"/>								
T7325	P15 - P35	<input checked="" type="checkbox"/>				MT-CVD		FGM	+++	One of the most universal turning grades. Especially designed for stainless steel machining. Optimal balance between wear resistance and performance reliability. Suitable for broad variety of application in turning operations.
	M10 - M25	<input type="checkbox"/>								
	S10 - S25	<input type="checkbox"/>								
T7335	P20 - P40	<input checked="" type="checkbox"/>				MT-CVD		FGM	+++	Grade with functionally graded substrate, featuring very high operational reliability and very good wear-resistance. It is best suited to use in the machining of very tough M20 – M40 materials.
	M20 - M40	<input type="checkbox"/>								
	S15 - S25	<input type="checkbox"/>								
T5305	P05 - P15	<input checked="" type="checkbox"/>				MT-CVD		H	+	Grade with very high resistance to chemical wear; suitable for finishing operations using high cutting speeds. With its high abrasion resistance, it is also suitable for productive K01 – K15, machining of hardened and treated materials.
	K01 - K15	<input type="checkbox"/>								
	H05 - H15	<input checked="" type="checkbox"/>								
T5315	P10 - P25	<input checked="" type="checkbox"/>				MT-CVD		H	+	Grade intended primarily for productive machining which has high abrasion resistance and good operational reliability. Due to its properties, this material is particularly suitable for roughing and finishing operations for good or slightly adverse cutting conditions.
	K10 - K25	<input type="checkbox"/>								
	H15 - H25	<input checked="" type="checkbox"/>								
T0315	N05 - N20	<input type="checkbox"/>				PVD			++	Submicron grade for turning non-ferrous metals and their alloys with a balance of wear resistance and toughness. It is provided with a unique coating with excellent friction properties.
T6310	P01 - P15	<input type="checkbox"/>				PVD		ultra submicron H	+++	High wear resistant turning grade with top PVD coating. Suitable for finishing operation and applications, where sharp cutting edge together with high flank wear resistance is of high importance
	M01 - M15	<input type="checkbox"/>								
	K05 - K20	<input type="checkbox"/>								
	N05 - N20	<input type="checkbox"/>								
	S01 - S15	<input type="checkbox"/>								
T8315	P05 - P20	<input checked="" type="checkbox"/>				PVD		submicron H	++	Grade featuring excellent abrasion resistance while maintaining above average operational reliability, it is suitable for machining at medium to high cutting speeds in short chipping harder materials.
	M05 - M20	<input type="checkbox"/>								
	K05 - K25	<input type="checkbox"/>								
	N05 - N25	<input type="checkbox"/>								
	S05 - S15	<input checked="" type="checkbox"/>								



BORING GRADES

Grade Identification	Area of Application	Application	Feed	Cutting speed	Resistance to adverse Working Conditions	Coating	Colour	Substrate	Coolant benefit	Grade description
T8330	P25 - P40	■				PVD	Yellow	submicron H	+++	Undoubtedly the most versatile cutting material, this is useful for machining of all types of machined materials and is practically applicable in almost all types of turning operations. Its main benefits are its high operational reliability and very good frictional properties; it is therefore suitable for applications at medium and lower cutting speeds.
	M20 - M35	■								
	K20 - K40	■								
	N15 - N30	■								
	S15 - S25	■								
	H15 - H25	■								
T8430	P20 - P40	■				PVD	Yellow	submicron H	+++	Undoubtedly the most versatile cutting material, this is useful for machining of all types of machined materials and is practically applicable in almost all types of turning operations. Its main benefits are its high operational reliability and very good frictional properties; it is therefore suitable for applications at medium and lower cutting speeds.
	M20 - M35	■								
	K25 - K40	■								
	N15 - N30	■								
	S15 - S25	■								
	H15 - H25	■								
HF7	M10 - M20	■				×	Grey	submicron H	++	Uncoated grade which is primarily designed for machining non-ferrous metals; but can also be used for other machined materials (except steel). This material can be used in turning, milling, and even boring.
	K10 - K25	■								
	N10 - N25	■								
H07	M05 - M15	■				×	Grey	submicron H	++	Uncoated turning grade suitable for machining applications where oxidation resistance is not dominating criterion of tool life. Designed for machining of Ti-based alloys. Grade exhibits high strength of cutting edge together with good wear resistance.
	K10 - K25	■								
	N10 - N30	■								
	S01 - S20	■								
TT310	P10 - P25	■				PVD	Grey	Cermet	+ / -	Coated cermet used for fine and finish turning of carbon and alloy steels (including stainless). Its excellent friction properties are further improved by the coating applied using the PVD technique.
	M15 - M25	■								
TT010	P01 - P10	■				×	Grey	Cermet	+ / -	Uncoated cermet, which is suitable for fine machining of all types of steel (including stainless) at very low feed rates. Its main advantage is the minimal radius of the cutting edge and its high resistance to physical and chemical wear mechanisms.
	M01 - M10	■								
PD1	N05 - N25	■				×	Grey	PCD	-	PKD grade for turning non-ferrous materials. Ideal choice for working with high cutting speed and small feeds at stable conditions.
TB310	K01 - K10	■				×	Grey	CBN	--	CBN grade for machining of hardened materials. Suitable for machining with high cutting speed and small feeds at stable conditions.
	S05 - S10	■								
	H01 - H10	■								

Substrat

H	WC-Co baserat substrat
submicron H	WC-Co baserat substrat, finkornigt (< 1 µm)
ultra submicron H	WC-Co baserat substrat, mycket finkornigt (< 0.5 µm)
FGM	Functionally graded substrate
Cermet	Cemented carbide without WC
PCD	Polycrystalline Diamond
CBN	Cubic Boron Nitride

Coating

MT-CVD	Medium-temperature chemical method of coating
PVD	Low-temperature physical method of coating
×	Uncoated grade

Benefits of cutting fluid

+++	Use of coolant is essential
++	Highly recommended
+/-	Optional
--	Do not use coolant



TABLE OF CUTTING CONDITIONS FOR BORING

The standard turning inserts are used in the boring tools, but the conditions recommended for turning do not apply here (data given on the boxes), so please select the cutting conditions according to the following table.

WMG	Finish boring (with single insert)				Rough boring (with double inserts)			
	Diameter	Cutting speed v_c	Feed f_z	Cutting depth a_p	Diameter	Cutting speed v_c	Feed f_z	Max. cutting depth $a_{p\max}$
P	24 – 30	110 – 140	0.05 – 0.15	0.05 – 0.30	24 – 30	110 – 140	0.15 – 0.25	4.2
	29 – 40				105 – 140	0.15 – 0.30	5.7	
	39 – 50	115 – 150	0.10 – 0.20	0.20 – 0.30		6.3		
	49 – 102			0.25 – 0.35				
	100 – 220		0.30 – 0.40					
	220 – 500							
M	24 – 30	70 – 110	0.07 – 0.15	0.12 – 0.35	24 – 30	69 – 90	0.12 – 0.20	4.2
	29 – 40				80 – 110	0.15 – 0.25	5.7	
	39 – 50	80 – 110	0.12 – 0.20	0.20 – 0.30		6.3		
	49 – 102			0.25 – 0.35				
	100 – 220		0.25 – 0.35					
	220 – 500							
K	24 – 30	70 – 110	0.07 – 0.15	0.12 – 0.35	24 – 30	60 – 110	0.20 – 0.30	4.2
	29 – 40				0.25 – 0.35		5.7	
	39 – 50	80 – 115	0.20 – 0.50	6.3				
	49 – 102				0.30 – 0.40			
	100 – 220		0.12 – 0.20		0.30 – 0.45			
	220 – 500				0.25 – 0.75			
N	24 – 30	150 – 300	0.05 – 0.15	0.12 – 0.35	24 – 30	120 – 300	0.20 – 0.30	4.2
	29 – 40				150 – 360	0.25 – 0.35	5.7	
	39 – 50	150 – 360	0.10 – 0.20	0.30 – 0.40		6.3		
	49 – 102			0.30 – 0.45				
	100 – 220		0.10 – 0.25	0.30 – 0.40				
	220 – 500			0.25 – 0.75				
S	24 – 30	30 – 40	0.07 – 0.15	0.12 – 0.35	24 – 30	25 – 35	0.12 – 0.20	4.2
	29 – 40				30 – 45	0.15 – 0.25	5.7	
	39 – 50	30 – 45	0.10 – 0.20	6.3				
	49 – 102				0.20 – 0.50			
	100 – 220		0.25 – 0.75					
	220 – 500							
H	24 – 30	30 – 40	0.07 – 0.15	0.12 – 0.35	24 – 30	25 – 35	0.12 – 0.20	4.2
	29 – 40				30 – 45	0.15 – 0.25	5.7	
	39 – 50	30 – 45	0.20 – 0.50	6.3				
	49 – 102				0.20 – 0.30			
	100 – 220		30 – 45		0.20 – 0.35			
	220 – 500				0.25 – 0.75			



INSTRUCTIONS FOR USE

Adjustment instructions – roughing heads

- Mount new inserts into pockets.
- Loosen slide block locking screw(s) and tighten very lightly.
- Turn adjusting screw to move slide blocks to smaller than required diameter.
- Reverse rotation on adjusting screw and set slide blocks to required diameter.
- Setting can be done with head and holder mounted in machine, out of machine or in a tool pre-setter.
- Tighten locking screw(s) in a tool pre-setter.



For heads sizes 68 and larger (cartridge style)

- Cartridges have individual radial adjusting screws.
- Loosen the lock screw of one of the two cartridges.
- By turning the adjusting (socket head set) screw, set the cartridge until both inserts are centre. ($R1 = R2$)".

Adjustment instructions – finishing heads

- All Finish and Micro heads have micrometer adjustment with 0.002 mm graduation.
- Mount new inserts into pockets.
- Setting should be done preferably in comparator or tool pre-setter
- Loosen slide block locking screw(s) and tighten very lightly.
- Turn adjusting screw to move slide block to smaller than required diameter.
- Reverse rotation on adjusting screw and set slide block to required diameter by lining up insert O.D. corner with cross hair.
- Tighten locking screw(s).
- On applications which may present a challenge to holding a specified hole tolerance, we recommend to set the head initially to a smaller diameter, bore a hole and measure. Then adjust by the appropriate amount using the micrometer dial on the head and make another pass.





Lead angle choice

75°



90°



- Through holes.
- Heavy roughing at elevated feed rates.
- Tendency to follow existing hole (core shift, out of location?).
- Deep holes – long boring tools (self-centering effect helps on entry!).

- Blind holes.
- Step bores with 90° shoulder.
- Shallow holes – short boring tools (straightening and re-locating shifted holes).
- Boring with staggered cartridges (size 68 and larger).

These types of boring heads can be equipped with one symmetrical cartridge and one staggered cartridge. Note that staggered cartridges have a letter "S" at the end of the description.

Examples: 2CT 90 402 N S; 2CT 90 300 S; 2CT 90 402 S.

Symmetrical boring

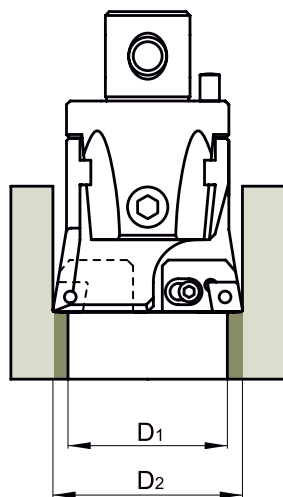

2CT □□ □□□ + 2CT □□ □□□
 3CT □□ □□□ + 3CT □□ □□□

Staggered boring

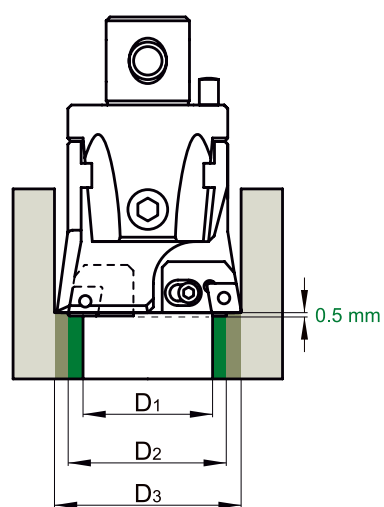

2CT □□ □□□ S + 2CT □□ □□□
 3CT □□ □□□ S + 3CT □□ □□□

Staggered boring allows an increase in metal removal rate between D1 and D3 during one pass, approximately 4 to 6 mm compared with symmetrical boring. Be aware that for staggered boring the feed per minute should be calculated as for a **single tooth tool**.



ASSEMBLY SYSTEM FOR LARGE BORING HEADS

Attention: During the entire mounting process the brake screw (pos. 2) must be released.

How to fit the large diameter boring head on the taper

Remove the position screws (pos. 1) and push along the slides until the four coupling screw sockets appear. Put together the taper face with the four screw sockets over the head's back end, then fit and tighten the 4 coupling screws.

FINISHING

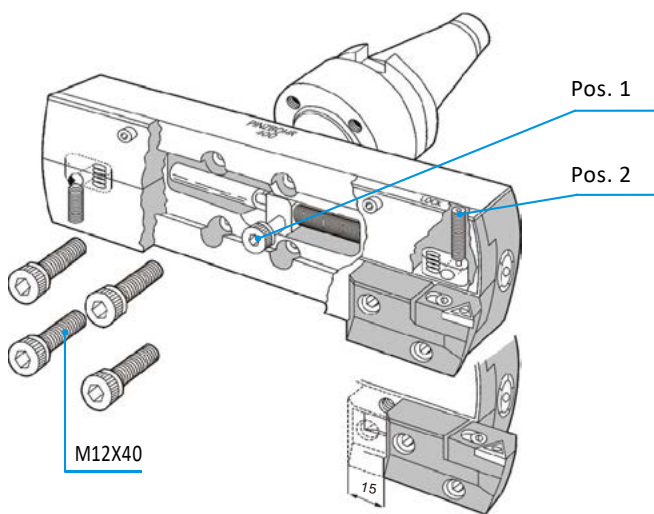

Speeds and feeds

Ultimate or optimum speeds and feeds will depend upon material, machine and setup conditions, as well as tool overhang.

Boring depth – tool overhang for roughing and finishing

Under conditions suited for carbide tooling depths of $5 \times \varnothing$ for rough boring and $3 \times \varnothing$ for finish boring are achievable. With the increasing overhang, the mechanical stability of the tool body decreases. Over-length tools will have a tendency for deflections as well as harmonic (high pitch) chatter. Harmonic chatter can cause movement of adjusting components inside the boring head leading to off-size or tapered holes.

In many cases the high pitch harmonic chatter can be dampened by increasing the feed and (or) lowering the cutting speed.

Please note that the cutting behavior will also change with the amount of slide block (insert holder) extension from the boring head requiring adjustments regarding speeds and feeds.

Boring depth – tool overhang for micro boring heads

The maximum boring depth with steel boring bars should not exceed $5 \times$ bar diameter and $7 \times$ bar diameter with solid carbide bars. We recommend to shorten the bars to the shortest overhang necessary according to the required boring depth.

For heavy duty roughing applications the largest available corner radius should be selected unless otherwise specified. For finish boring with very little stock removal the smallest available corner radius is most advantageous to minimize lateral tool deflection. This can be especially important on applications involving long overhangs.

Mounting the slides on the head

Insert both slides into the V guides, push them along until they face the nut thread holes. Fit the screws (pos. 1) and tighten them lightly. The function of these screws is dual, fixing the slide into the V guides and linking both the slide with the bronze lead nut. Finally check that the slide (slides in roughing) glides smoothly.

ROUGHING

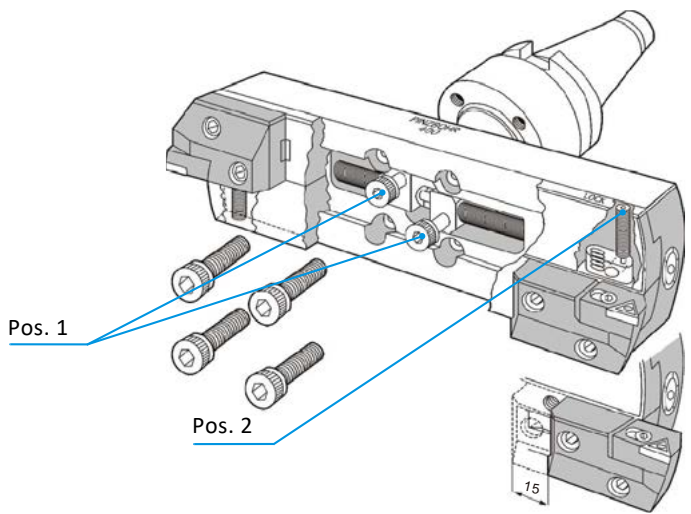

Rough boring head 75° vs. 90°

The 75° rough boring head should be used whenever a lot of stock is being removed and no square shoulder is required inside blind or stepped bores. The 75° lead has a tendency to self-centre to the pre-existing hole and therefore are very stable. If this pre-existing hole is off-centre, shifted or off-angle then it is recommended to use the 90° boring head since the 90° lead angle will have less tendency to follow the pre-existing hole.

Amount of stock removal

The maximum stock removal for rough boring may have to be decreased on very tough materials, extended overhangs as well as for extended slide blocks.

Insert corner radius

For heavy duty roughing applications the largest available corner radius should be selected unless otherwise specified. For finish boring with very little stock removal the smallest available corner radius is most advantageous to minimize lateral tool deflection. This can be especially important on applications involving long overhangs.

4 Cutting edges per insert

The 80° diamond shaped insert normally provides two cutting edges. However, all four cutting edges can be used if a 75° and a 90° rough boring head within the same size range is utilized. The same is possible between a 75° rough boring head and a 90° finish boring head.





SIMPLY RELIABLE

As a professional you can judge the quality of work by just looking at the chip. Our chip is a clean and uncomplicated shape that in itself tells a story. It is a clear and consistent signal and that's why we use it as a symbol for being **Simply Reliable**.

DORMER PRAMET

Austria

T: +31 10 2080 240
info.at@dormerpramet.com

Belgium & Luxembourg

T: +32 3 440 59 01
info.be@dormerpramet.com

Brazil

T: +55 11 5660 3000
info.br@dormerpramet.com

Canada

T: (888) 336 7637
En Français: (888) 368 8457
cs.canada@dormerpramet.com

China

T: +86 21 2416 0508
info.cn@dormerpramet.com

Croatia

T: +385 98 407 489
info.hr@dormerpramet.com

Czech Republic

T: +420 583 381 111
info.cz@dormerpramet.com

Denmark

T: 808 82106
info.se@dormerpramet.com

Finland

T: 0205 44 7003
info.fi@dormerpramet.com

France

T: +33 (0)2 47 62 57 01
info.fr@dormerpramet.com

Germany

T: +49 9131 933 08 70
info.de@dormerpramet.com

Hungary

T: +36-96 / 522-846
info.hu@dormerpramet.com

India

T: +91 11 4601 5686
info.in@dormerpramet.com

Italy

T: +39 02 30 70 54 44
info.it@dormerpramet.com

Kazakhstan

T: +7 771 305 11 45
info.kz@dormerpramet.com

Mexico

T: +52 (555) 7293981
cs.mexico@dormerpramet.com

Netherlands

T: +31 10 2080 240
info.nl@dormerpramet.com

Norway

T: 800 10 113
info.se@dormerpramet.com

Poland

T: +48 32 78-15-890
info.pl@dormerpramet.com

Portugal

T: +351 21 424 54 21
info.pt@dormerpramet.com

Romania

T: +4(0)730 015 885
info.ro@dormerpramet.com

Russia

T: +7 (495) 775 10 28
info.ru@dormerpramet.com

Slovakia

T: +421 (41) 764 54 60
info.sk@dormerpramet.com

Slovenia

T: +385 98 407 489
info.si@dormerpramet.com

Spain

T: +34 935717722
info.es@dormerpramet.com

Sweden

responsible for Iceland
T: +46 35 16 52 96
info.se@dormerpramet.com

Switzerland

T: +31 10 2080 240
info.ch@dormerpramet.com

Turkey

T: +90 533 212 45 47
info.tr@dormerpramet.com

Ukraine

T: +38 067 566 38 80
T: +38 067 566 81 51
info.ua@dormerpramet.com

United Kingdom

responsible for Ireland
T: 0870 850 4466
info.uk@dormerpramet.com

United States of America

T: (800) 877-3745
cs@dormerpramet.com

Other countries

South America

T: +55 11 5660 3000
info.br@dormerpramet.com

Adria

T: +420 583 381 527
info.rcee@dormerpramet.com

Rest of the World

Dormer Pramet International UK
T: +44 1246 571338
info.int@dormerpramet.com

Dormer Pramet International CZ
T: +420 583 381 520
info.int.cz@dormerpramet.com

DP-CAT-HOLEMAKING-2021-EN

FOLLOW US...



www.dormerpramet.com



youtube.com/dormerpramet



facebook.com/dormerprametsocial



linkedin.com/company/dormerpramet



instagram.com/dormerprametsocial



twitter.com/dormerpramet